

strybuc
INDUSTRIES

WINDOW AND DOOR HARDWARE

THE ONE STOP SOURCE FOR ALL YOUR WINDOW & DOOR HARDWARE

Shower Door
HARDWARE



2025

ONLINE PARTS STORE PROGRAM

strybuc//connect



**SELL 40,000+ PARTS
24 HOURS A DAY,
7 DAYS A WEEK.**

- Your "custom" online store comes pre-loaded with thousands of products to sell.
- Set your own selling prices.
- Upload your own logo, identity, and branding.
- Apply today by going to our Forms Tab on Strybuc.com.
- StrybucConnect Store Types:
 - Affiliate Store: Embed into your existing website.
 - ProStore Store: Basic custom e-commerce.
 - Premium Store: Advance e-website features.

TOUCH-SCREEN WINDOW AND DOOR PARTS KIOSK FOR RETAIL STORES

THE "KIOSK- PRO" TOUCH-SCREEN "WINDOW AND DOOR PARTS" SYSTEM FOR RETAIL STORES!

Promote & sell 40,000 popular hard to find and obsolete window and door parts using the touch-screen online store and printed catalog.



| Part Number | Description |
|-------------|---|
| STR100 | Kiosk, Keyboard with Trackball & Camera |

New: Camera feature to assist in identifying obsolete or hard-to-find parts.

BLIND DROP SHIP PROGRAM

We offer a **Blind Drop Ship Program** that allows you to ship an order directly to your customer from our warehouse, without letting your customer know the source is Strybuc.

- We use generic packing slips, bags, and boxes to ship your order.
- Saves time - from our warehouse to your customer.
- Save by reducing double handling.
- Eliminate additional delivery costs.

Talk with your Account Manager for more details.



NEED SAMPLES TO TRY?? We know changing frameless shower suppliers products, can be difficult. Please Request a Sample by Contacting your Account Manager #(800)352-0800.

SHOWER DOOR HINGES

Standard Duty & Solid Brass

Square Edge

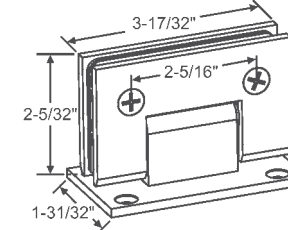

| Part Number | Finish | PVC Gasket |
|-------------|----------------|------------|
| 22-244BCH | Bright Chrome | Clear |
| *22-244BNK | Brushed Nickel | Black |

Solid brass shower hinge, stainless steel, standard full back plate, PVC gasket
Includes:
Philips screws, Allen screws & Allen key.
Wall to glass 90°
Suitable for glass 8 - 12 mm

Square Edge

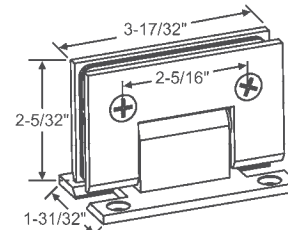

| Part Number | Finish | PVC Gasket |
|--------------|----------------|------------|
| 22-244BCH-H | Bright Chrome | Clear |
| *22-244BNK-H | Brushed Nickel | Black |

Solid brass shower hinge, stainless steel, H back plate, PVC gasket
Includes:
Philips screws, Allen screws & Allen key.
Wall to glass 90°
Suitable for glass 8 - 12 mm

Square Edge

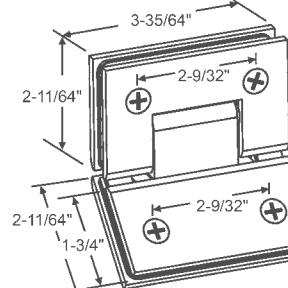

| Part Number | Finish | PVC Gasket |
|-------------|----------------|------------|
| 22-249BCH | Bright Chrome | Clear |
| *22-249BNK | Brushed Nickel | Clear |

Solid brass shower hinge, stainless steel, PVC gasket
Includes:
Philips screws, Allen screws & Allen key.
Glass to glass 135°
Suitable for glass 8 - 12 mm

Square Edge

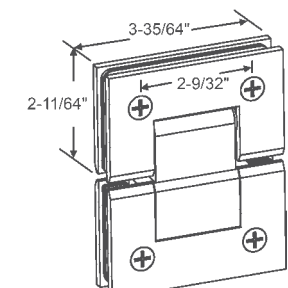

| Part Number | Finish | PVC Gasket |
|-------------|----------------|------------|
| 22-245BCH | Bright Chrome | Clear |
| *22-245BNK | Brushed Nickel | Clear |

Solid Brass Shower hinge, stainless steel, PVC gasket.
Includes:
Philips screws, Allen screws & Allen key.
Glass to glass 180°
Suitable for glass 8 - 12 mm

Beveled Edge

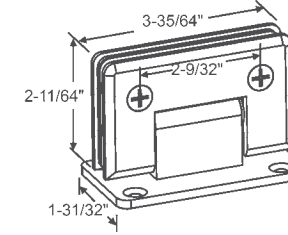

| Part Number | Finish | PVC Gasket |
|-------------|----------------|------------|
| 22-272BCH | Bright Chrome | Clear |
| *22-272BNK | Brushed Nickel | Black |

Standard duty brass shower hinge, stainless steel, full back plate, PVC gasket.
Includes:
Philips screws, Allen screws & Allen key.
Wall to glass 90°
Suitable for glass 8 - 12 mm

Beveled Edge

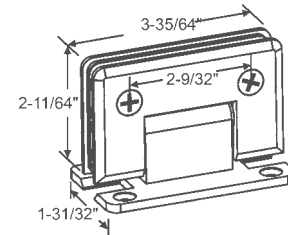

| Part Number | Finish | PVC Gasket |
|-------------|----------------|------------|
| 22-273BCH | Bright Chrome | Clear |
| *22-273BNK | Brushed Nickel | Black |

Standard duty brass shower hinge, stainless steel, H back plate, PVC gasket
Includes:
Philips screws, Allen screws & Allen key.
Wall to glass 90°
Suitable for glass 8 - 12 mm

Beveled Edge

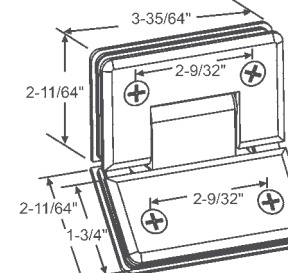

| Part Number | Finish | PVC Gasket |
|-------------|----------------|------------|
| 22-260BCH | Bright Chrome | Clear |
| *22-260BNK | Brushed Nickel | Clear |

Standard duty brass shower hinge, stainless steel, PVC gasket.
Includes:
Philips screws, Allen screws & Allen key.
Glass to glass 135°
Suitable for glass 8 - 12 mm

Beveled Edge

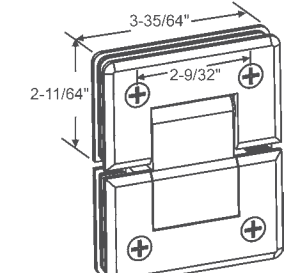

| Part Number | Finish | PVC Gasket |
|-------------|----------------|------------|
| 22-261BCH | Bright Chrome | Clear |
| *22-261BNK | Brushed Nickel | Clear |

Standard duty brass shower hinge, stainless steel, PVC gasket.
Includes:
Philips screws, Allen screws & Allen key.
Glass to glass 180°
Suitable for glass 8 - 12 mm

PHILADELPHIA

YEADON

MIAMI

OWATONNA

RENO

PHILADELPHIA: 2006 Elmwood Avenue • Sharon Hill, PA 19079 • 800-352-0800 • Sales Fax: 610-534-3202

MIAMI: 4181 West 108th Street, Suite 7 • Hialeah, FL 33018 • 800-780-5051 • Fax: 305-557-5239

STRYBUC.COM | CSERVICE@STRYBUC.COM

*While Supplies Last

SHOWER DOOR HINGES

Standard Duty & Solid Brass

Beveled Edge



| Part Number | Finish | PVC Gasket |
|-------------|----------------|------------|
| 22-259BCH | Bright Chrome | Black |
| *22-259BNK | Brushed Nickel | |

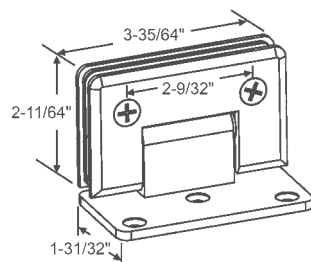

Standard duty brass shower hinge, offset back plate, PVC gasket.
Includes:
Philips screws, Allen screws & Allen key.
Wall to Glass 90°
Suitable for glass 8 - 12 mm

Beveled Edge



| Part Number | Finish | PVC Gasket |
|-------------|----------------|------------|
| *22-215BNK | Brushed Nickel | |

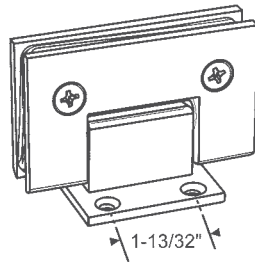

Standard duty brass shower hinge, offset back plate, PVC gasket.
Includes:
Philips screws, Allen screws & Allen key.
Wall to Glass 90°
Suitable for glass 8 - 12 mm

SHOWER DOOR HINGES

Heavy Duty & Solid Brass

Square Edge



Square Edge



| Part Number | Finish | PVC Gasket |
|--------------|----------------|------------|
| 22-246BCH-H | Bright Chrome | Clear |
| *22-246BNK-H | Brushed Nickel | Clear |

Solid brass shower hinge, heavy duty, H back plate, PVC gasket.
Includes:
Philips screws, Allen screws & Allen key.
Wall to glass 90°
Suitable for glass 10 - 12 mm

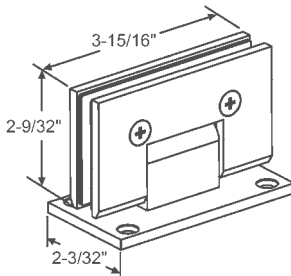

Solid brass shower hinge, heavy duty, standard full back plate, PVC gasket.
Includes:
Philips screws, Allen screws & Allen key.
Wall to glass 90°
Suitable for glass 10 - 12 mm

| Part Number | Finish | PVC Gasket |
|-------------|----------------|------------|
| 22-246BCH | Bright Chrome | Clear |
| *22-246BNK | Brushed Nickel | Clear |

Square Edge



| Part Number | Finish | PVC Gasket |
|-------------|----------------|------------|
| 22-247BCH | Bright Chrome | Clear |
| *22-247BNK | Brushed Nickel | Clear |

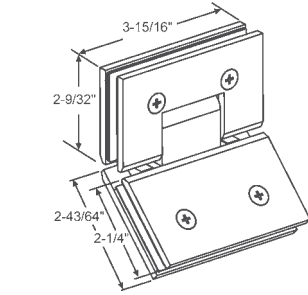

Heavy duty brass shower hinge, PVC gasket.
Includes:
Philips screws, Allen screws & Allen key.
135° Glass to Glass
Suitable for 10 - 12 mm glass

Square Edge



| Part Number | Finish | PVC Gasket |
|-------------|----------------|------------|
| 22-248BCH | Bright Chrome | Clear |
| *22-248BNK | Brushed Nickel | Black |

Heavy duty brass shower hinge, PVC gasket.
Includes:
Philips screws, Allen screws & Allen key.
180° Glass to Glass
Suitable for 10 - 12 mm glass

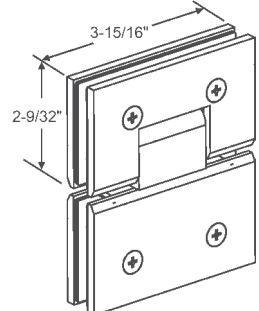

Beveled Edge



| Part Number | Finish | PVC Gasket |
|-------------|----------------|------------|
| 22-269BCH | Bright Chrome | Clear |
| *22-269BNK | Brushed Nickel | Clear |

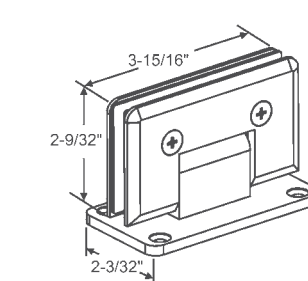

Solid brass shower hinge, heavy duty, full back plate, PVC gasket.
Includes:
Philips screws, Allen screws & Allen key.
Wall to glass 90°
Suitable for glass 10 - 12 mm

SHOWER DOOR HINGES

Heavy Duty & Solid Brass

Beveled Edge



| Part Number | Finish | PVC Gasket |
|-------------|----------------|------------|
| 22-271BCH | Bright Chrome | Clear |
| *22-271BNK | Brushed Nickel | Black |

Solid brass shower hinge, heavy duty, H back plate, PVC gasket.
Includes:
Philips screws, Allen screws & Allen key.
Wall to glass 90°
Suitable for glass 10 - 12 mm

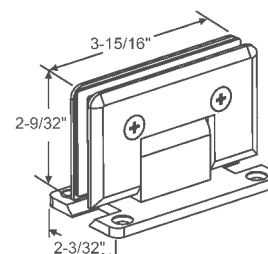

Beveled Edge



| Part Number | Finish | PVC Gasket |
|-------------|----------------|------------|
| 22-270BCH | Bright Chrome | Clear |
| *22-270BNK | Brushed Nickel | Black |

Solid brass shower hinge, heavy duty, PVC gasket.
Includes:
Philips screws, Allen screws & Allen key.
180° Glass to Glass
Suitable for 10 - 12 mm glass

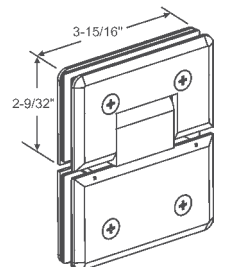

SHOWER DOOR HINGES

Adjustable Hinges



| Part Number | Finish |
|-------------|----------------|
| 22-301CH | Bright Chrome |
| *22-301BN | Brushed Nickel |

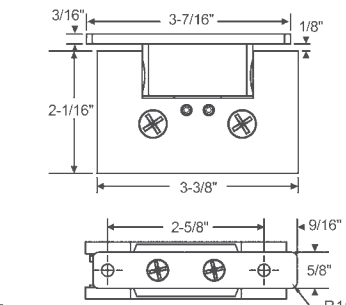

Adjustable Solid Brass Top Pivot Hinge
Solid Brass



| Part Number | Finish | PVC Gasket |
|-------------|----------------|------------|
| 22-302CH | Bright Chrome | Black |
| *22-302BN | Brushed Nickel | Black |

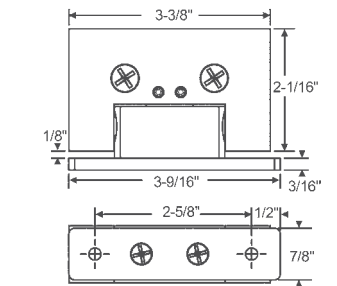

Adjustable Bottom Pivot Hinge Solid Brass



| Part Number | Finish |
|-------------|----------------|
| 22-303CH | Bright Chrome |
| *22-303BN | Brushed Nickel |

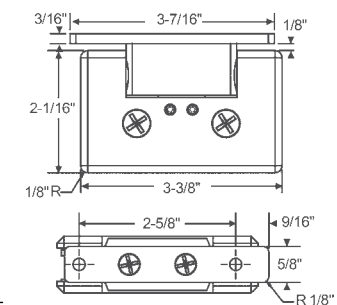

Adjustable Top Pivot Hinge with Radius Corners & Chamfered Edges



| Part Number | Finish | PVC Gasket |
|-------------|----------------|------------|
| 22-305CH | Bright Chrome | Black |
| *22-305BN | Brushed Nickel | Black |

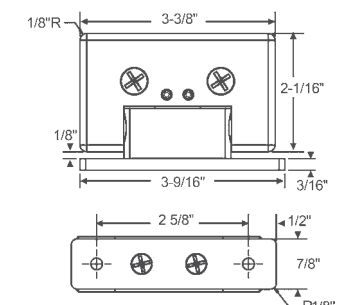

Adjustable Bottom Pivot Hinge Radius Corners & Chamfered Edges

SHOWER DOOR GLASS CLAMPS

Glass Clamps

Rounded Edge

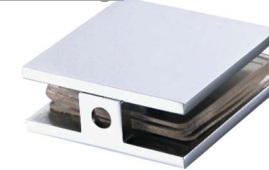

| Part Number | Finish |
|-------------|----------------|
| 22-262BCH | Bright Chrome |
| *22-262BNK | Brushed Nickel |

Brass shower glass clamp, clear PVC gasket.
Includes:
Philips screws, Allen screws & Allen key.
Wall to glass, hole-in-glass style.
Suitable for glass 8 - 12 mm.

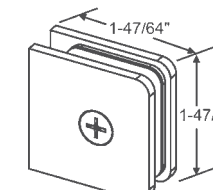

Square Edge



| Part Number | Finish |
|-------------|----------------|
| 22-257BCH | Bright Chrome |
| *22-257BNK | Brushed Nickel |

Solid brass shower glass clamp, clear PVC gasket.
Includes:
Philips screws, Allen screws & Allen key.
Wall to glass, hole-in-glass style.
Suitable for glass 8 - 12 mm.

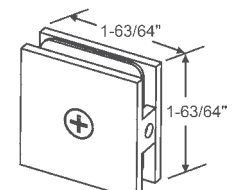

SHOWER DOOR GLASS CLAMPS

Square Edge



| Part Number | Finish |
|-------------|----------------|
| 22-258BCH | Bright Chrome |
| *22-258BNK | Brushed Nickel |

Solid brass shower glass clamp, clear PVC gasket.
Includes:
Philips screws, Allen screws & Allen key.
Glass to glass 90°
Suitable for glass 8 - 12 mm

Square Edge



| Part Number | Finish |
|-------------|----------------|
| 22-263BCH | Bright Chrome |
| *22-263BNK | Brushed Nickel |

Brass shower glass clamp, clear PVC gasket.
Includes:
Philips screws, Allen screws & Allen key.
Wall to glass 90°, with large leg.
Suitable for glass 8 - 12 mm

Square Edge



| Part Number | Finish |
|-------------|----------------|
| 22-264BCH | Bright Chrome |
| *22-264BNK | Brushed Nickel |

Brass shower glass clamp, clear PVC gasket.
Includes:
Philips screws, Allen screws & Allen key.
Glass to glass 180°
Suitable for glass 8 - 12 mm

Beveled Edge



| Part Number | Finish |
|-------------|----------------|
| 22-256BCH | Bright Chrome |
| *22-256BNK | Brushed Nickel |

Solid brass shower glass clamp, clear PVC gasket.
Includes:
Philips screws, Allen screws & Allen key.
Wall to glass, hole-in glass style.
Suitable for glass 8 - 12 mm

SHOWER DOOR GLASS SLEEVE OVER GLASS CLAMPS



| Part Number | Finish | Hand |
|-------------|----------------|------|
| 22-265LBCH | Bright Chrome | LH |
| 22-265RBCH | Bright Chrome | RH |
| *22-265LBNK | Brushed Nickel | LH |
| *22-265RBNK | Brushed Nickel | RH |

Shower sleeve over wall mount glass clamp
Suitable for glass 8 - 12 mm

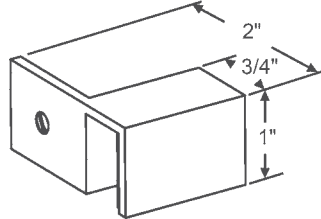

| Part Number | Finish |
|-------------|----------------|
| 22-267BCH | Bright Chrome |
| *22-267BNK | Brushed Nickel |

Shower sleeve over glass clamp
Glass to glass 90 degree
Suitable for glass 8 - 12 mm

SHOWER DOOR GLASS SEALING STRIPS

Sold by Length - 96" Length, Minimum 12 Lengths



| Part Number | Glass Thickness | A |
|-------------|-----------------|------|
| 22-280 | 10 mm | 3/8" |
| 22-281 | 12 mm | 1/2" |

PVC seal strip, glass to glass
Size: 96"



| Part Number | Glass Thickness | A |
|-------------|-----------------|------|
| 22-282 | 10 mm | 3/8" |
| 22-283 | 12 mm | 1/2" |

PVC seal strip, glass to glass
Size: 96"



| Part Number | Glass Thickness |
|-------------|-----------------|
| 22-277 | 10 mm |

PVC bulb seal strip
for 3/8" (10 mm) Glass. Size: 96"

Shower Door Hardware

SHOWER DOOR GLASS SEALING STRIPS

Sold by Length - 96" Length, Minimum 12 Lengths

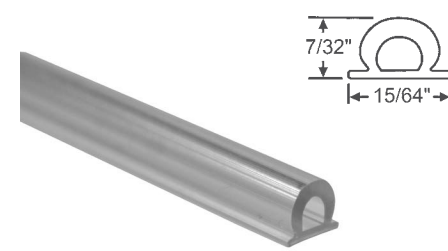

| Part Number |
|-------------|
| 22-43 |

PVC Clear 7/32" 5.5ml



| Part Number |
|-------------|
| 22-44 |

PVC Clear 5/32" 4ml Gap, Without Tap

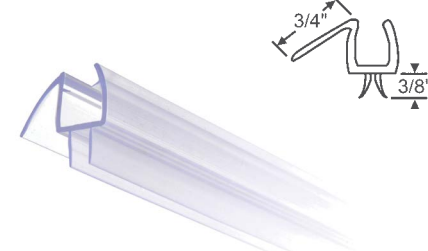

| Part Number | Glass Thickness |
|-------------|-----------------|
| 22-208-3 | 3 mm |
| 22-208-6 | 6 mm |
| 22-208 | 10 mm |

96" Clear Co Extruded Wipe



| Part Number | Glass Thickness |
|-------------|-----------------|
| 22-278 | 10 mm |

PVC bulb seal strip
for 3/8" (10 mm) Glass. Size: 96"

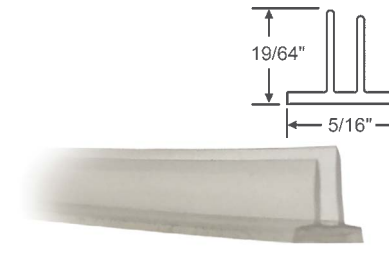

| Part Number | Glass Thickness |
|-------------|-----------------|
| 22-279 | 8 mm |

PVC double fin seal
for 5/16" (8 mm) glass. Size: 96"

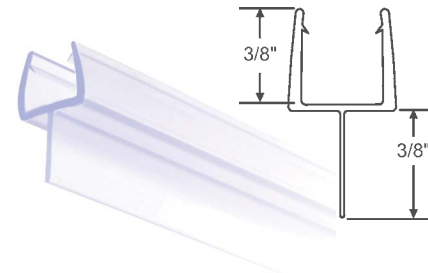

| Part Number | Glass Thickness |
|-------------|-----------------|
| 22-276 | 10 mm |

PVC bottom seal strip,
for 3/8" (10mm) glass. Size: 96"

SWEEP\$AVER™ DOOR SEAL "CUTTER" TOOL

"The Most Popular Frameless Shower Door Tool in the Industry!"

Created out of a need from a glass company that specializes in high-end complex shower door installations. The SWEEP\$AVER™ is designed to take a forty-minute job and cut it down to mere seconds, saving you time and money. The tool is created to efficiently cut vinyl soft-leg water diverters and sweeps precisely to your desired height, thus creating the finishing touch to a custom shower door.

- (6) Different cutting adjustment positions in 1/16" increments
- Designed for both right and left hand users
- Lifetime Warranty
- Made in the USA

| Part Number | Description |
|-------------|---|
| 59-187 | Dims: 12-5/8" x 7/16" x 1-15/16" Weight: 3.5 oz. Material: ABS Polymer Note: Razor Blade Not Included |
| 59-187R | Box of 100 Razor Blades |

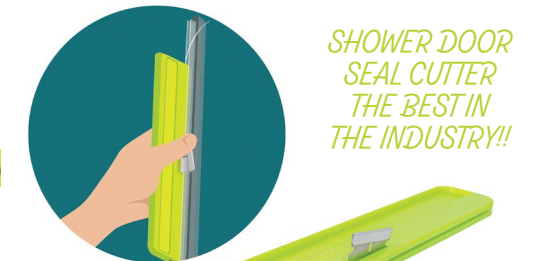

SHOWER DOOR SEAL CUTTER THE BEST IN THE INDUSTRY!!

WATCH TODAY!
Video:



SHOWER DOOR HANDLES AND PULL KNOBS



| Part Number | Finish |
|-------------|----------------|
| 22-254BCH | Bright Chrome |
| *22-254BNK | Brushed Nickel |

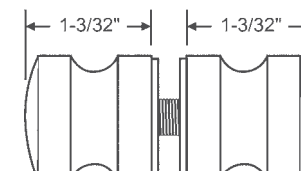

Solid brass shower door pull set.



| Part Number | Finish |
|-------------|----------------|
| 22-255BCH | Bright Chrome |
| *22-255BNK | Brushed Nickel |

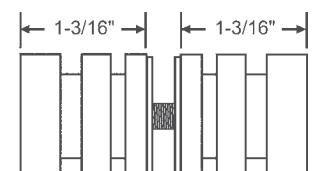

Solid brass shower door pull set.

SHOWER DOOR HANDLES AND PULL KNOBS

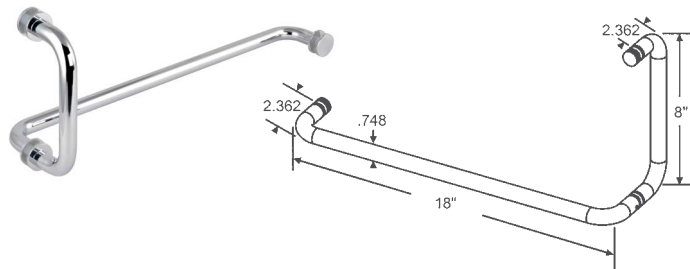

| Part Number | Finish | Description |
|-----------------|----------------|---|
| 22-253BCH-8X18 | Bright Chrome | Stainless steel shower door combo pull handle without stainless steel washers |
| *22-253BNK-8X18 | Brushed Nickel | Size: 3/4" x 8" x 18"(203 x 457 mm) with PVC washer |

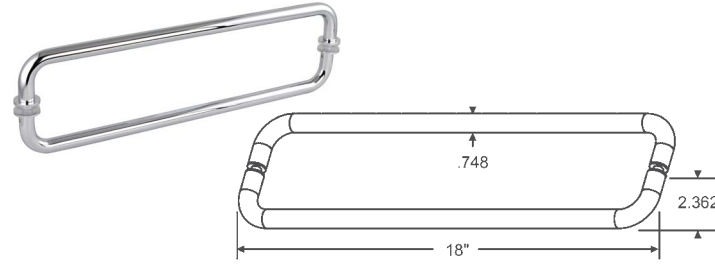

| Part Number | Finish | Description |
|---------------|----------------|--|
| 22-250BCH-18 | Brushed Chrome | Stainless steel back to back fixing towel bars without metal washers |
| *22-250BNK-18 | Brushed Nickel | Size: Dia. 3/4" x 18"(C-C) Sold in set. |



| Part Number | Finish | A | Description |
|--------------|----------------|----|---|
| 22-250BCH-6 | Bright Chrome | 6" | Stainless steel shower pull handles, with metal washers |
| *22-250BNK-6 | Brushed Nickel | 6" | Size: Dia. 3/4" x 6"(C-C) Back to Back fixing |
| 22-250BCH-8 | Bright Chrome | 8" | Sold in set. |
| *22-250BNK-8 | Brushed Nickel | 8" | |

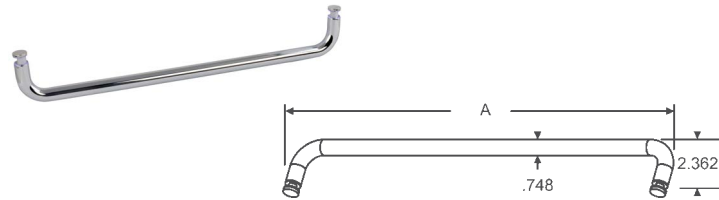
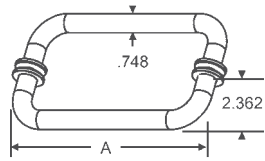

| Part Number | Finish | A | Description |
|---------------|----------------|-----|--|
| 22-252BCH-18 | Bright Chrome | 18" | Stainless steel single side towel bar, without metal washers |
| *22-252BNK-18 | Brushed Nickel | 18" | |
| 22-252BCH-24 | Bright Chrome | 24" | |
| *22-252BNK-24 | Brushed Nickel | 24" | |



| Part Number | Finish | Description |
|--------------|----------------|---|
| 22-251BCH-8 | Bright Chrome | Stainless steel shower pull handles |
| *22-251BNK-8 | Brushed Nickel | Size: Dia 3/4" x 8"(C-C) x 12" (total length) Back to back fixing |

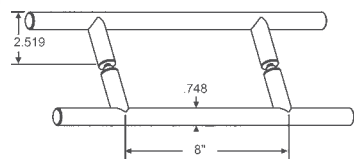

WASHER SET



| Part Number | Finish | Description |
|-------------|----------------|---|
| 22-266BCH | Bright Chrome | Stainless steel metal washer kit for 19 mm tube |
| *22-266BNK | Brushed Nickel | 4 piece metal washer and 4 piece PVC washer |

MILDEW RESISTANT SILICONE SEALANT



Kitchen & Bath Silicone

- Odorless
- 7 Years Mold-Free Protection
- 100% Waterproof
- Permanently Flexible
- Super Elastic
- Indoor Use
- Under 10 Minutes Tack Free

| | |
|---------------------------|---------------|
| Maintain Elasticity | -67°F - 302°F |
| Elongation at Break | 400% - 500% |
| Joint Movement Capability | ± 25% |

- Specialized**
- Aluminum curtainwall joint, construction interior
 - Window and door frame joint
 - Stone ceramic panel and tiles

| Part Number | Finish |
|-------------|--------|
| 59-204CL | Clear |
| 59-204W | White |

25 Per Case



General Purpose Silicone

- Odorless
- UV-Resistance
- 100% Waterproof
- Permanently Flexible
- Mold Resistance
- In/outdoor Use
- Under 10 Minutes Tack Free

| | |
|---------------------------|---------------|
| Maintain Elasticity | -67°F - 302°F |
| Elongation at Break | 300% - 350% |
| Joint Movement Capability | ± 20% |

- Specialized**
- Curtainwall joint, steel and aluminum windows
 - Wood and PVC sash
 - Brick, concrete, painted surface ect.

| Part Number | Finish |
|-------------|--------|
| 59-203CL | Clear |

25 Per Case

PHILADELPHIA YEADON MIAMI OWATONNA RENO

PHILADELPHIA: 2006 Elmwood Avenue • Sharon Hill, PA 19079 • 800-352-0800 • Sales Fax: 610-534-3202

MIAMI: 4181 West 108th Street, Suite 7 • Hialeah, FL 33018 • 800-780-5051 • Fax: 305-557-5239

STRYBUC.COM | CSERVICE@STRYBUC.COM

*While Supplies Last

Shower Door Hardware

FOAMING GLASS CLEANER



"Private Label Foaming Glass Cleaner As Your Own!!"

- Guaranteed to Leave No Film- "Streak Free"
- Industrial Strength
- Cleans Glass, Windows, Mirrors, Windshields, Enamel
- Surfaces, Chrome, Tile Porcelain and Other Hard Surfaces
- Sprays in Any Position
- Dissolves Dirt, Grease Grit and Grime
- Heavy-Duty Foam Clings to Vertical Surfaces
- Non-Ammoniated
- Contains Cosmetic-Grade Alcohol for Best Performance
- Superior Quality at Competitive Pricing
- Advanced Formulation



| Part Number | Description |
|-------------|--|
| 59-101P50 | 19 oz. can: 600 Cans per Pallet (50 Cases, 12 cans per case) |
| 59-101P450 | 4 oz. can: 600 Cans per Pallet (50 Cases, 12 cans per case) |

Free Freight (All Pallet Orders)

JUST PROVIDE US WITH YOUR LOGO AND WEBSITE AND YOU CAN HAVE YOUR OWN PRIVATE LABEL CANS. NO ARTWORK FEE.

SPRAY-X



- Industrial Strength
- Cleans glass, windows, mirrors, windshields, enamel surfaces, chrome, tile, porcelain and other hard surfaces.
- Sprays in any position (360° Valve)
- Dissolves dirt, grease, grit and grime
- Heavy-Duty Foam clings to vertical surfaces
- Non-ammoniated
- Guaranteed to leave no film - "Streak Free"
- Safe on tinted glass, plastic and mirrors
- Contains cosmetic-grade alcohol for best performance
- Cases of the Spray-X brand 19oz. Cans
- Patent Pending FormulatioN
- 12 Per Case Cans

| Part Number | Description |
|-------------|-------------------------|
| 59-101 | 19 oz. Can /25 Per Case |

When You Order 50 Cases of the Spray-X brand 19oz. Cans, You Will Receive FREE FREIGHT!

SPRAY-X QUARTER PALLET END CAP



- Premier, Contemporary Packaging
- Perfect for Consumer Retail Sales
- 48 Value Packs Per Quarter Pallet
- 6 Value Packs Per Tray
- 4 Cans Per Value Pack
- 192 Cans Per Quarter Pack
- The Most Versatile Glass Cleaner Available
- Sprays in Any Position
- Dissolves Dirt, Grease, Grit and Grime
- Heavy-Duty Foam Clings to Vertical Surfaces
- Guaranteed to Leave No Film - "Streak Free"
- Industrial Strength
- Pleasant Scent
- Premium Formula

| Part Number | Description |
|-------------|-----------------------------------|
| 59-101QP | 48 Value Packs Per Quarter Pallet |

QUARTER PALLET PROGRAM AVAILABLE!

"DOUBLE EDGE" PLASTIC SCRAPER BLADES

NEW

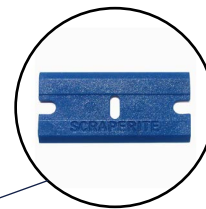

EASY REMOVAL OF ADHESIVES CALCIUM GLUE, TAR & WAX

| Part Number | Description |
|-------------|--------------------------------------|
| 59-187P | Blue Plastic Razor Blades Box of 100 |

PHILADELPHIA YEADON MIAMI OWATONNA RENO

PHILADELPHIA: 2006 Elmwood Avenue • Sharon Hill, PA 19079 • 800-352-0800 • Sales Fax: 610-534-3202

MIAMI: 4181 West 108th Street, Suite 7 • Hialeah, FL 33018 • 800-780-5051 • Fax: 305-557-5239

STRYBUC.COM | CSERVICE@STRYBUC.COM

NEW



FOR REMOVING PAINT, CAULK AND GLUE

| Part Number | Description |
|-------------|---------------------------------------|
| 59-205 | Razor Blade Scraper Includes 5 Blades |

CAULKING APPLICATORS AND SEALANT FINISHERS



30oz Caulking Gun

- 18:1 Thrust ratio
- Rotary carriage and ladder hook
- High density sintered thrust block 10mm
- Heat treated (hardened) pushing rod
- Black aluminum handle & trigger
- For high viscosity dispensing material
- Maximum pushing power: 4,000N
- For cartridges 900ml/28 fl oz
- Color: Black

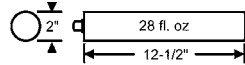

| Part Number | Description |
|-------------|--------------------------|
| 59-155NS | 30oz Caulking Applicator |



20oz Sausage Gun HPS600-A

- 12:1 Thrust ratio
- Rotary barrel
- Strong catch plate
- Stable aluminium screw caps
- Anatomically shaped trigger
- For cartridges 310ml/10.5 fl oz.
- Sausages 400ml/11.6 fl oz, 600ml/20.2 fl oz
- Color: Silver/Black

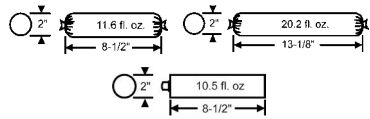

| Part Number | Description |
|-------------|-------------------------|
| 59-108 | 20oz Sausage Applicator |



20oz Sausage Gun FX7-60

- 17:1 Thrust ratio
- Professional push plate for total emptying
- Rust-resistant due to special alloy
- Rubberized handle and trigger
- Hardened thrust block (force >4000N)
- Rotatable half shell/ aluminum tube and ladder hook

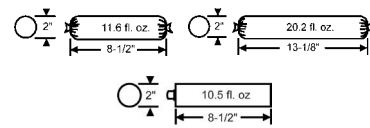

| Part Number | Description |
|-------------|-------------------------|
| 59-106 | 20oz Sausage Applicator |



20oz Sausage Gun with Dripless Function Switch eXcePt-600

- 19:1 Thrust ratio
- Integrated Tip Cutter
- Activated non-drip feature for drip-free operations
- Rust-resistant due to special alloy
- Rubberized handle and trigger
- Hardened thrust block (force >4000N)
- Rotatable half shell/ aluminum tube and ladder hook

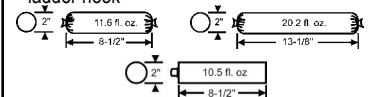

| Part Number | Description |
|-------------|-------------------------|
| 59-165 | 20oz Sausage Applicator |



10oz Caulking Gun FX7-90

- 17:1 Thrust ratio
- Professional push plate for total emptying
- Rust-resistant due to special alloy
- Rubberized handle and trigger
- Hardened thrust block (force >4000N)
- Rotatable half shell/ aluminum tube and ladder hook

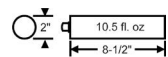

| Part Number | Description |
|-------------|--------------------------|
| 59-105 | 10oz Caulking Applicator |



10oz Caulking Gun with Drip Free Switch eXcePt-310

- 19:1 Thrust ratio
- Activated non-drip feature for drip-free operations
- Rust-resistant due to special alloy
- Rubberized handle and trigger
- Hardened thrust block (force >4000N)
- Rotatable half shell/ aluminum tube and ladder hook

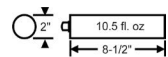

| Part Number | Description |
|-------------|--------------------------|
| 59-163 | 10oz Caulking Applicator |



10oz Caulking Gun with Drip Free Switch & Adjustable Thrust Ratio XP-DELTA

- Switchable thrust ratio
 - 25:1 Chemical anchoring, MS- Polymer etc.
 - 12:1 Silicone, Acrylic etc.
- Activated non-drip feature for drip-free operations
- Rust-resistant due to special alloy
- Rubberized handle and trigger
- Hardened thrust block (force >4000N)
- Rotary half shell and ladder hook

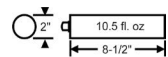

| Part Number | Description |
|-------------|--------------------------|
| 59-176 | 10oz Caulking Applicator |



Joint Finishing Set

- Made of elastic plastic
- For several different joint sizes
- For inclined or round joints
- Easy to handle
- Four pieces in a box

| Part Number | Description |
|-------------|------------------|
| 59-169 | Sealant Finisher |



| Part Number | Description |
|------------------------------|-----------------------|
| 59-179 | Joint Finisher Saddle |
| Used on 59-105 & 59-106 Guns | |

PHILADELPHIA YEADON MIAMI OWATONNA RENO

PHILADELPHIA: 2006 Elmwood Avenue • Sharon Hill, PA 19079 • 800-352-0800 • Sales Fax: 610-534-3202

MIAMI: 4181 West 108th Street, Suite 7 • Hialeah, FL 33018 • 800-780-5051 • Fax: 305-557-5239

STRYBUC.COM | CSERVICE@STRYBUC.COM

TERMS AND CONDITIONS

| | |
|---------------------------------------|--|
| TERMS | Net 30 days. |
| CREDIT | accepted |
| MINIMUM | \$25.00 Excluding shipping and handling. |
| PRICING | All pricing subject to change. SBI reserves the right to make price adjustments due to changing market conditions, product discontinuation, manufacturers price changes, and errors in advertisements. |
| ORDERING | Our catalog has been designed to make ordering as easy as possible. However, if you are not a 100% sure that you have found the part you need - PLEASE SEND A SAMPLE. To help expedite your orders, please use our part numbers and include your account number on all purchase orders. Customers must specify at time of order if back orders should be canceled. Otherwise back orders will be released routinely and not subject to return. |
| QUOTATIONS | All quotations good for 30 days, unless otherwise specified. If an item is not shown in our catalog, PLEASE SEND A SAMPLE with any available information. |
| FINISHING | Standard finishes will be provided. Please specify if you require a particular finish. |
| SUBSTITUTION | In order to satisfy need and provide our customers with the most economical and highest quality parts, we may replace catalog items with working substitutes from time to time. |
| CUSTOM MADE SPECIAL ORDER MERCHANDISE | In order to serve you better, we offer our machine shop facilities for items no longer available. A deposit may be required for custom made/special order material. We will not accept any returns or cancellations for custom made parts, therefore a written or faxed Purchase Order is required. |
| FREIGHT | No freight allowance. Shipping and handling charges are added to invoice. For "drop-ship" orders to residential buildings, higher shipping rates applied. |
| SHIPPING | Stock items - within 24 hours upon receipt of order. Non-stock items 3 to 8 weeks or as specified. FedEx® Delivery Service - Faster delivery options for all packages up to 20lbs. delivered within the Continental U.S.; (1) Economy Two Day SM Service. (2) Standard Overnight® Service for next day delivery. (3) Priority Overnight® Service delivered by 10:30 a.m. the next morning. Ask your Account Manager for current delivery costs. |
| DROP SHIP | SBI Express - Order Today, Install Tomorrow! A new program to "drop ship" directly to your customers using any of the above FedEx® Delivery Services |
| RETURNS | No material will be accepted without a Return Goods Authorization number (RGA# must appear outside of all cartons). Please call Account Manager for RGA#. A 25% Handling/Restocking charge will be assessed to all returns for reasons other than Strybuc errors. All returns must be made within 60 days of invoice date. Custom Made/Special Orders are not subject to return. |
| CLAIMS | It is your responsibility to inspect all shipments for shortages and damages (concealed or otherwise). If damage has occurred it is your responsibility to file a claim with the carrier, claims for shortages are to be filed with Strybuc Industries. All claims are to be made within 10 days. |
| DISCLAIMER | Photos and illustrations in this catalog are intended only to give an idea of what a product looks like. It is to identify that products use, and does not imply that the item is a genuine product of the said original manufacturer. |
| COPYRIGHT | © 2025 PGI. No part of this catalog may be reproduced without the express written consent of Strybuc Industries. |

Frameless Shower Door Hardware

TABLE TOP DISPLAY

Now available is our new Counter Display
(PART NUMBER: 500-358)

Our frameless shower door hardware includes a full line of standard duty and heavy duty hinges, glass clamps, door handles, knobs, towel bars, sealing strips, and a gliding shower door system.

Hardware comes in a square edge and bevel edge design in bright chrome and brushed nickel finishes.

Hinges and clamps are made of solid brass with stainless steel screws; handles made of stainless steel; with quality testing performed through-out the manufacturing process.

For more information, visit www.strybuc.com in our catalog section or call (800) 352.0800.

Free Display with \$1,000 Order!



| Part Number | Description |
|-------------|--------------------|
| 500-358 | Countertop Display |



THE ONE STOP SOURCE FOR ALL YOUR WINDOW & DOOR HARDWARE

Office Hours: 8:00 AM (EST) to 6:00 PM (EST)



Philadelphia, PA

1-800-352-0800
2006 Elmwood Avenue - 102C
Sharon Hill, PA 19079-1019

Yeadon, PA

Distribution Center

Miami, FL

1-800-780-5051
4181 West 108th Street, Suite 7
Hialeah, FL 33018

Reno, NV

Distribution Center

Owatonna, MN

Distribution Center

