

62 SERIES CHANNEL BALANCES

1/2" TILT WINDOW CHANNEL BALANCE

Actually 5/8" But Considered 1/2" in the Trade

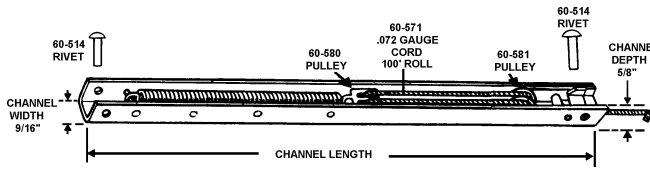

Ordering Information

- 1) Measure metal channel length (Do not include any attached ends.)
- 2) Check number stamped on channel: e.g., 2210, 22A, 2830 29C, etc.
- 3) Select our corresponding part number from the chart below.
- 4) Identify the appropriate end bracket to be attached from the illustrations shown, then add 1, 2, 3, or four to complete our part number.

Note: If your balance has a rivet in the first hole at the top, order separately as part number 60-514A.

General Information

- 1) Any other number/letter variations that may be stamped on your balance should first be discussed with your representative to insure that your order will be filled correctly.

Example Ordering Chart

Channel Length	Number Stamped	Part Number	End Bracket	Complete Part Number
21"	2010	62-201-	1	62-201-1
21"	2010	62-201-	2	62-201-2
21"	2010	62-201-	3	62-201-3
21"	2010	62-201-	4	62-201-4
21"	2010	62-201-	5	62-201-5

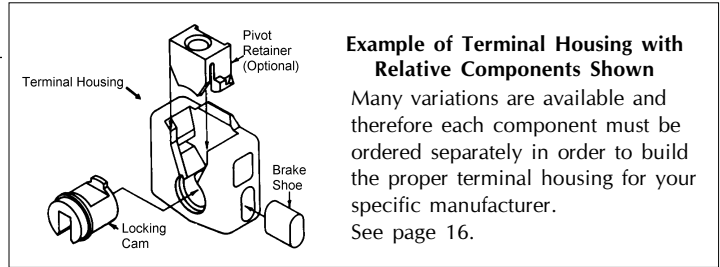

Example of Terminal Housing with Relative Components Shown

Many variations are available and therefore each component must be ordered separately in order to build the proper terminal housing for your specific manufacturer. See page 16.

End Brackets Add number to part.

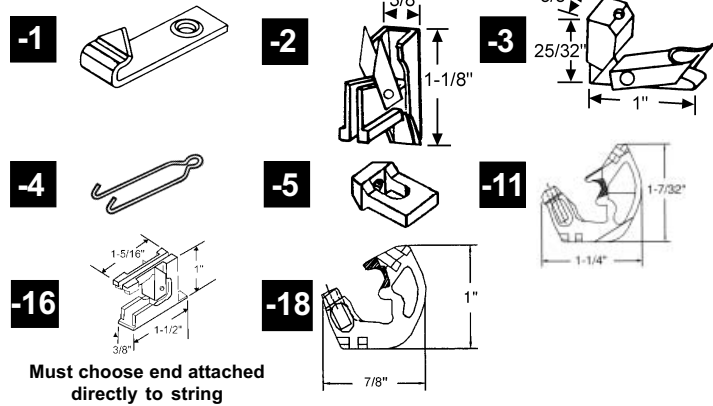

Length of Metal Channel	Number Stamped on Balance	Sash Weight (in lbs)	Our Part Number	Number Stamped on Balance	Sash Weight (in lbs)	Our Part Number	Number Stamped on Balance	Sash Weight (in lbs)	Our Part Number	Number Stamped on Balance	Sash Weight (in lbs.)	Our Part Number
10"	0910 or 9A		62-091-	0920 or 9B		62-092-	0930 or 9C		62-093-	0940 or 9D		62-094-
11"	1010 or 10A		62-101-	1020 or 10B		62-102-	1030 or 10C		62-103-	1040 or 10D		62-104-
12"	1110 or 11A		62-111-	1120 or 11B		62-112-	1130 or 11C		62-113-	1140 or 11D		62-114-
13"	1210 or 12A	3 to 8	62-121-	1220 or 12B	8 to 11	62-122-	1230 or 12C	11 to 13	62-123-	1240 or 12D	13 to 17	62-124-
14"	1310 or 13A	4 to 8	62-131-	1320 or 13B	8 to 11	62-132-	1330 or 13C	11 to 13	62-133-	1340 or 13D	13 to 17	62-134-
15"	1410 or 14A	4 to 7	62-141-	1420 or 14B	7 to 11	62-142-	1430 or 14C	11 to 14	62-143-	1440 or 14D	14 to 20	62-144-
16"	1510 or 15A	4 to 7	62-151-	1520 or 15B	7 to 11	62-152-	1530 or 15C	11 to 14	62-153-	1540 or 15D	14 to 20	62-154-
17"	1610 or 16A	4 to 8	62-161-	1620 or 16B	8 to 11	62-162-	1630 or 16C	11 to 14	62-163-	1640 or 16D	14 to 20	62-164-
18"	1710 or 17A	4 to 8	62-171-	1720 or 17B	8 to 11	62-172-	1730 or 17C	11 to 14	62-173-	1740 or 17D	14 to 20	62-174-
19"	1810 or 18A	4 to 8	62-181-	1820 or 18B	8 to 11	62-182-	1830 or 18C	11 to 14	62-183-	1840 or 18D	14 to 20	62-184-
20"	1910 or 19A	4 to 7	62-191-	1920 or 19B	7 to 11	62-192-	1930 or 19C	11 to 14	62-193-	1940 or 19D	14 to 20	62-194-
21"	2010 or 20A	4 to 8	62-201-	2020 or 20B	8 to 13	62-202-	2030 or 20C	13 to 17	62-203-	2040 or 20D	17 to 25	62-204-
22"	2110 or 21A	5 to 9	62-211-	2120 or 21B	9 to 13	62-212-	2130 or 21C	13 to 17	62-213-	2140 or 21D	17 to 25	62-214-
23"	2210 or 22A	5 to 9	62-221-	2220 or 22B	9 to 14	62-222-	2230 or 22C	14 to 18	62-223-	2240 or 22D	18 to 26	62-224-
24"	2310 or 23A	5 to 10	62-231-	2320 or 23B	10 to 16	62-232-	2330 or 23C	16 to 20	62-233-	2340 or 23D	20 to 27	62-234-
25"	2410 or 24A	5 to 10	62-241-	2420 or 24B	10 to 16	62-242-	2430 or 24C	16 to 20	62-243-	2440 or 24D	20 to 27	62-244-
26"	2510 or 25A	5 to 10	62-251-	2520 or 25B	10 to 15	62-252-	2530 or 25C	15 to 20	62-253-	2540 or 25D	20 to 27	62-254-
27"	2610 or 26A	5 to 10	62-261-	2620 or 26B	10 to 16	62-262-	2630 or 26C	16 to 20	62-263-	2640 or 26D	20 to 27	62-264-
28"	2710 or 27A	5 to 10	62-271-	2720 or 27B	10 to 16	62-272-	2730 or 27C	16 to 20	62-273-	2740 or 27D	20 to 27	62-274-
29"	2810 or 28A	7 to 13	62-281-	2820 or 28B	13 to 17	62-282-	2830 or 28C	17 to 24	62-283-	2840 or 28D	24 to 30	62-284-
30"	2910 or 29A	8 to 13	62-291-	2920 or 29B	13 to 17	62-292-	2930 or 29C	17 to 24	62-293-	2940 or 29D	24 to 30	62-294-
31"	3010 or 30A	8 to 13	62-301-	3020 or 30B	13 to 18	62-302-	3030 or 30C	18 to 24	62-303-	3040 or 30D	24 to 30	62-304-
32"	3110 or 31A	8 to 13	62-311-	3120 or 31B	13 to 17	62-312-	3130 or 31C	17 to 24	62-313-	3140 or 31D	24 to 30	62-314-
33"	3210 or 32A	8 to 14	62-321-	3220 or 32B	14 to 19	62-322-	3230 or 32C	19 to 24	62-323-	3240 or 32D	24 to 30	62-324-
34"	3310 or 33A	9 to 15	62-331-	3320 or 33B	15 to 19	62-332-	3330 or 33C	19 to 23	62-333-	3340 or 33D	23 to 30	62-334-
35"	3410 or 34A	9 to 15	62-341-	3420 or 34B	15 to 19	62-342-	3430 or 34C	19 to 25	62-343-	3440 or 34D	25 to 30	62-344-
36"	3510 or 35A	9 to 15	62-351-	3520 or 35B	15 to 19	62-352-	3530 or 35C	19 to 25	62-353-	3540 or 35D	25 to 30	62-354-
37"	3610 or 36A	9 to 15	62-361-	3620 or 36B	15 to 19	62-362-	3630 or 36C	19 to 25	62-363-	3640 or 36D	25 to 32	62-364-
38"	3710 or 37A	9 to 15	62-371-	3720 or 37B	15 to 19	62-372-	3730 or 37C	19 to 25	62-373-	3740 or 37D	25 to 32	62-374-
39"	3810 or 38A	9 to 15	62-381-	3820 or 38B	15 to 20	62-382-	3830 or 38C	20 to 25	62-383-	3840 or 38D	25 to 32	62-384-
40"	3910 or 39A	9 to 15	62-391-	3920 or 39B	15 to 20	62-392-	3930 or 39C	20 to 25	62-393-	3940 or 39D	25 to 32	62-394-
41"	4010 or 40A	9 to 15	62-401-	4020 or 40B	15 to 20	62-402-	4030 or 40C	20 to 25	62-403-	4040 or 40D	25 to 32	62-404-
42"	4110 or 41A	9 to 16	62-411-	4120 or 41B	16 to 20	62-412-	4130 or 41C	20 to 25	62-413-	4140 or 41D	25 to 32	62-414-
43"	4210 or 42A	9 to 16	62-421-	4220 or 42B	16 to 20	62-422-	4230 or 42C	20 to 26	62-423-	4240 or 42D	26 to 32	62-424-
44"	4310 or 43A	9 to 15	62-431-	4320 or 43B	15 to 20	62-432-	4330 or 43C	20 to 26	62-433-	4340 or 43D	26 to 32	62-434-
45"	4410 or 44A	9 to 15	62-441-	4420 or 44B	15 to 20	62-442-	4430 or 44C	20 to 26	62-443-	4440 or 44D	26 to 32	62-444-

62 SERIES BALANCE ACCESSORIES

BALANCE TERMINAL

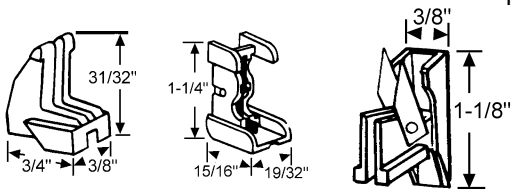

Used with Wire Clip 62-504

62-500

62-501

62-502 White
62-511 Black

LOCKING TERMINALS

Plastic with Metal Lock

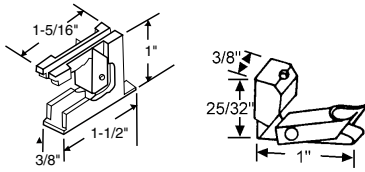

62-682 White

62-682B Black

62-682BE Blue

62-682BR Brown

62-503

WIRE CLIP

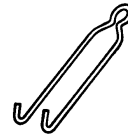

62-504

BALANCE CLIP

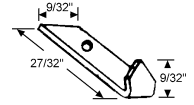

60-518

TERMINAL HOUSINGS

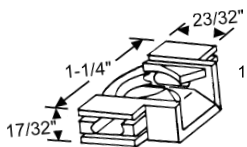

62-508

9/16" Dia. Hole

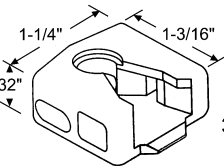

62-512

9/16" Dia. Hole

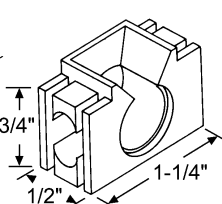

62-505

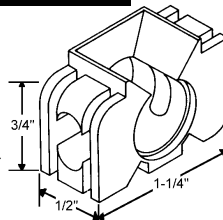

62-506

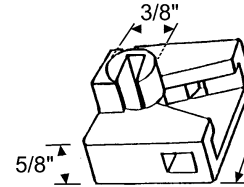

62-534

Right Hand

Use with 5/8" Cam

Graham

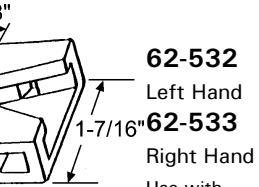

62-532

Left Hand

62-533

Right Hand

Use with 15/16" Cam

TERMINAL HOUSING

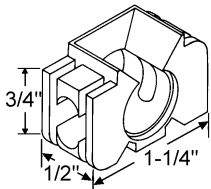

62-507

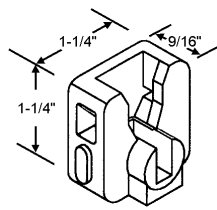

900-9312A

Locking terminal

Graham

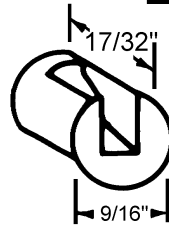

62-509

LOCKING CAMS

Die Cast

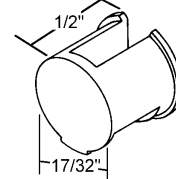

62-513

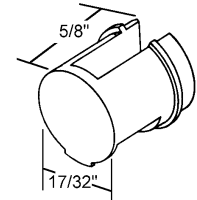

62-514

LOCKING CAMS

Die Cast

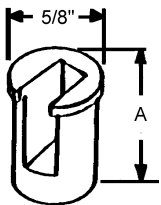

900-9447

15/16"

900-9447M

5/8"

Graham

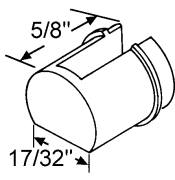

62-516

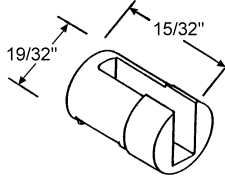

900-18394

Use 900-9447

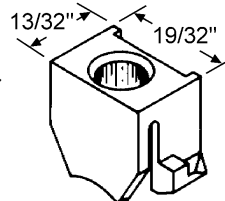

62-519

BRAKE SHOES

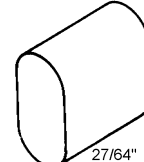

62-510 White

62-614 Black

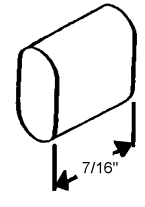

900-9310

Graham

TILT STUDS

Die Cast

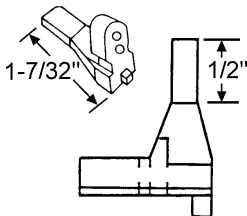

62-603 Left

62-604 Right

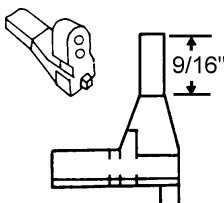

62-612 Left

62-611 Right

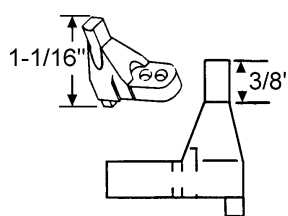

62-616 Left

62-617 Right

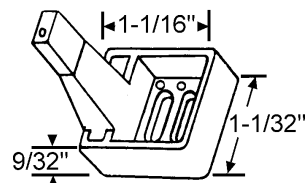

62-620

62-621

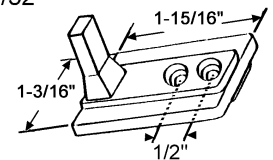

900-9443B

Brass

The above parts have right/left marked on part.

62 SERIES BALANCE ACCESSORIES

METAL TILT STUDS

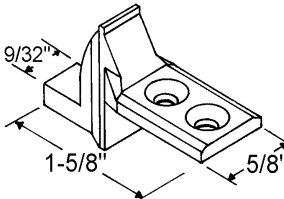

62-656
Caradco

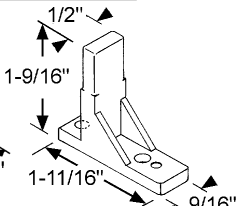

900-13354
SWS

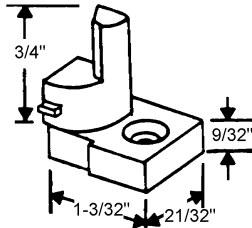

62-608 Right Opposite
62-609 Left Shown
Custom Made

PLASTIC TILT STUDS

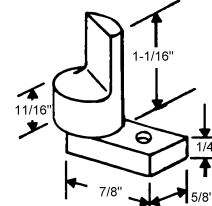

62-622A Set
Repco

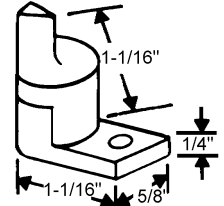

62-625 Left Opposite
62-626 Right Shown

PLASTIC TILT STUDS

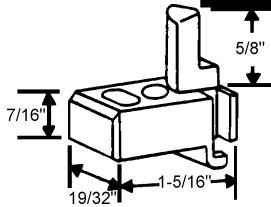

62-600 Left Shown
62-601 Right Opposite

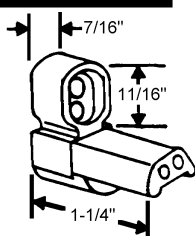

62-602

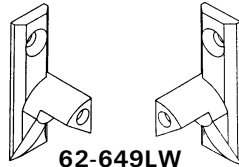

62-649LW
LH Natural
62-649RB
RH Black
62-650RH/LH
Black Zinc

BUSHINGS



62-613

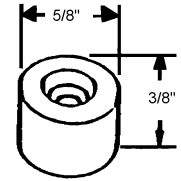

62-658

PIVOT BARS

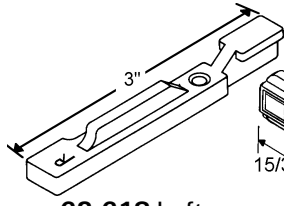

62-618 Left
62-619 Right

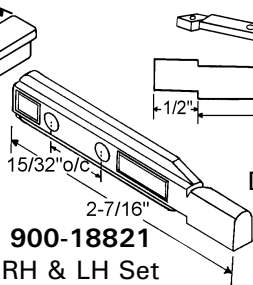

900-18821
RH & LH Set

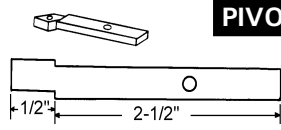

62-624
Die Cast

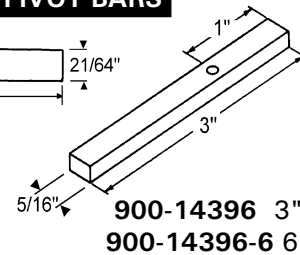

900-14396 3"
900-14396-6 6"

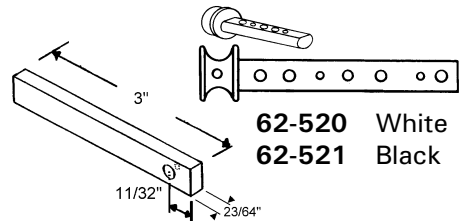

62-520 White
62-521 Black

SASH RETAINERS

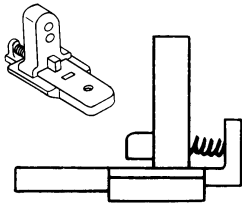

62-605 White
62-615 Black

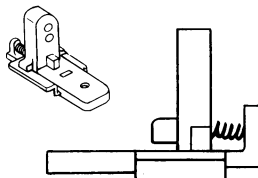

62-610
Black

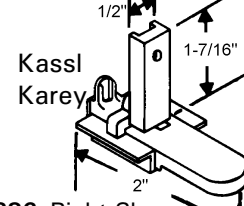

62-636 Right Shown
62-637 Left Opposite

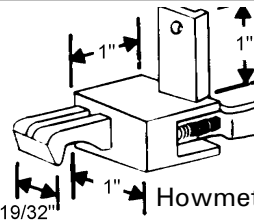

62-606 Right Opposite
62-607 Left Shown

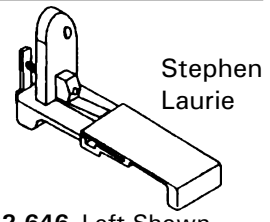

62-646 Left Shown
62-647 Right Opposite
Clear Plastic

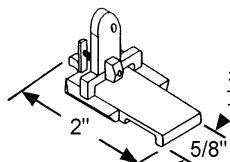

62-644 Left
62-645 Right
Clear Plastic

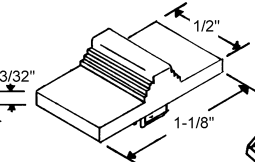

62-643 White
62-643B Black

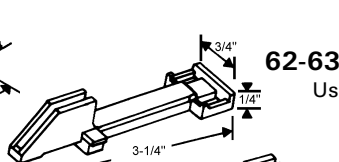

62-633
Lower

62-634 Upper Nylon
Use 85-506

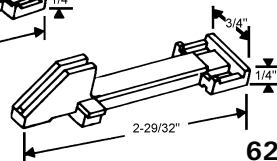

62-629

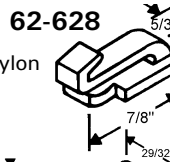

62-628

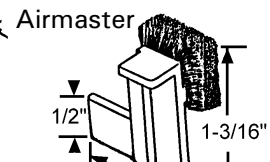

62-641 Left Opposite
62-642 Right Shown

SHORT "S" CLIP

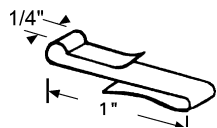

62-517

LONG "S" CLIP

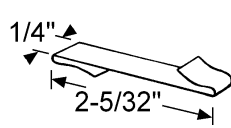

62-518

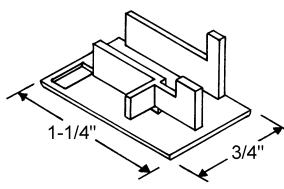

62-661 Shown
62-662 Opposite

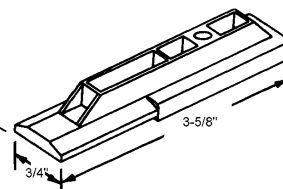

900-11376
Graham



900-11377
Graham

62A SERIES BALANCES FOR JAMBLINERS

1/2" RIBBED CHANNEL BALANCE FOR JAMBLINERS COMMONLY REFERED TO AS D70 BALANCES

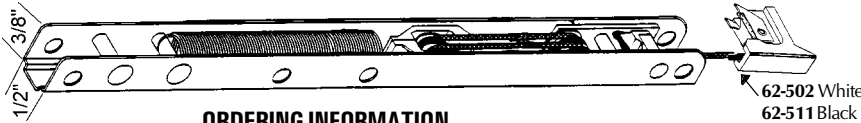

ORDERING INFORMATION

- 1) Measure metal channel length. Do not include any attached ends.
- 2) Check number stamped on channel e.g. 16, 16HD, 16TG etc.
- 3) Select our corresponding part number from the chart below.
- 4) Identify the appropriate end bracket to be attached from illustration at right of chart. Select -2, -7, -8, -9, -12, -14, -17.
- 5) Note -2, -8, -12, are available in white & black. White will automatically be attached to regular balances; black will automatically be attached to HD, TG & XHD balances.

GENERAL INFORMATION

- 1) In order to remove D70 balances you must first remove all window trim and remove sash along with Jambliners. Forcing balances out of Jambliner pocket will most likely destroy vinyl extrusion! Balances can then be slid out of jambliner sleeve once parts are moved to the release position.
- 2) Balances can be special ordered in beige or white finishes
Contact your Account Manager for part numbers.

LENGTH OF METAL CHANNEL	NUMBER STAMPED ON BALANCE	OUR PART NUMBER	29" LENGTH OF METAL CHANNEL	28TG or 28XHD NUMBER STAMPED ON BALANCE	62A-28TG-OUR PART NUMBER
13"	12 or 12R	62A-12-	30"	29 or 29R	62A-29-
13"	12HD	62A-12HD-	30"	29HD	62A-29HD-
14"	13 or 13R	62A-13-	30"	29TG or 29XHD	62A-29TG-
14"	13HD	62A-13HD-	31"	30 or 30R	62A-30-
15"	14 or 14R	62A-14-	31"	30HD	62A-30HD-
15"	14HD	62A-14HD-	31"	30TG or 30XHD	62A-30TG-
16"	15 or 15R	62A-15-	32"	31 or 31R	62A-31-
16"	15HD	62A-15HD-	32"	31HD	62A-31HD-
17"	16 or 16R	62A-16-	32"	31TG or 31XHD	62A-31TG-
17"	16HD	62A-16HD-	33"	32 or 32R	62A-32-
18"	17 or 17R	62A-17-	33"	32HD	62A-32HD-
18"	17HD	62A-17HD-	33"	32TG or 32XHD	62A-32TG-
19"	18 or 18R	62A-18-	34"	33 or 33R	62A-33-
19"	18 HD	62A-18HD-	34"	33HD	62A-33HD-
20"	19 or 19R	62A-19-	34"	33TG or 33XHD	62A-33TG-
20"	19HD	62A-19HD-	35"	34 or 34R	62A-34-
21"	20 or 20R	62A-20-	35"	34HD	62A-34HD-
21"	20HD	62A-20HD-	35"	34TG or 34XHD	62A-34TG-
21"	20TG or 20XHD	62A-20TG-	36"	35 or 35R	62A-35-
22"	21 or 21R	62A-21-	36"	35HD	62A-35HD-
22"	21HD	62A-21HD-	36"	35TG or 35XHD	62A-35TG-
22"	21TG or 21XHD	62A-21TG-	37"	36 or 36R	62A-36-
23"	22 OR 22R	62A-22-	37"	36HD	62A-36HD-
23"	22HD	62A-22HD-	37"	36TG or 36XHD	62A-36TG-
23"	22TG or 22XHD	62A-22TG-	38"	37 or 37R	62A-37-
24"	23 or 23R	62A-23-	38"	37HD	62A-37HD-
24"	23HD	62A-23HD-	38"	37TG or 37XHD	62A-37TG-
24"	23TG or 23XHD	62A-23TG-	39"	38 or 38R	62A-38-
25"	24 or 24R	62A-24-	39"	38HD	62A-38HD-
25"	24HD	62A-24HD-	39"	38TG or 38XHD	62A-38TG-
25"	24TG or 24XHD	62A-24TG-	40"	39 or 39R	62A-39-
26"	25 or 25R	62A-25-	40"	39HD	62A-39HD-
26"	25HD	62A-25HD-	40"	39TG or 39XHD	62A-39TG-
26"	25TG or 25XHD	62A-25TG-	41"	40 or 40R	62A-40-
27"	26 or 26R	62A-26-	41"	40HD	62A-40HD-
27"	26HD	62A-26HD-	41"	40TG or 40XHD	62A-40TG-
27"	26TG or 26XHD	62A-26TG-	42"	41 or 41R	62A-41-
28"	27 or 27R	62A-27-	42"	41HD	62A-41HD-
28"	27HD	62A-27HD-	42"	41TG or 41XHD	62A-41TG-
28"	27TG or 27XHD	62A-27TG-	43"	42 or 42R	62A-42-
29"	28 or 28R	62A-28-	43"	42HD	62A-42HD-
29"	28HD	62A-28HD-	43"	42TG or 42XHD	62A-42TG-

62A SERIES BALANCE ACCESSORIES

Cam Pivots

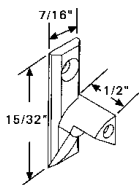

62-649RB Black
62-650RH Zinc
Right Hand

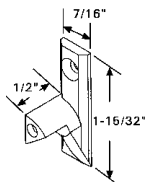

62-649LW White
62-650LH Zinc
Left Hand

62-526
Attached
separately

End Brackets

Add number to part.

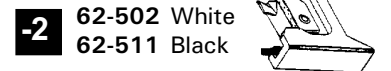

-2 **62-502** White
62-511 Black

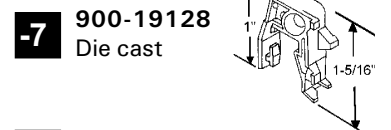

-7 **900-19128**
Die cast

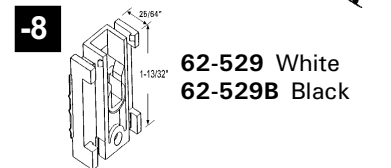

-8 **62-529** White
62-529B Black

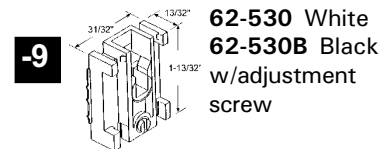

-9 **62-530** White
62-530B Black
w/adjustment
screw

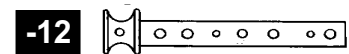

-12 **62-520** White
62-521 Black

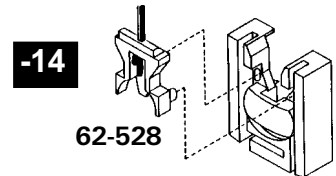

-14 **62-528**

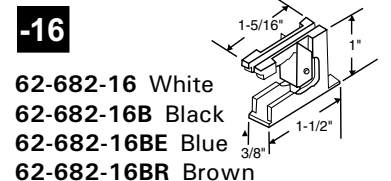

-16 **62-682-16** White
62-682-16B Black
62-682-16BE Blue
62-682-16BR Brown

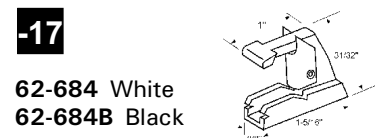

-17 **62-684** White
62-684B Black

62A SERIES BALANCE ACCESSORIES

Tie-Bar

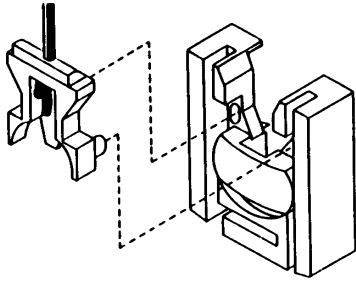

62-528

Locking Terminal

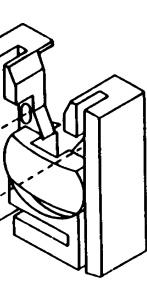

62-526
Attached
separately

Locking Terminal

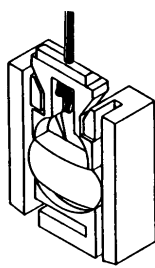

62-527
Non Take-Out

Locking Terminals

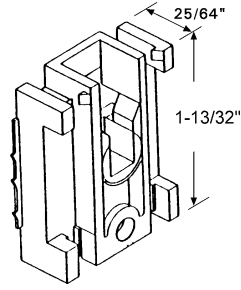

62-529
White
62-529B
Black

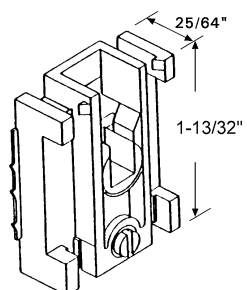

62-530 White
62-530B Black
w/adjustment screw

Cam Pivots

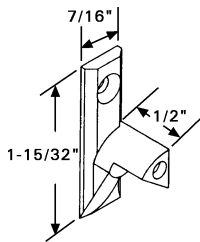

62-649RB Black
62-650RH Zinc
Plastic Right Hand

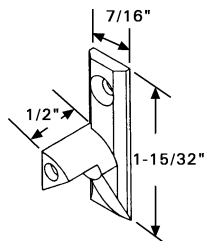

62-649LW White
62-650LH Zinc
Plastic Left Hand

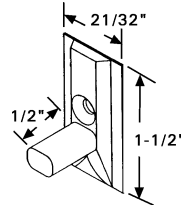

62-652

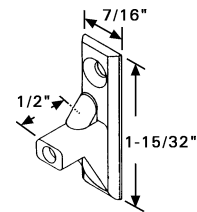

62-653

Cam Pivots

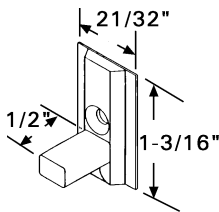

62-654

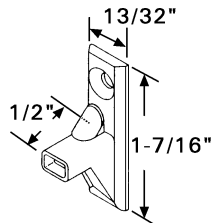

62-655

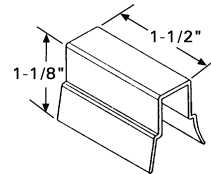

62-701BG Beige
62-701 White

S-Clips

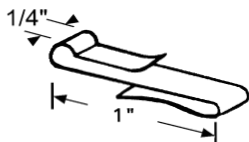

62-517
Short

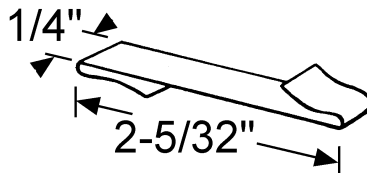

62-518
Long

Installation Brackets

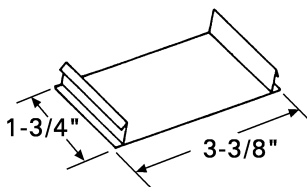

86-21
Vinyl Release

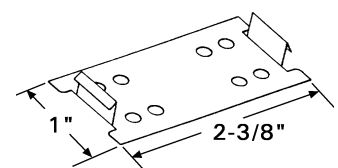

86-22
Standard

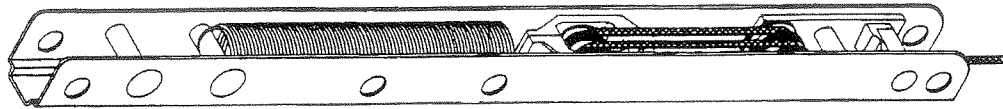

ORDERING INFORMATION

- 1) Measure metal channel length. Do not include any attached ends.
- 2) Check number stamped on channel e.g. 16, 16HD, 16TG etc.
- 3) Select our corresponding part number from the chart below.
- 4) Identify the appropriate locking terminal to be attached from illustrations shown and order accordingly.

GENERAL INFORMATION

- 1) All 62C series balances will be supplied with either 62-529, 62-529B or 62-530 Locking Terminal attached.
 - 2) If ordering the 62-529 attached, please add -8 after our part number.
- If ordering the 62-529B attached, please add -9 after our part number. If ordering the 62-530 attached, please add 3 after our part number.

Example Ordering Chart			
Balance Length	Number Stamped	End Attached	Complete Part Number
23"	22TG	-8	62C-22TG-8
35"	34 or 34R	-9	62C-34-9

LENGTH OF METAL CHANNEL	NUMBER STAMPED ON BALANCE	OUR PART NUMBER	LENGTH OF METAL CHANNEL	NUMBER STAMPED ON BALANCE	OUR PART NUMBER
13"	12 or 12R	62C-12-__	30"	29 or 29R	62C-29-__
13"	12HD	62C-12HD-__	30"	29HD	62C-29HD-__
14"	13 or 13R	62C-13-__	30"	29TG or 29XHD	62C-29TG-__
14"	13HD	62C-13HD-__	31"	30 or 30R	62C-30-__
15"	14 or 14R	62C-14-__	31"	30HD	62C-30HD-__
15"	14HD	62C-14HD-__	31"	30TG or 30XHD	62C-30TG-__
16"	15 or 15R	62C-15-__	32"	31 or 31R	62C-31-__
16"	15HD	62C-15HD-__	32"	31HD	62C-31HD-__
17"	16 or 16R	62C-16-__	32"	31TG or 31XHD	62C-31TG-__
17"	16HD	62C-16HD-__	33"	32 or 32R	62C-32-__
18"	17 or 17R	62C-17-__	33"	32HD	62C-32HD-__
18"	17HD	62C-17HD-__	33"	32TG or 32XHD	62C-32TG-__
19"	18 or 18R	62C-18-__	34"	33 or 33R	62C-33-__
19"	18 HD	62C-18HD-__	34"	33HD	62C-33HD-__
20"	19 or 19R	62C-19-__	34"	33TG or 33XHD	62C-33TG-__
20"	19HD	62C-19HD-__	35"	34 or 34R	62C-34-__
21"	20 or 20R	62C-20-__	35"	34HD	62C-34HD-__
21"	20HD	62C-20HD-__	35"	34TG or 34XHD	62C-34TG-__
21"	20TG or 20XHD	62C-20TG-__	36"	35 or 35R	62C-35-__
22"	21 or 21R	62C-21-__	36"	35HD	62C-35HD-__
22"	21HD	62C-21HD-__	36"	35TG or 35XHD	62C-35TG-__
22"	21TG or 21XHD	62C-21TG-__	37"	36 or 36R	62C-36-__
23"	22 OR 22R	62C-22-__	37"	36HD	62C-36HD-__
23"	22HD	62C-22HD-__	37"	36TG or 36XHD	62C-36TG-__
23"	22TG or 22XHD	62C-22TG-__	38"	37 or 37R	62C-37-__
24"	23 or 23R	62C-23-__	38"	37HD	62C-37HD-__
24"	23HD	62C-23HD-__	38"	37TG or 37XHD	62C-37TG-__
24"	23TG or 23XHD	62C-23TG-__	39"	38 or 38R	62C-38-__
25"	24 or 24R	62C-24-__	39"	38HD	62C-38HD-__
25"	24HD	62C-24HD-__	39"	38TG or 38XHD	62C-38TG-__
25"	24TG or 24XHD	62C-24TG-__	40"	39 or 39R	62C-39-__
26"	25 or 25R	62C-25-__	40"	39HD	62C-39HD-__
26"	25HD	62C-25HD-__	40"	39TG or 39XHD	62C-39TG-__
26"	25TG or 25XHD	62C-25TG-__	41"	40 or 40R	62C-40-__
27"	26 or 26R	62C-26-__	41"	40HD	62C-40HD-__
27"	26HD	62C-26HD-__	41"	40TG or 40XHD	62C-40TG-__
27"	26TG or 26XHD	62C-26TG-__	42"	41 or 41R	62C-41-__
28"	27 or 27R	62C-27-__	42"	41HD	62C-41HD-__
28"	27HD	62C-27HD-__	42"	41TG or 41XHD	62C-41TG-__
28"	27TG or 27XHD	62C-27TG-__	43"	42 or 42R	62C-42-__
29"	28 or 28R	62C-28-__	43"	42HD	62C-42HD-__
29"	28HD	62C-28HD-__	43"	42TG or 42XHD	62C-42TG-__
29"	28TG or 28XHD	62C-28TG-__			

Balances Stamped With Additional Numbers May Indicate Special Sash Weights.
Please Consult Your Account Manager.

Locking Terminals

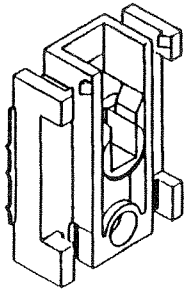

62-529 White
62-529B Black

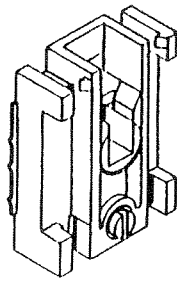

62-530 White
with Adjustment Screw

S-Clips

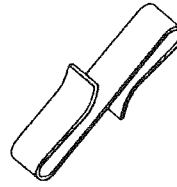

62-517
Short

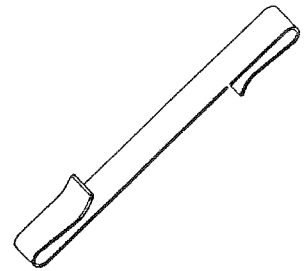

62-518
Long

Sash Stop

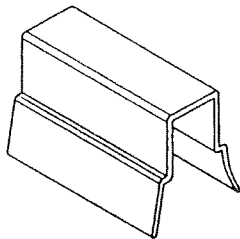

62-701BG Beige
62-701 White

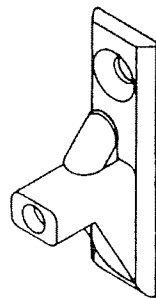

62-653

Cam Pivots

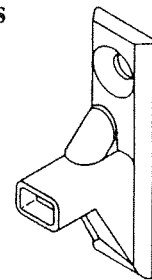

62-655

Installation Brackets

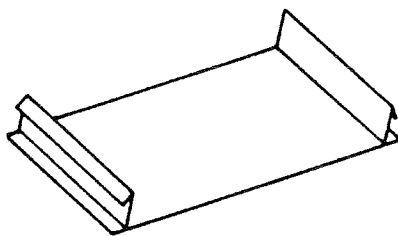

86-21
Vinyl Release

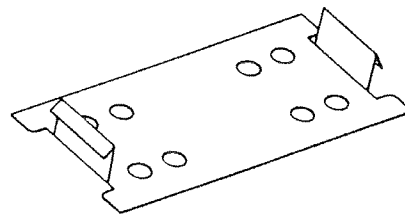

86-22
Standard

62DV SERIES DEVAC OVERHEAD CHANNEL BALANCES

Single Spring Channel - Aluminum 9/16" wide x 5/8" deep

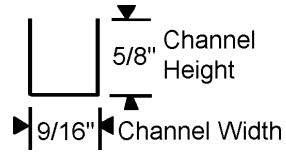

Double Spring Channel - Steel 9/16" wide x 13/16" deep

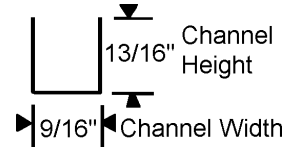
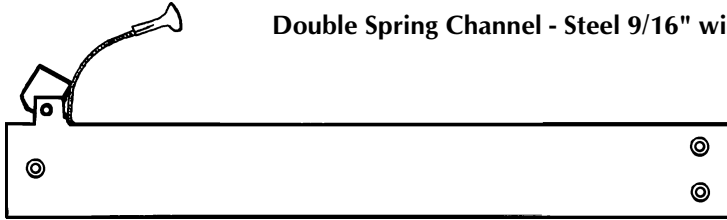

ORDERING INFORMATION

- 1) Measure metal channel length.
- 2) Check number old or new number stamped on balance e.g. 111 or 1210
- 3) Select our corresponding part number from the chart below and order accordingly.

GENERAL INFORMATION

- 1) All balances now use Dacron cord. Stainless steel cable with copper hook terminal are no longer being produced.
- 2) It is important to note how much cord extends from your balance to the window sill (in inches) in order to insure the proper amount of cord travel. Our chart will indicate standard lengths but if additional inches of cord are required, add a plus (+) sign after the part number and indicate the number of extra inches of cord required.
- 3) When the letter "D" alone is stamped on your balance, it denotes a double spring. HD on the other hand simply denotes heavy duty.

Old Balance Number	Old Balance Length	New Balance Number	New Balance Length	Standard Cord Length in Balance	Sash Weight Per Pair	Our Part #
111	12-3/4"	1210 HD	13"	31"	4-7 lbs.	62DV-1210HD
112	12-3/4"	1220 HD	13"	31"	7-11 lbs	62DV-1220HD
112-D	13-1/4"	112 D	13-1/4"	36"	11-18 lbs.	62DV-112D
121	15-1/4"	1510 HD	16"	37"	5-9 lbs.	62DV-1510HD
122	15-1/4"	1520 HD	16"	37"	9-13 lbs.	62DV-1520HD
122-D	16-1/4"	122-D	16-1/4"	42"	12-22 lbs.	62DV-122D
151	19-1/4"	1910 HD	20"	41"	5-11 lbs.	62DV-1910HD
152	19-1/4"	1920 HD	20"	41"	8-14 lbs.	62DV-1920HD
153	19-1/4"	1930 HD	20"	41"	14-18 lbs.	62DV-1930HD
153-D	19-3/4"	153-D	19-3/4"	47"	16-28 lbs.	62DV-153D
162	23-1/4"	2320 HD	24"	47"	9-14 lbs.	62DV-2320HD
163	23-1/4"	2330 HD	24"	47"	12-20 lbs.	62DV-2330HD
163-D	23-3/4"	163-D	23-3/4"	53"	20-32 lbs.	62DV-163D
183	27-1/4"	2730 HD	28"	50"	16-25 lbs.	62DV-2730HD
183-D	28-1/4"	183-D	28-1/4"	58"	22-34 lbs.	62DV-183D

62DV SERIES BALANCE ACCESSORIES

Devac Sash Stops

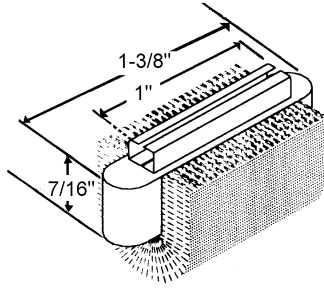
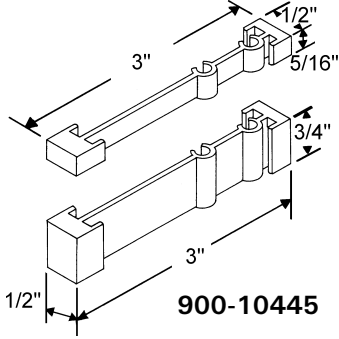

Pin Lock Spring

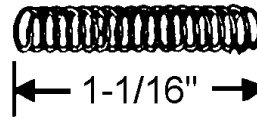

Sash Retainer

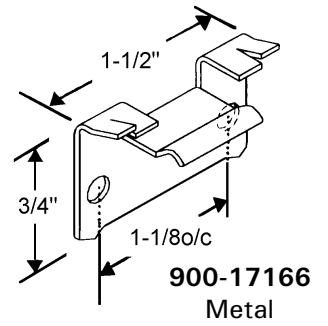

Short Locking Pin

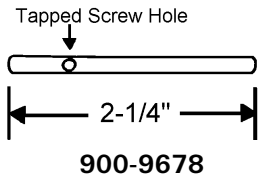

Long Locking Pin

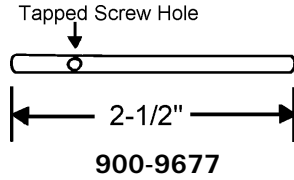

Cushion Block Spring

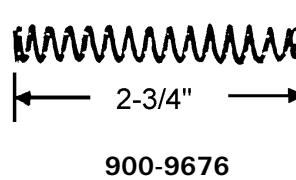

Red Nylon Cushion Block

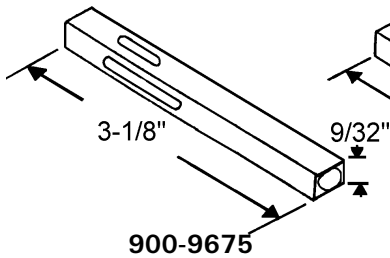

Red Nylon Balance Cushion

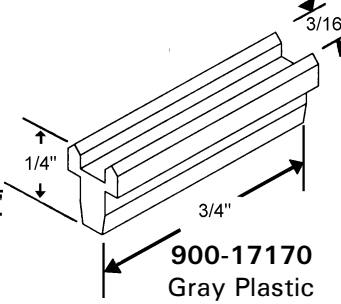
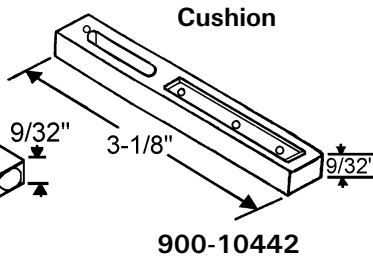

Latch Assembly Housing

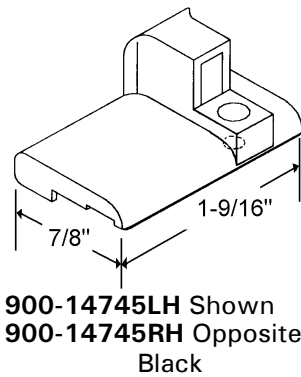
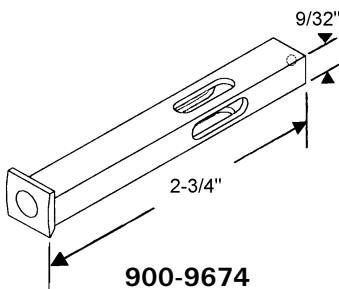

Pin Lock Handles

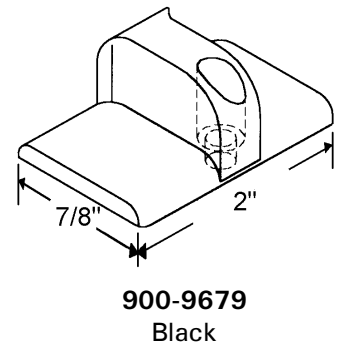
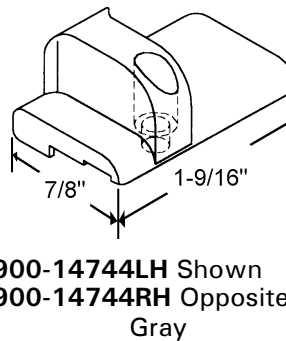

Old Style Sash Clips

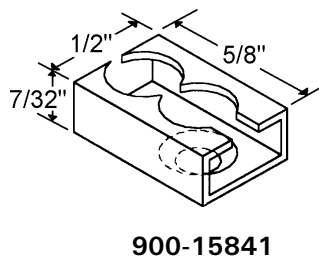
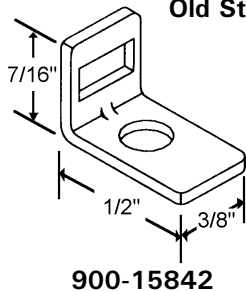

Old Style Balance Clip

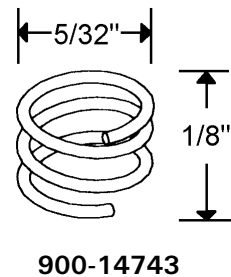
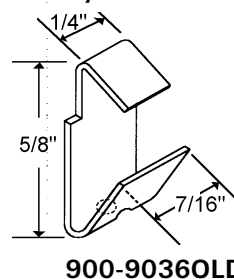

1/2" x 1/2" TILT CHANNEL BALANCE - 62F SERIES

SASH SUPPORT SYSTEMS

If ordering with our 60-518 attached, add "-1" after part number

Please Note Height

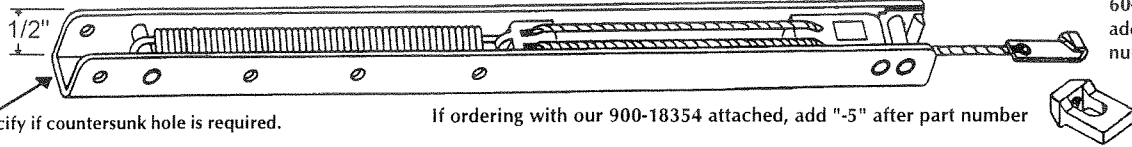

Please specify if countersunk hole is required.

If ordering with our 900-18354 attached, add "-5" after part number

Ordering Information

- 1) Measure metal channel length (Do not include any attached ends.)
- 2) Check number stamped on channel: e.g., 2130, 2510, etc.
- 3) Select our corresponding part number from the chart below.
- 4) Identify the appropriate balance end to be attached add the appropriate -1 (60-518) or -5 (900-18354) after the part number and order accordingly.
- 5) If the letter "T" appears after the number stamped, it indicates a **Top Sash Balance**; when ordering add the letter "T" at the end of our part number.

General Information

- 1) Please note that the 1/2" channel height is smaller than the usual 19/32" height on standard balances.
- 2) If metal channel length does not correspond with the number stamped on balance, consult your representative since your balance may be a special order

Channel Length	Number Stamped	Part Number	End Attached	Complete Part Number
21"	2050	62F-205-	-1	62F-205-1
24"	2350	62F-235	-5	62F-235-5

LENGTH OF METAL CHANNEL	NUMBER STAMPED ON BALANCE	FOR SASH WEIGHING	OUR PART NUMBER	LENGTH OF METAL CHANNEL	NUMBER STAMPED ON BALANCE	FOR SASH WEIGHING	OUR PART NUMBER
11"	1010	3-7 lbs.	62F-101-	18"	1740	13-19 lbs.	62F-174-
11"	1020	7-10 lbs.	62F-102-	19"	1810	4-7 lbs.	62F-181-
11"	1040	10-12 lbs.	62F-104-	19"	1820	7-10 lbs.	62F-182-
12"	1110	3-7 lbs.	62F-111-	19"	1830	10-13 lbs.	62F-183-
12"	1120	7-10 lbs.	62F-112-	19"	1840	13-19 lbs.	62F-184-
12"	1140	10-12 lbs.	62F-114-	20"	1910	4-6 lbs.	62F-191-
13"	1210	3-7 lbs.	62F-121-	20"	1920	6-10 lbs.	62F-192-
13"	1220	7-10 lbs.	62F-122-	20"	1930	10-13 lbs.	62F-193-
13"	1230	10-12 lbs.	62F-123-	20"	1940	13-19 lbs.	62F-194-
13"	1240	12-16 lbs.	62F-124-	21"	2010	4-7 lbs.	62F-201-
14"	1310	4-7 lbs.	62F-131-	21"	2020	7-12 lbs.	62F-202-
14"	1320	7-10 lbs.	62F-132-	21"	2030	12-15 lbs.	62F-203-
14"	1330	10-12 lbs.	62F-133-	21"	2040	15-23 lbs.	62F-204-
14"	1340	12-16 lbs.	62F-134-	21"	2050	23-26 lbs.	62F-205-
15"	1410	4-6 lbs.	62F-141-	22"	2110	5-8 lbs.	62F-211-
15"	1420	6-10 lbs.	62F-142-	22"	2120	8-12 lbs.	62F-212-
15"	1430	10-13 lbs.	62F-143-	22"	2130	12-15 lbs.	62F-213-
15"	1440	13-19 lbs.	62F-144-	22"	2140	15-23 lbs.	62F-214-
16"	1510	4-6 lbs.	62F-151-	22"	2150	23-26 lbs.	62F-215-
16"	1520	6-10 lbs.	62F-152-	23"	2210	5-8 lbs.	62F-221-
16"	1530	10-13 lbs.	62F-153-	23"	2220	8-13 lbs.	62F-222-
16"	1540	13-19 lbs.	62F-154-	23"	2230	13-16 lbs.	62F-223-
17"	1610	4-7 lbs.	62F-161-	23"	2240	16-24 lbs.	62F-224-
17"	1620	7-10 lbs.	62F-162-	23"	2250	27-29 lbs.	62F-225-
17"	1630	10-13 lbs.	62F-163-	24"	2310	5-9 lbs.	62F-231-
17"	1640	13-19 lbs.	62F-164-	24"	2320	9-15 lbs.	62F-232-
18"	1710	4-7 lbs.	62F-171-	24"	2330	15-18 lbs.	62F-233-
18"	1720	7-10 lbs.	62F-172-	24"	2340	18-25 lbs.	62F-234-
18"	1730	10-13 lbs.	62F-173-	24"	2350	28-30 lbs.	62F-235-

Chart Continued Next Page

Chart Continued

LENGTH OF METAL CHANNEL	NUMBER STAMPED ON BALANCE	FOR SASH WEIGHING	OUR PART NUMBER	LENGTH OF METAL CHANNEL	NUMBER STAMPED ON BALANCE	FOR SASH WEIGHING	OUR PART NUMBER
25"	2410	5-9 lbs.	62F-241-	33"	3210	8-13 lbs.	62F-321-
25"	2420	9-15 lbs.	62F-242-	33"	3220	13-18lbs.	62F-322-
25"	2430	15-18 lbs.	62F-243-	33"	3230	18-22 lbs.	62F-323-
25"	2440	18-25 lbs.	62F-244-	33"	3240	22-28 lbs.	62F-324-
25"	2450	28-30 lbs.	62F-245-	33"	3250	34-35 lbs.	62F-325-
26"	2510	5-9 lbs.	62F-251-	34"	3310	9-14 lbs.	62F-331-
26"	2520	9-14 lbs.	62F-252-	34"	3320	14-18 lbs.	62F-332-
26"	2530	14-18 lbs.	62F-253-	34"	3330	18-22 lbs.	62F-333-
26"	2540	18-25 lbs.	62F-254-	34"	3340	22-28 lbs.	62F-334-
26"	2550	28-30 lbs.	62F-255-	34"	3350	34-35 lbs.	62F-335-
27"	2610	5-9 lbs.	62F-261-	35"	3410	9-14 lbs.	62F-341-
27"	2620	9-15 lbs.	62F-262-	35"	3420	14-18 lbs.	62F-342-
27"	2630	15-18 lbs.	62F-263-	35"	3430	18-23 lbs.	62F-343-
27"	2640	18-25 lbs.	62F-264-	35"	3440	23-29 lbs.	62F-344-
27"	2650	28-30 lbs.	62F-265-	35"	3450	34-35 lbs.	62F-345-
28"	2710	5-9 lbs.	62F-271-	36"	3510	9-14 lbs.	62F-351-
28"	2720	9-15 lbs.	62F-272-	36"	3520	14-18 lbs.	62F-352-
28"	2730	15-18 lbs.	62F-273-	36"	3530	18-23 lbs.	62F-353-
28"	2740	18-25 lbs.	62F-274-	36"	3540	23-29 lbs.	62F-354-
28"	2750	28-30 lbs.	62F-275-	36"	3550	34-35 lbs.	62F-355-
29"	2810	7-12 lbs.	62F-281-	37"	3610	9-14 lbs.	62F-361-
29"	2820	12-15 lbs.	62F-282-	37"	3620	14-17 lbs.	62F-362-
29"	2830	15-22 lbs.	62F-283-	37"	3630	17-23 lbs.	62F-363-
29"	2840	22-28 lbs.	62F-284-	37"	3640	23-30 lbs.	62F-364-
29"	2850	31-33 lbs.	62F-285-	37"	3650	34-35 lbs.	62F-365-
30"	2910	8-12 lbs.	62F-291-	38"	3710	9-14 lbs.	62F-371-
30"	2920	12-15 lbs.	62F-292-	38"	3720	14-17 lbs.	62F-372-
30"	2930	15-22 lbs.	62F-293-	38"	3730	17-23 lbs.	62F-373-
30"	2940	22-28 lbs.	62F-294-	38"	3740	23-30 lbs.	62F-374-
30"	2950	31-33 lbs.	62F-295-	38"	3750	34-35 lbs.	62F-375-
31"	3010	8-12 lbs.	62F-301-	39"	3810	9-14 lbs.	62F-381-
31"	3020	12-16 lbs.	62F-302-	39"	3820	14-19 lbs.	62F-382-
31"	3030	16-22 lbs.	62F-303-	39"	3830	19-23 lbs.	62F-383-
31"	3040	22-28 lbs.	62F-304-	39"	3840	23-30 lbs.	62F-384-
31"	3050	31-33 lbs.	62F-305-	39"	3850	34-35 lbs.	62F-385-
32"	3110	8-12 lbs.	62F-311-	40"	3910	9-14 lbs.	62F-391-
32"	3120	12-15 lbs.	62F-312-	40"	3920	14-19 lbs.	62F-392-
32"	3130	15-22 lbs.	62F-313-	40"	3930	19-23 lbs.	62F-393-
32"	3140	22-28 lbs.	62F-314-	40"	3940	23-30 lbs.	62F-394-
32"	3150	31-33 lbs.	62F-315-	40"	3950	34-35 lbs.	62F-395-

For Balances Larger than Sizes Shown, Please Call Your Representative

Balances Stamped With Additional Numbers May Indicate Special Sash Weights.

Please Consult Your Account Manager.

62FC SERIES 1/2" X 1/2" TILT CHANNEL BALANCE

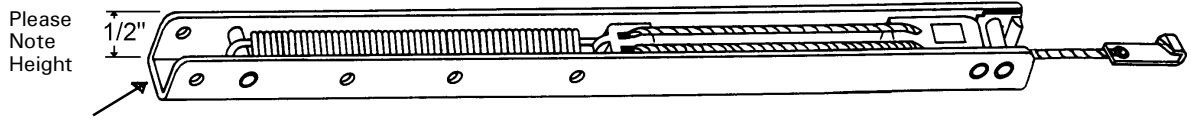

Countersunk hole is standard for our 62FC series.

Ordering Information

- 1) Measure metal channel length (Do not include any attached ends.)
- 2) Check number stamped on channel: e.g., 2130, 2510, etc.
- 3) Select our corresponding part number from the chart below.
- 4) Identify the appropriate balance end to be attached add the appropriate -1 (60-518) or -5 (900-18354) after the part number and order accordingly.
- 5) If the letter "T" appears after the number stamped, it indicates a **Top Sash Balance**; when ordering add the letter "T" at the end of our part number.

General Information

- 1) Please note that the 1/2" channel height is smaller than the usual 19/32" height on standard balances.
- 2) If metal channel length does not correspond with the number stamped on balance, consult your representative since your balance may be a special order

Channel Length	Number Stamped	Part Number	End Attached	Complete Part Number
21"	2130	62FC-2130	-1	62FC-2130-1
24"	2345	62FC-2345	-5	62FC-2345-5

LENGTH OF METAL CHANNEL	NUMBER STAMPED ON BALANCE	FOR SASH WEIGHING	OUR PART NUMBER	LENGTH OF METAL CHANNEL	NUMBER STAMPED ON BALANCE	FOR SASH WEIGHING	OUR PART NUMBER
8"	710	4-7 lbs.	62FC-710-	19"	1830	10-13 lbs.	62FC-1830-
8"	720	7-9 lbs.	62FC-720-	19"	1835	13-16 lbs.	62FC-1835-
8"	730	9-11 lbs.	62FC-730-	19"	1840	16-19 lbs.	62FC-1840-
8"	740	11-13 lbs.	62FC-740-	20"	1910	5-7 lbs.	62FC-1910-
9"	810	4-7 lbs.	62FC-810-	20"	1920	7-10 lbs.	62FC-1920-
9"	820	7-9 lbs.	62FC-820-	20"	1930	10-13 lbs.	62FC-1930-
9"	830	9-11 lbs.	62FC-830-	20"	1935	13-16 lbs.	62FC-1935-
9"	840	11-13 lbs.	62FC-840-	20"	1940	16-19 lbs.	62FC-1940-
10"	910	4-7 lbs.	62FC-910-	20"	1950	19-24 lbs.	62FC-1950-
10"	920	7-9 lbs.	62FC-920-	21"	2010	5-7 lbs.	62FC-2010-
10"	930	9-11 lbs.	62FC-930-	21"	2020	7-12 lbs.	62FC-2020-
10"	940	11-13 lbs.	62FC-940-	21"	2030	12-16 lbs.	62FC-2030-
11"	1010	4-7 lbs.	62FC-1010-	21"	2035	16-19 lbs.	62FC-2035-
11"	1020	7-9 lbs.	62FC-1020-	21"	2040	19-22 lbs.	62FC-2040-
11"	1030	9-11 lbs.	62FC-1030-	21"	2050	22-26 lbs.	62FC-2050-
11"	1040	11-13 lbs.	62FC-1040-	22"	2110	5-8 lbs.	62FC-2110-
12"	1110	5-7 lbs.	62FC-1110-	22"	2120	8-13 lbs.	62FC-2120-
12"	1120	7-9 lbs.	62FC-1120-	22"	2130	13-16 lbs.	62FC-2130-
12"	1130	9-12 lbs.	62FC-1130-	22"	2135	16-19 lbs.	62FC-2135-
12"	1140	12-15 lbs.	62FC-1140-	22"	2140	19-23 lbs.	62FC-2140-
13"	1210	5-7 lbs.	62FC-1210-	22"	2150	23-26 lbs.	62FC-2150-
13"	1220	7-9 lbs.	62FC-1220-	23"	2210	5-8 lbs.	62FC-2210-
13"	1230	9-12 lbs.	62FC-1230-	23"	2220	8-13 lbs.	62FC-2220-
13"	1240	12-15 lbs.	62FC-1240-	23"	2230	13-17 lbs.	62FC-2230-
14"	1310	5-7 lbs.	62FC-1310-	23"	2235	17-20 lbs.	62FC-2235-
14"	1320	7-10 lbs.	62FC-1320-	23"	2240	20-23 lbs.	62FC-2240-
14"	1330	10-13 lbs.	62FC-1330-	23"	2245	23-26 lbs.	62FC-2245-
14"	1340	13-16 lbs.	62FC-1340-	23"	2250	26-29 lbs.	62FC-2250-
15"	1410	5-7 lbs.	62FC-1410-	24"	2310	6-9 lbs.	62FC-2310-
15"	1420	7-10 lbs.	62FC-1420-	24"	2320	9-14 lbs.	62FC-2320-
15"	1430	10-13 lbs.	62FC-1430-	24"	2330	14-18 lbs.	62FC-2330-
15"	1435	13-15 lbs.	62FC-1435-	24"	2335	18-21 lbs.	62FC-2335-
15"	1440	15-18 lbs.	62FC-1440-	24"	2340	21-24 lbs.	62FC-2340-
16"	1510	5-7 lbs.	62FC-1510-	24"	2345	24-27 lbs.	62FC-2345-
16"	1520	7-10 lbs.	62FC-1520-	24"	2350	27-30 lbs.	62FC-2350-
16"	1530	10-14 lbs.	62FC-1530-	25"	2410	6-9 lbs.	62FC-2410-
16"	1535	14-16 lbs.	62FC-1535-	25"	2420	9-14 lbs.	62FC-2420-
16"	1540	16-19 lbs.	62FC-1540-	25"	2430	14-18 lbs.	62FC-2430-
17"	1610	5-7 lbs.	62FC-1610-	25"	2435	18-21 lbs.	62FC-2435-
17"	1620	7-10 lbs.	62FC-1620-	25"	2440	21-24 lbs.	62FC-2440-
17"	1630	10-13 lbs.	62FC-1630-	25"	2445	24-27 lbs.	62FC-2445-
17"	1635	13-16 lbs.	62FC-1635-	25"	2450	27-30 lbs.	62FC-2450-
17"	1640	16-19 lbs.	62FC-1640-	26"	2510	6-9 lbs.	62FC-2510-
18"	1710	5-7 lbs.	62FC-1710-	26"	2520	9-14 lbs.	62FC-2520-
18"	1720	7-10 lbs.	62FC-1720-	26"	2530	14-18 lbs.	62FC-2530-
18"	1730	10-13 lbs.	62FC-1730-	26"	2535	18-21 lbs.	62FC-2535-
18"	1735	13-16 lbs.	62FC-1735-	26"	2540	21-24 lbs.	62FC-2540-
18"	1740	16-19 lbs.	62FC-1740-	26"	2545	24-27 lbs.	62FC-2545-
19"	1810	5-7 lbs.	62FC-1810-	26"	2550	27-30 lbs.	62FC-2550-
19"	1820	7-10 lbs.	62FC-1820-	27"	2610	6-9 lbs.	62FC-2610-

End Brackets
Add Number to part

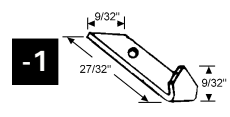

60-518



900-18354

**Due to different manufacturers methods you may have same series balances with A, B, C, D, E, F, designations instead of numeric suffix 10, 20, 30, 35, 40. Also your balance length may be the same as first two digits of stamped number. Important to measure.*

Chart Continued Next Page

62FC SERIES 1/2" X 1/2" TILT CHANNEL BALANCE

Chart Continued

LENGTH OF METAL CHANNEL	NUMBER STAMPED ON BALANCE	FOR SASH WEIGHING	OUR PART NUMBER	LENGTH OF METAL CHANNEL	NUMBER STAMPED ON BALANCE	FOR SASH WEIGHING	OUR PART NUMBER
27"	2620	9-14 lbs.	62FC-2620-	36"	3545	30-33 lbs.	62FC-3545-
27"	2630	14-18 lbs.	62FC-2630-	36"	3550	33-35 lbs.	62FC-3550-
27"	2635	18-21 lbs.	62FC-2635-	37"	3610	10-15 lbs.	62FC-3610-
27"	2640	21-24 lbs.	62FC-2640-	37"	3620	15-20 lbs.	62FC-3620-
27"	2645	24-27 lbs.	62FC-2645-	37"	3630	20-24 lbs.	62FC-3630-
27"	2650	27-30 lbs.	62FC-2650-	37"	3635	24-27 lbs.	62FC-3635-
28"	2710	6-9 lbs.	62FC-2710-	37"	3640	27-30 lbs.	62FC-3640-
28"	2720	9-14 lbs.	62FC-2720-	37"	3645	30-33 lbs.	62FC-3645-
28"	2730	14-18 lbs.	62FC-2730-	37"	3650	33-35 lbs.	62FC-3650-
28"	27350	18-21 lbs.	62FC-2735-	38"	3710	10-15 lbs.	62FC-3710-
28"	2740	21-24 lbs.	62FC-2740-	38"	3720	15-20 lbs.	62FC-3720-
28"	2745	24-27 lbs.	62FC-2745-	38"	3730	20-24 lbs.	62FC-3730-
28"	2750	27-30 lbs.	62FC-2750-	38"	3735	24-27 lbs.	62FC-3735-
29"	2810	9-12 lbs.	62FC-2810-	38"	3740	27-30 lbs.	62FC-3740-
29"	2820	12-16 lbs.	62FC-2820-	38"	3745	30-33 lbs.	62FC-3745-
29"	2830	16-20 lbs.	62FC-2830-	38"	3750	33-35 lbs.	62FC-3750-
29"	2835	20-23 lbs.	62FC-2835-	39"	3810	10-15 lbs.	62FC-3810-
29"	2840	23-27 lbs.	62FC-2840-	39"	3820	15-20 lbs.	62FC-3820-
29"	2845	27-30 lbs.	62FC-2845-	39"	3830	20-24 lbs.	62FC-3830-
29"	2850	30-33 lbs.	62FC-2850-	39"	3835	24-27 lbs.	62FC-3835-
30"	2910	9-12 lbs.	62FC-2910-	39"	3840	27-30 lbs.	62FC-3840-
30"	2920	12-16 lbs.	62FC-2920-	39"	3845	30-33 lbs.	62FC-3845-
30"	2930	16-20 lbs.	62FC-2930-	39"	3850	33-35 lbs.	62FC-3850-
30"	2935	20-23 lbs.	62FC-2935-	40"	3910	10-15 lbs.	62FC-3910-
30"	2940	23-27 lbs.	62FC-2940-	40"	3920	15-20 lbs.	62FC-3920-
30"	2945	27-30 lbs.	62FC-2945-	40"	3930	20-24 lbs.	62FC-3930-
30"	2950	30-33 lbs.	62FC-2950-	40"	3935	24-27 lbs.	62FC-3935-
31"	3010	9-13 lbs.	62FC-3010-	40"	3940	27-30 lbs.	62FC-3940-
31"	3020	13-16 lbs.	62FC-3020-	40"	3945	30-33 lbs.	62FC-3945-
31"	3030	16-20 lbs.	62FC-3030-	40"	3950	33-35 lbs.	62FC-3950-
31"	3035	20-23 lbs.	62FC-3035-	41"	4010	10-15 lbs.	62FC-4010-
31"	3040	23-27 lbs.	62FC-3040-	41"	4020	15-20 lbs.	62FC-4020-
31"	3045	27-30 lbs.	62FC-3045-	41"	4030	20-24 lbs.	62FC-4030-
31"	3050	30-33 lbs.	62FC-3050-	41"	4035	24-27 lbs.	62FC-4035-
32"	3110	9-13 lbs.	62FC-3110-	41"	4040	27-30 lbs.	62FC-4040-
32"	3120	13-16 lbs.	62FC-3120-	41"	4045	30-33 lbs.	62FC-4045-
32"	3130	16-20 lbs.	62FC-3130-	41"	4050	33-35 lbs.	62FC-4050-
32"	3135	20-23 lbs.	62FC-3135-	42"	4110	10-15 lbs.	62FC-4110-
32"	3140	23-27 lbs.	62FC-3140-	42"	4120	15-20 lbs.	62FC-4120-
32"	3145	27-30 lbs.	62FC-3145-	42"	4130	20-24 lbs.	62FC-4130-
32"	3150	30-33 lbs.	62FC-3150-	42"	4135	24-27 lbs.	62FC-4135-
33"	3210	10-14 lbs.	62FC-3210-	42"	4140	27-30 lbs.	62FC-4140-
33"	3220	14-19 lbs.	62FC-3220-	42"	4145	30-33 lbs.	62FC-4145-
33"	3230	19-23 lbs.	62FC-3230-	42"	4150	33-35 lbs.	62FC-4150-
33"	3235	23-27 lbs.	62FC-3235-	43"	4210	10-15 lbs.	62FC-4210-
33"	3240	27-30 lbs.	62FC-3240-	43"	4220	15-20 lbs.	62FC-4220-
33"	3245	30-33 lbs.	62FC-3245-	43"	4230	20-24 lbs.	62FC-4230-
33"	3250	33-35 lbs.	62FC-3250-	43"	4235	24-27 lbs.	62FC-4235-
34"	3310	10-15 lbs.	62FC-3310-	43"	4240	27-30 lbs.	62FC-4240-
34"	3320	15-20 lbs.	62FC-3320-	43"	4245	30-33 lbs.	62FC-4245-
34"	3330	20-24 lbs.	62FC-3330-	43"	4250	33-35 lbs.	62FC-4250-
34"	3335	24-27 lbs.	62FC-3335-	44"	4310	10-15 lbs.	62FC-4310-
34"	3340	27-30 lbs.	62FC-3340-	44"	4320	15-20 lbs.	62FC-4320-
34"	3345	30-33 lbs.	62FC-3345-	44"	4330	20-24 lbs.	62FC-4330-
34"	3350	33-35 lbs.	62FC-3350-	44"	4335	24-27 lbs.	62FC-4335-
35"	3410	10-15 lbs.	62FC-3410-	44"	4340	27-30 lbs.	62FC-4340-
35"	3420	15-20 lbs.	62FC-3420-	44"	4345	30-33 lbs.	62FC-4345-
35"	3430	20-24 lbs.	62FC-3430-	44"	4350	33-35 lbs.	62FC-4350-
35"	3435	24-27 lbs.	62FC-3435-	45"	4410	10-15 lbs.	62FC-4410-
35"	3440	27-30 lbs.	62FC-3440-	45"	4420	15-20 lbs.	62FC-4420-
35"	3445	30-33 lbs.	62FC-3445-	45"	4430	20-24 lbs.	62FC-4430-
35"	3350	33-35 lbs.	62FC-3350-	45"	4435	24-27 lbs.	62FC-4435-
36"	3510	10-15 lbs.	62FC-3510-	45"	4440	27-30 lbs.	62FC-4440-
36"	3520	15-20 lbs.	62FC-3520-	45"	4445	30-33 lbs.	62FC-4445-
36"	3530	20-24 lbs.	62FC-3530-	45"	4450	33-35 lbs.	62FC-4450-
36"	3535	24-27 lbs.	62FC-3535-	46"	4510	10-15 lbs.	62FC-4510-
36"	3540	27-30 lbs.	62FC-3540-	46"	4520	15-20 lbs.	62FC-4520-
				46"	4530	20-24 lbs.	62FC-4530-

End Brackets
Add Number
to part

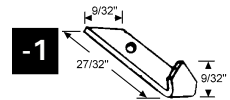

60-518



900-18354

For Balances Larger than Sizes Shown and Balances Stamped With Additional Numbers that Indicate Special Sash Weights. Please Consult Your Account Manager.

Contact Account Manager For Pricing

62P SERIES 1/2" CHANNEL BALANCE (OLD STYLE PEACHTREE)

ACTUALLY 5/8" BUT CONSIDERED 1/2" IN THE TRADE

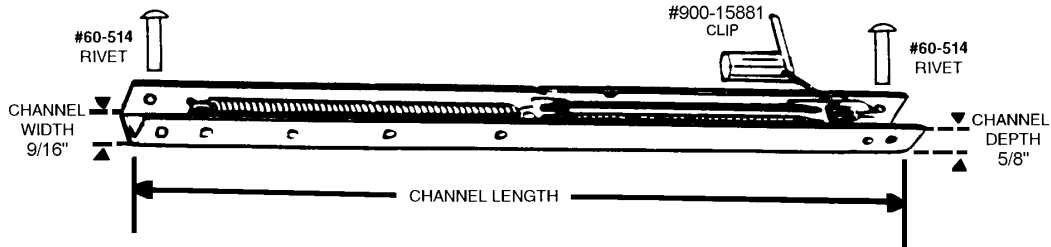

LENGTH OF METAL CHANNEL	NUMBER STAMPED ON BALANCE	OUR PART NUMBER
14-1/4"	2436, 2436-1 or 13-1/4-4	62P-2436
16-1/4"	2440, 2440-1 or 15-1/4-4	62P-2440
20-1/4"	2448	62P-2448
23-1/4"	2454, 2454-1 or 22-1/4-3	62P-2454
23-1/4"	2454E, 2454-2 or 22-1/4-3	62P-2454E
26-1/4"	2460, 2460-1 or 24-1/4-3	62P-2460
29-1/4"	2466	62P-2466
29-1/4"	2466E	62P-2466E
32-1/4"	2472, 2472-1 or 31-1/4-3	62P-2472
32-1/4"	2472E	62P-2472E
14-1/4"	3036, 3036-1 or 13-1/4-4	62P-3036
16-1/4"	3040, 3040-1 or 15-1/4-4	62P-3040
20-1/4"	3048, 3048-1 or 19-1/4-4	62P-3048
23-1/4"	3054, 3054-1 or 22-1/4-3	62P-3054
26-1/4"	3060, 3060-1 or 25-1/4-3	62P-3060
26-1/4"	3060E	62P-3060E
29-1/4"	3066	62P-3066
32-1/4"	3072, 3072-1 or 31-1/4-4	62P-3072
14-1/4"	3636, 3636-1 or 13-1/4-5	62P-3636
14-1/4"	3636T	62P-3636T
16-1/4"	3640, 3640-1 or 15-1/4-5	62P-3640
20-1/4"	3648, 3648-1 or 19-1/4-4	62P-3648
23-1/4"	3654, 3654-1 or 22-1/4-4	62P-3654
26-1/4"	3660, 3660-1 or 25-1/4-4	62P-3660
29-1/4"	3666	62P-3666
29-1/4"	3666E	62P-3666E
32-1/4"	3672, 3672-1 or 31-1/4-4	62P-3672
14-1/4"	4236, 4236-1 or 13-1/4-5	62P-4236
14-1/4"	4236T	62P-4236T
16-1/4"	4240, 4240-1 or 15-1/4-6	62P-4240
16-1/4"	4240E, 4240-1 or 15-1/4-6	62P-4240E
16-1/4"	4240T, 4240-2 or 15-1/4-6	62P-4240T
20-1/4"	4248, or 4248-1 or 19-1/4-9	62P-4248
20-1/4"	4248E, 4248-2 or 19-1/4-9	62P-4248E
20-1/4"	4248T, 4248-3 or 19-1/4-9	62P-4248T
23-1/4"	4254, 4254-1 or 22-1/4-4	62P-4254
23-1/4"	4254E, 4254-2 or 22-1/4-4	62P-4254E
23-1/4"	4254T, 4254-3 or 22-1/4-9	62P-4254T
26-1/4"	4260, 4260-1 or 25-1/4-4	62P-4260
26-1/4"	4260E, 4260-2 or 25-1/4-5	62P-4260E
26-1/4"	4260T, 4260-3 or 25-1/4-5	62P-4260T
29-1/4"	4266	62P-4266
29-1/4"	4266E	62P-4266E
29-1/4"	4266T	62P-4266T
32-1/4"	4272-1 or 31-1/4-5	62P-4272
32-1/4"	4272-2 or 31-1/4-6	62P-4272E
32-1/4"	4272-3 or 31-1/4-9	62P-4272T

62R SERIES CHANNEL BALANCE (RUSCO)

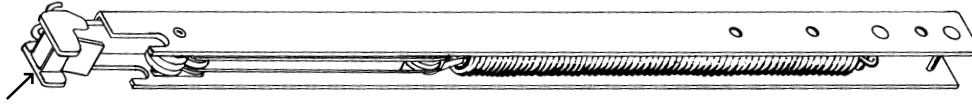

62-538
Balance Foot
included with Balance Purchase

ORDERING INFORMATION

- 1) Measure metal channel length.
- 2) Check number stamped on channel.
- 3) Select our corresponding part number from the chart below.

LENGTH OF METAL CHANNEL	NUMBER STAMPED ON BALANCE	OUR PART NUMBER	LENGTH OF METAL CHANNEL	NUMBER STAMPED ON BALANCE	OUR PART NUMBER
10-1/2"	10A-C	62R-10A	24"	23E	62R-23E
10-1/2"	10B-C	62R-10B	24"	23F	62R-23F
10-1/2"	10D-C	62R-10D	23-1/16"	23S	62R-23S
10-3/16"	10-S	62R-10S		2440	62R-24D
11-7/8"	11A	62R-11A	24-3/8"	24F	62R-24F
11-7/8"	11B	62R-11B	24-11/32"	24S	62R-24S
11-7/8"	11D	62R-11D	26"	25B	62R-25B
		62R-13C	26"	25C	62R-25C
14-3/8"	14A	62R-14A	26"	25D	62R-25D
15-7/8"	15A	62R-15A	25-5/8"	25S	62R-25S
15-7/8"	15B	62R-15B	26-1/2"	26C	62R-26C
		62R-15C	26-25/32"	26S	62R-26S
15-7/8"	15D	62R-15D	27-7/8"	27A	62R-27A
16-7/8"	22F	62R-22F	27-7/8"	27B	62R-27B
16-11/16"	16A-C	62R-16A	27-7/8"	27C	62R-27C
16-11/16"	16B-C	62R-16B	27-7/8"	27D	62R-27D
16-11/16"	16D-C	62R-16D	27-15/16"	27S	62R-27S
16-11/16"	16E-C	62R-16E	27-7/8"	27E	62R-27E
16-1/8"	16F	62R-16F	29"	28A-C	62R-28A
16-13/32"	16S	62R-16S	29"	28B-C	62R-28B
16-11/16"	16S-11	62R-16S-11	29"	28C-C	62R-28C
16-11/16"	16S-18	62R-16S-18	29"	28D-C	62R-28D
18"	17A	62R-17A	29"	28E-C	62R-28E
18"	17B	62R-17B	28-9/16"	28S-28	62R-28S
18"	17D	62R-17D	29"	28F-C	62R-28F
18"	17C	62R-17C	32"	31B	62R-31B
18-1/4"	18B	62R-18B	32"	31C	62R-31C
18-21/32"	18S	62R-18S	32"	31D	62R-31D
19-7/8"	19A	62R-19A	32"	31E	62R-31E
19-7/8"	19B	62R-19B			62R-32D
19-7/8"	19D	62R-19D	33-7/8"	33A	62R-33A
19-7/8"	19S	62R-19S	33-7/8"	33B	62R-33B
20-5/8"	20C	62R-20C	33-7/8"	33C	62R-33C
20-5/8"	20D	62R-20D	33-7/8"	33D	62R-33D
20-3/4"	20E	62R-20E	33-7/8"	33E	62R-33E
20-3/8"	20S	62R-20S			62R-34D
21-7/8"	21A	62R-21A	35-7/8"	35A-C	62R-35A
21-7/8"	21B	62R-21B	35-7/8"	35B-C	62R-35B
21-7/8"	21C	62R-21C	35-7/8"	35C-C	62R-35C
21-7/8"	21D	62R-21D	35-7/8"	35D-C	62R-35D
21-15/16"	21S	62R-21S	35-7/8"	35E-C	62R-35E
22-13/16"	22A	62R-22A	39-7/8"	39A	62R-39A
22-13/16"	22B	62R-22B	39-7/8"	39B	62R-39B
22-13/16"	22C	62R-22C	39-7/8"	39C	62R-39C
22-13/16"	22D	62R-22D	39-7/8"	39D	62R-39D
22-13/16"	22F	62R-22F	39-7/8"	39E	62R-39E
22-9/16"	22S-23	62R-22S	42-7/8"	42A	62R-42A
22-13/16"	22E-C	62R-22E	42-7/8"	42B	62R-42B
23-7/8"	23A	62R-23A	42-7/8"	42C	62R-42C
23-7/8"	23B	62R-23B	42-7/8"	42D	62R-42D
23-7/8"	23C	62R-23C	42-7/8"	42E	62R-42E
23-7/8"	23D	62R-23D			

Screen Spacer

900-19109

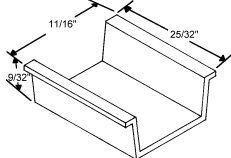

62R Series Balance Accessories

Balance Frame Retainer

900-19165

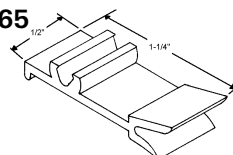

Sash Stop

900-19107

Black

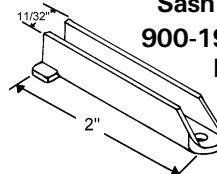

Balance Hook

900-19163

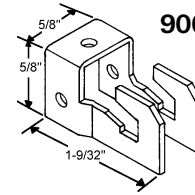

Balance Foot

62-538

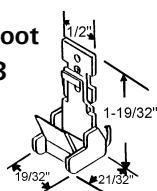

Black Roller Assembly

900-19102

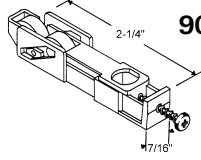

50-783B

Black

Sweep height graduates from 9/32" to 1/8" max.

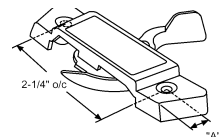
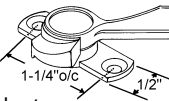

900-19112LH Shown
900-19112RH Opposite

Contact Account Manager For Pricing

TOLL FREE 800-352-0800

2003, SBI®

strybug

25

Return to Table of Contents

62V SERIES OVERHEAD BALANCES

OLD STYLE OBSOLETE
BALANCE AND RELATED
COMPONENTS ARE SHOWN
FOR
REFERENCE ONLY

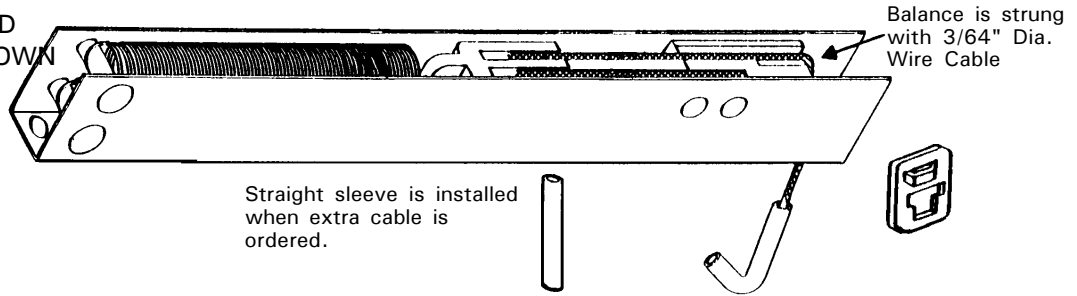

New Style

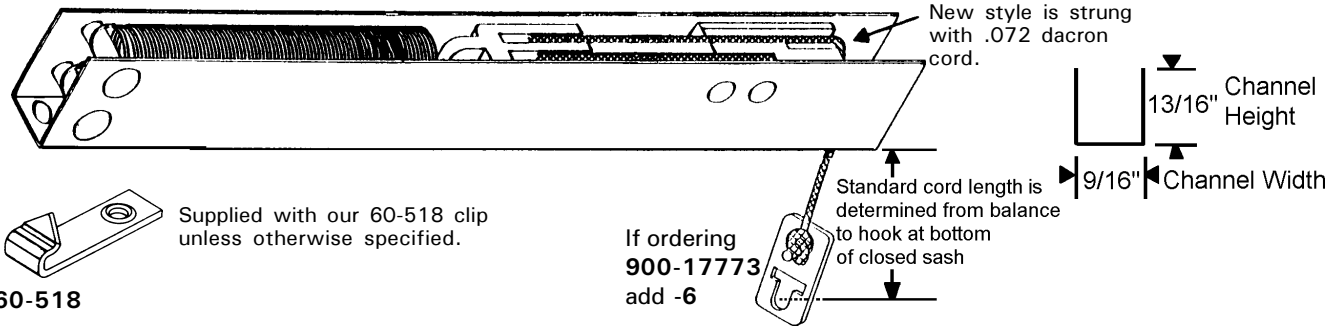

Ordering Information

- 1) Measure channel length.
- 2) Check number stamped on balance.
- 3) Determine the clip to be attached to balance.
- 4) Customer must determine how much cord hangs down from the balance when the window is closed. If more cord than the standard lengths shown is required, specify number of extra inches required when ordering. If additional cord is required, add plus sign (+) followed by number of extra inches needed. e.g. if

ordering a 153-D balance with our 900-17773 clip attached and a 40" of cord is required. If ordering with our 900-17773 attached, add -6 after our part number. Example: 62-153D+10-6

General Information

- 1) Balances are supplied with either one or two springs. If the number stamped on your balance is followed by the letter "D" it denotes a double spring.

LENGTH OF METAL CHANNEL	NUMBER STAMPED ON BALANCE	OUR PART NUMBER		WEIGHT RANGE (2 BALANCES)
13-1/4"	112	62V-112	Standard extended cord length from balance 20"	4 to 10 lbs.
13-1/4"	112	62V-112+	(Specify extra inches of cord required)	
13-1/4"	112-D	62V-112D	Standard extended cord length from balance 20"	10 to 18 lbs.
13-1/4"	112-D	62V-112D+	(Specify extra inches of cord required)	
16-1/4"	122	62V-122	Standard extended cord length from balance 25"	6 to 12 lbs.
16-1/4"	122	62V-122+	(Specify extra inches of cord required)	
16-1/4"	122-D	62V-122D	Standard extended cord length from balance 25"	12 to 22 lbs.
16-1/4"	122-D	62V-122D+	(Specify extra inches of cord required)	
19-3/4"	153	62V-153	Standard extended cord length from balance 30"	8 to 16 lbs.
19-3/4"	153	62V-153+	(Specify extra inches of cord required)	
19-3/4"	153-D	62V-153D	Standard extended cord length from balance 30"	16 to 28 lbs.
19-3/4"	153-D	62V-153D+	(Specify extra inches of cord required)	
23-3/4"	163	62V-163	Standard extended cord length from balance 36"	10 to 18 lbs.
23-3/4"	163	62V-163+	(Specify extra inches of cord required)	
23-3/4"	163-D	62V-163D	Standard extended cord length from balance 36"	18 to 32 lbs.
23-3/4"	163-D	62V-163D+	(Specify extra inches of cord required)	
28-1/4"	183	62V-183	Standard extended cord length from balance 40"	10 to 16 lbs.
28-1/4"	183	62V-183+	(Specify extra inches of cord required)	
28-1/4"	183-D	62V-183D	Standard extended cord length from balance 40"	16 to 34 lbs.
28-1/4"	183-D	62V-183D+	(Specify extra inches of cord required)	

Contact Account Manager For Pricing

62W SERIES OVERHEAD BALANCES

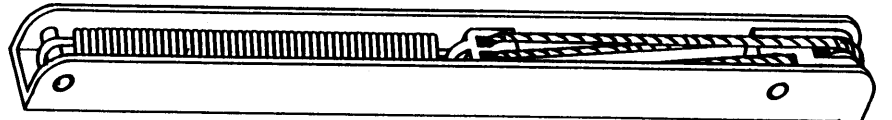

If ordering with our optional 60-518 clip attached, Please add "-1" after the part number.



If ordering with our optional 900-18354 clip attached, Please add "-5" after the part number.

62W-500
Black
Must be ordered separately

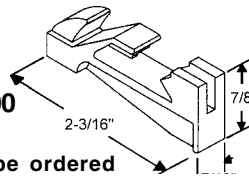

Standard cord length is determined from balance to hook at bottom of closed sash

Ordering Information

- 1) Measure metal channel length.
- 2) Check number stamped on balance.
- 3) Select our corresponding part number from the chart below and order accordingly
- 4) Standard clip shown will be attached unless otherwise specified.

General Information

- 1) Determine the balance clip to be attached and order accordingly: Standard, 60-518 or 900-18354.
- 2) If cord lengths are different from the standard lengths shown a plus sign (+) and the extra number of inches should be added after the part number.

Note: If your balance is stamped with the letters "DBS", refer to our DS balances, since their manufacturing specifications are the same.

Example Ordering Chart

Channel Length	Number Stamped	Part Number	Extra Cord (In Inches)	End Attached	Complete Part Number
15-1/4"	122	62W-122	10"	-5	62W-122+10-5
19-1/4"	152	62W-152	--	-1	62W-152-1

LENGTH OF METAL CHANNEL	NUMBER STAMPED ON BALANCE	OUR PART NUMBER		SASH WEIGHT PER PAIR
12-3/4"	111	62W-111	Standard Cord 20" with standard clip attached	4- 7 lbs.
12-3/4"	111	62W-111+	Specify extra inches of cord length)	4- 7 lbs.
12-3/4"	112	62W-112	Standard Cord 20" with standard clip attached	7-11 lbs.
12-3/4"	112	62W-112+	(Specify extra inches of cord length)	7-11 lbs.
15-1/4"	121	62W-121	Standard Cord 25" with standard clip attached	4-8 lbs.
15-1/4"	121	62W-121+	(Specify extra inches of cord length)	4-8 lbs.
15-1/4"	122	62W-122	Standard Cord 25" with standard clip attached	8-12 lbs.
15-1/4"	122	62W-122+	(Specify extra inches of cord length)	8-12 lbs.
15-1/4"	122DS	62W-122DS	Standard Cord 32" with standard clip attached	15-18 lbs.
15-1/4"	122DS	62W-122DS+	(Specify extra inches of cord length)	15-18 lbs.
19-1/4"	151	62W-151	Standard Cord 33" with standard clip attached	5-9 lbs.
19-1/4"	151	62W-151+	(Specify extra inches of cord length)	5-9 lbs.
19-1/4"	152	62W-152	Standard Cord 33" with standard clip attached	9-13 lbs.
19-1/4"	152	62W-152+	(Specify extra inches of cord length)	9-13 lbs.
19-1/4"	153	62W-153	Standard Cord 33" with standard clip attached	13-16 lbs.
19-1/4"	153	62W-153+	(Specify extra inches of cord length)	13-16 lbs.
19-1/4"	153HD	62W-153HD	Standard Cord 30" with standard clip attached	16-18 lbs.
19-1/4"	153HD	62W-153HD+	(Specify extra inches of cord length)	16-18 lbs.
23-1/4"	162	62W-162	Standard Cord 36" with standard clip attached	9-14 lbs.
23-1/4"	162	62W-162+	(Specify extra inches of cord length)	9-14 lbs.
23-1/4"	163	62W-163	Standard Cord 36" with standard clip attached	13-16 lbs.
23-1/4"	163	62W-163+	(Specify extra inches of cord length)	13-16 lbs.
23-1/4"	163HD	62W-163HD	Standard Cord 36" with standard clip attached	15-17 lbs.
23-1/4"	163HD	62W-163HD+	(Specify extra inches of cord length)	15-17 lbs.
25"	24DS	62W-24DS	Standard Cord 36" with standard clip attached	34 lbs.
25"	24DS	62W-24DS+	(Specify extra inches of cord length)	34 lbs.
27-1/4"	183	62W-183	Standard Cord 40" with standard clip attached	17-20 lbs.
27-1/4"	183	62W-183+	(Specify extra inches of cord length)	17-20 lbs.
27-1/4"	183HD	62W-183	Standard Cord 36" with standard clip attached	24-27 lbs.
27-1/4"	183HD	62W-183+	(Specify extra inches of cord length)	24-27 lbs.
29"	28DS	62W-28DS	Standard Cord 36" with standard clip attached	27-30 lbs.
29"	28DS	62W-28DS+	(Specify extra inches of cord length)	27-30 lbs.
31"	30DS	62W-30DS	Standard Cord 36" with standard clip attached	27-30 lbs.
31"	30DS	62W-30DS+	(Specify extra inches of cord length)	27-30 lbs.
34"	33DS	62W-33DS	Standard Cord 38" with standard clip attached	27-30 lbs.
34"	33DS	62W-33DS+	(Specify extra inches of cord length)	27-30 lbs.
36"	35DS	62W-35DS	Standard Cord 36" with standard clip attached	27-30 lbs.
36"	35DS	62W-35DS+	(Specify extra inches of cord length)	27-30 lbs.