

60 SERIES CHANNEL BALANCES

1/2" CHANNEL BALANCE

Actually 5/8" But Considered 1/2" in the Trade

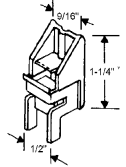

Choose from a variety of top & bottom guides. See pages 6 & 7.

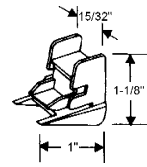
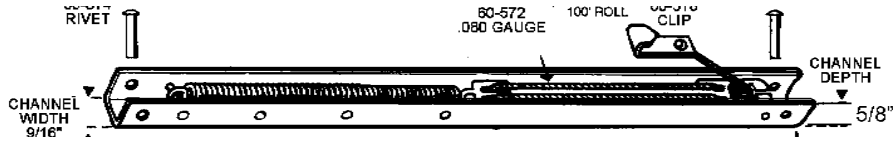

Choose from a variety of top & bottom guides. See pages 6 & 7.

General Information

- Balance prices do not include bracket costs.
- Sash weights indicated below are weights 2 balances per sash will carry with no weatherstrip friction considered.
- Balances stamped with a 3 digit number (e.g., 122, 183, 143) or a 2 digit number (e.g., 15, 18, 19) will require you contact your sales representative for more information; such as exact channel length, type of ends attached, etc.
- Any other number/letter variations should first be discussed with your representative to insure that your order will be filled correctly.
- For sash weights over those indicated on chart below, please provide the following information:
 - number stamped on balance _____
 - balance length _____
 - sash weight _____
 - upper or lower sash _____
 - e) 2 or 4 balances per sash _____

All special weight balances are limited travel and require repositioning the existing sash stops. Special weight balances were usually stamped with a 4 digit number followed by a 2 digit number (e.g. 2640 42 or 2690 42 indicates 2-27" balances carrying a 42lb sash).

Part number examples: Stamped 2640 42:

- 60-26S42L - 27" 42lb - lower sash, 2 balances
- 60-26S42U - 27" 42lb - upper sash, 2 balances
- 60-26S42L4 - 27" 42lb - lower sash, 4 balances/sash
- 60-26S42U4 - 27" 42lb - upper sash, 4 balances/sash

Ordering Information

- Measure metal channel balance length (Do not include plastic ends.)
- Check number stamped on channel: e.g., 2010, 28A, 3620 etc.
- Select our corresponding part number from the chart below.
- To identify the top and bottom ends to be attached, refer to pages 6 and 7.

Note: Top & bottom balance ends must be ordered separately. If you want ends attached, add the letter "A" to the suffix of the part number when ordering.

Please Note (Important New Information)

- Due to recent changes by manufactures on balances 29" & above, there are now 5 weight ranges as opposed to 4.
- If your existing balance has a "BSI" stamped on the face of the balance by the 4 digit number, order exactly as seen on this chart.
- If your existing balance does not have BSI stamped on it & your balance's 4 digit number has a 40 suffix - e.g. 2840, 2940, 3040, 3640 etc. you have the old style balance & for 29" balances & above - order 2850, 2950, 3050, 3650 etc.
- If you are unsure, weigh your sash & choose from the weight charts indicated below.

NOTE: With the 60 Series take out system, the sash balance becomes part of the sash. Therefore when calculating sash weights, you must add the physical balance weight to the sash weights.

For weights above those listed in your chart, contact your account manager.

Length of Metal Channel	Number Stamped on Balance			Number Stamped on Balance			Number Stamped on Balance			Number Stamped on Balance			Number Stamped on Balance		
	Sash Weight	Our Part Number		Sash Weight	Our Part Number		Sash Weight	Our Part Number		Sash Weight	Our Part Number		Sash Weight	Our Part Number	
13"	1210	3-6 lbs	60-121	1220	6-9 lbs	60-122	1230	9-11 lbs	60-123	1240	11-12 lbs	60-124			
14"	1310	3-6 lbs	60-131	1320	6-9 lbs	60-132	1330	9-11 lbs	60-133	1340	11-12 lbs	60-134			
14"	1410	4-6 lbs	60-141	1420	6-10 lbs	60-142	1430	10-12 lbs	60-143	1440	12-13 lbs	60-144			
16"	1510	4-6 lbs	60-151	1520	6-10 lbs	60-152	1530	10-12 lbs	60-153	1540	12-13 lbs	60-154			
17"	1610	5-8 lbs	60-161	1620	8-12 lbs	60-162	1630	12-14 lbs	60-163	1640	14-19 lbs	60-164			
18"	1710	5-8 lbs	60-171	1720	8-12 lbs	60-172	1730	12-14 lbs	60-173	1740	14-17 lbs	60-174			
19"	1810	5-8 lbs	60-181	1820	8-12 lbs	60-182	1830	12-14 lbs	60-183	1840	14-17 lbs	60-184			
20"	1910	5-8 lbs	60-191	1920	8-12 lbs	60-192	1930	12-14 lbs	60-193	1940	14-17 lbs	60-194			
21"	2010	5-8 lbs	60-201	2020	8-12 lbs	60-202	2030	12-15 lbs	60-203	2040	15-23 lbs	60-204			
22"	2110	5-8 lbs	60-211	2120	8-12 lbs	60-212	2130	12-15 lbs	60-213	2140	15-23 lbs	60-214			
23"	2210	5-8 lbs	60-221	2220	8-12 lbs	60-222	2230	12-19 lbs	60-223	2240	19-23 lbs	60-224			
24"	2310	5-8 lbs	60-231	2320	9-15 lbs	60-232	2330	15-18 lbs	60-233	2340	18-23 lbs	60-234			
25"	2410	5-9 lbs	60-241	2420	9-15 lbs	60-242	2430	15-19 lbs	60-243	2440	19-24 lbs	60-244			
26"	2510	5-9 lbs	60-251	2520	9-15 lbs	60-252	2530	15-19 lbs	60-253	2540	19-25 lbs	60-254			
27"	2610	5-9 lbs	60-261	2620	9-13 lbs	60-262	2630	13-19 lbs	60-263	2640	19-26 lbs	60-264			
28"	2710	5-9 lbs	60-271	2720	9-13 lbs	60-272	2730	13-19 lbs	60-273	2740	19-26 lbs	60-274			
29"	2810	7-12 lbs	60-281	2820	12-16 lbs	60-282	2830	16-23 lbs	60-283	2840	23-28 lbs	60-284	2850	28-32 lbs	60-285
30"	2910	7-12 lbs	60-291	2920	12-16 lbs	60-292	2930	16-23 lbs	60-293	2940	23-28 lbs	60-294	2950	28-32 lbs	60-295
31"	3010	7-12 lbs	60-301	3020	12-16 lbs	60-302	3030	16-23 lbs	60-303	3040	23-28 lbs	60-304	3050	28-32 lbs	60-305
32"	3110	7-12 lbs	60-311	3120	12-16 lbs	60-312	3130	16-23 lbs	60-313	3140	23-28 lbs	60-314	3150	28-32 lbs	60-315
33"	3210	8-13 lbs	60-321	3220	13-18 lbs	60-322	3230	18-23 lbs	60-323	3240	23-28 lbs	60-324	3250	28-32 lbs	60-325
34"	3310	8-13 lbs	60-331	3320	13-18 lbs	60-332	3330	18-23 lbs	60-333	3340	23-28 lbs	60-334	3350	28-32 lbs	60-335
35"	3410	8-13 lbs	60-341	3420	13-18 lbs	60-342	3430	18-23 lbs	60-343	3440	23-30 lbs	60-344	3450	30-34 lbs	60-345
36"	3510	8-13 lbs	60-351	3520	13-18 lbs	60-352	3530	18-23 lbs	60-353	3540	23-30 lbs	60-354	3550	30-35 lbs	60-355
37"	3610	8-13 lbs	60-361	3620	13-18 lbs	60-362	3630	18-23 lbs	60-363	3640	23-30 lbs	60-364	3650	30-35 lbs	60-365
38"	3710	8-13 lbs	60-371	3720	13-18 lbs	60-372	3730	18-23 lbs	60-373	3740	23-30 lbs	60-374	3750	30-35 lbs	60-375
39"	3810	9-14 lbs	60-381	3820	14-19 lbs	60-382	3830	19-24 lbs	60-383	3840	24-30 lbs	60-384	3850	30-35 lbs	60-385
40"	3910	9-14 lbs	60-391	3920	14-19 lbs	60-392	3930	19-24 lbs	60-393	3940	24-30 lbs	60-394	3950	30-35 lbs	60-395
41"	4010	9-14 lbs	60-401	4020	14-19 lbs	60-402	4030	19-23 lbs	60-403	4040	23-30 lbs	60-404	4050	30-35 lbs	60-405
42"	4110	9-14 lbs	60-411	4120	14-19 lbs	60-412	4130	19-24 lbs	60-413	4140	24-30 lbs	60-414	4150	30-35 lbs	60-415
43"	4210	9-14 lbs	60-421	4220	14-19 lbs	60-422	4230	19-24 lbs	60-423	4240	24-30 lbs	60-424	4250	30-35 lbs	60-425
44"	4310	9-14 lbs	60-431	4320	14-19 lbs	60-432	4330	19-24 lbs	60-433	4340	24-30 lbs	60-434	4350	30-35 lbs	60-435
45"	4410	9-14 lbs	60-441	4420	14-19 lbs	60-442	4430	19-24 lbs	60-443	4440	24-30 lbs	60-444	4450	30-35 lbs	60-445
46"	4510	9-14 lbs	60-451	4520	14-19 lbs	60-452	4530	19-24 lbs	60-453	4540	24-30 lbs	60-454	4550	30-35 lbs	60-455
47"	4610	9-14 lbs	60-461	4620	14-19 lbs	60-462	4630	19-24 lbs	60-463	4640	24-30 lbs	60-464	4650	30-35 lbs	60-465
48"	4710	9-14 lbs	60-471	4720	14-19 lbs	60-472	4730	19-24 lbs	60-473	4740	24-30 lbs	60-474	4750	30-35 lbs	60-475
49"	4810	9-14 lbs	60-481	4820	14-19 lbs	60-482	4830	19-24 lbs	60-483	4840	24-32 lbs	60-484	4850	32-35 lbs	60-485
50"	4910	9-14 lbs	60-491	4920	14-19 lbs	60-492	4930	19-24 lbs	60-493	4940	24-32 lbs	60-494	4950	32-35 lbs	60-495

TOLL FREE 800-352-0800

2003, SBI®

strybug

5

rev. 10/18/04

60 SERIES BALANCE ACCESSORIES

POPULAR COMBINATIONS

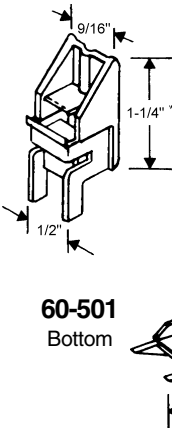
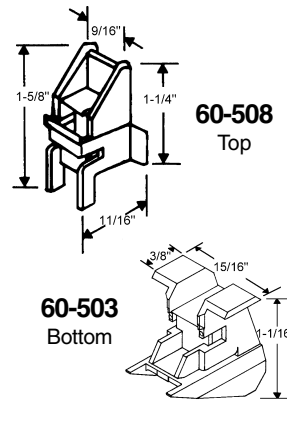
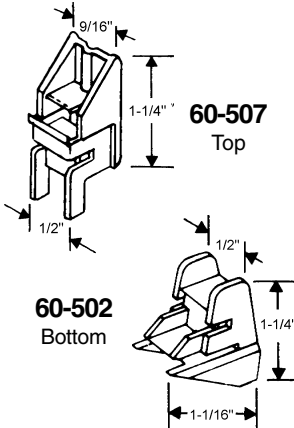
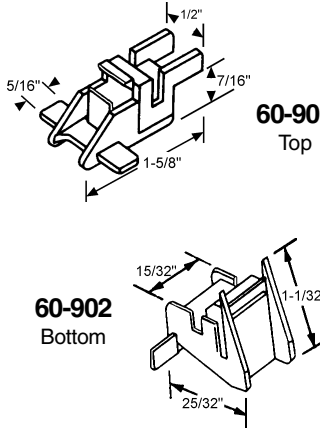
 <p>60-507 Top</p> <p>60-501 Bottom</p> <p>Most Popular Combination</p>	 <p>60-508 Top</p> <p>60-503 Bottom</p>	 <p>60-507 Top</p> <p>60-502 Bottom</p> <p>Seasonall</p>	 <p>60-901 Top</p> <p>60-902 Bottom</p> <p>Crossly</p>
---	--	---	--

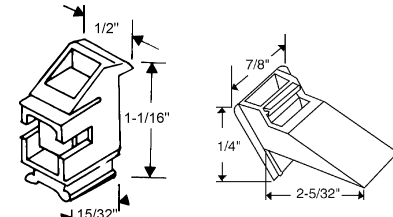
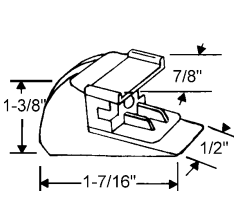
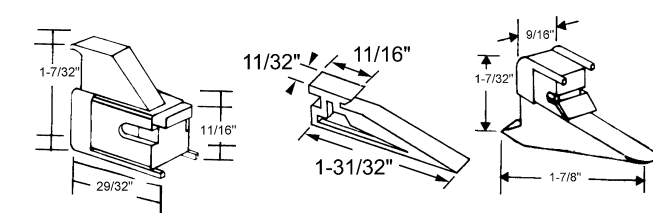
 <p>60-560 Top</p> <p>60-610 Sash Guide</p> <p>Acorn</p>	 <p>60-561 Bottom Usually Black</p>	 <p>60-511 Top</p> <p>60-701 Sash Guide</p> <p>60-512 Bottom</p> <p>Ida</p>
--	---	---

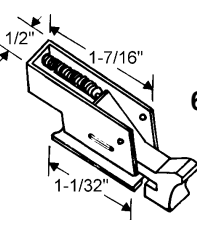
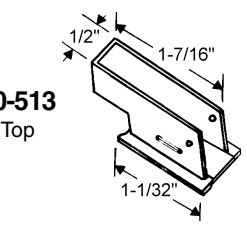
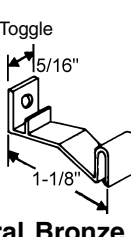
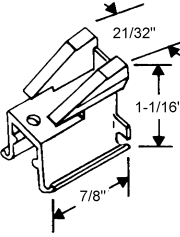
 <p>60-513 Top</p>	 <p>60-513B Body Only</p>	<p>Metal Toggle</p>  <p>60-592 Used with 60-513B</p>	 <p>60-505 Bottom must be installed with screw 20-046 at time of installation</p>
--	---	---	--

General Bronze

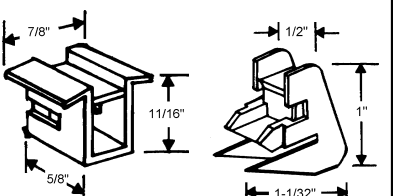
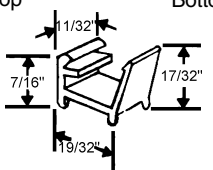
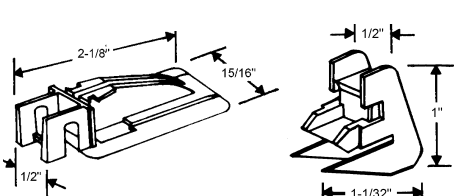
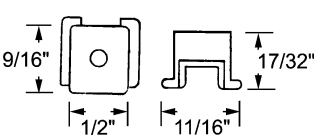
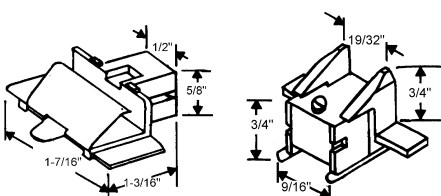
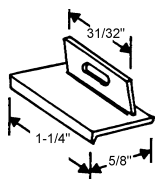
 <p>60-506 Top</p> <p>60-500 Bottom</p>  <p>60-515 Extender</p> <p>Capitol</p>	 <p>60-509 Top</p> <p>60-500 Bottom</p>  <p>60-614 Sash Guide</p> <p>WT Industries</p>	 <p>60-510 Top</p> <p>60-504 Bottom</p>  <p>60-615 Sash Guide Not Available - Use 60-665</p> <p>Crossly</p>
--	---	--

60 SERIES BALANCE ACCESSORIES

POPULAR COMBINATIONS

Riveted on Unless Otherwise Indicated

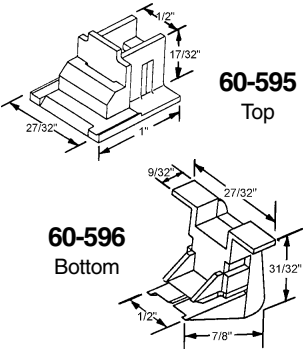
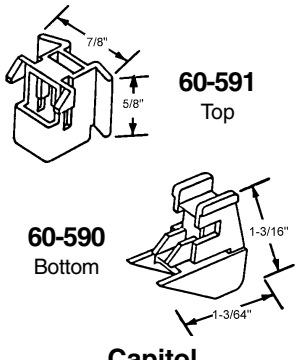
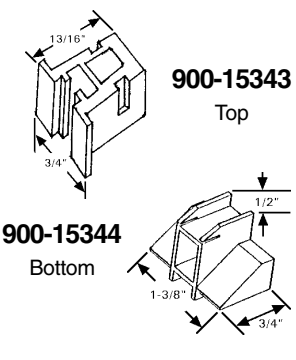
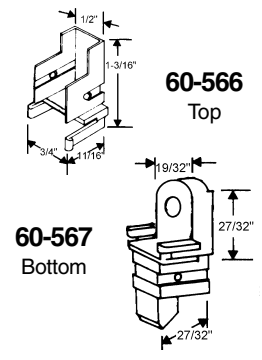
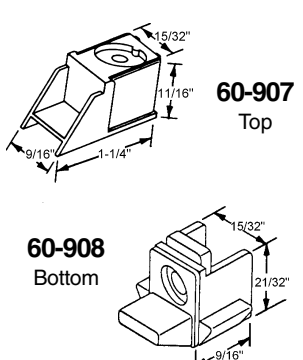
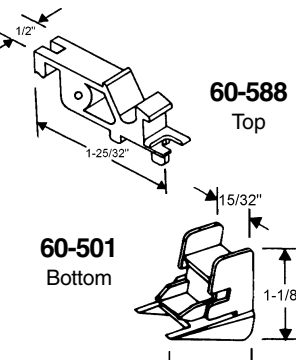
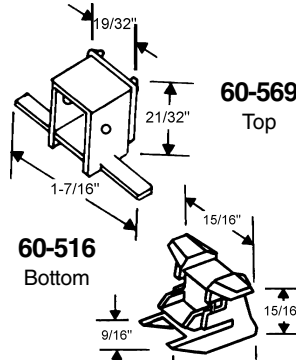
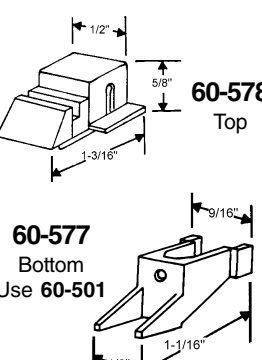
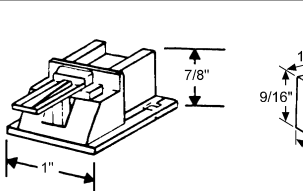
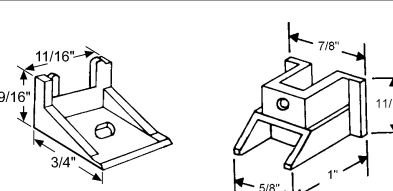
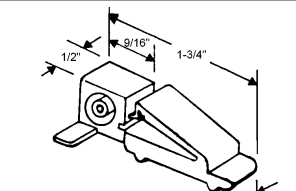
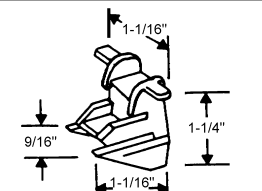
 <p>60-595 Top</p> <p>60-596 Bottom</p> <p>Pan Am</p>	 <p>60-591 Top</p> <p>60-590 Bottom</p> <p>Capitol Original in Clear Plastic</p>	 <p>900-15343 Top</p> <p>900-15344 Bottom</p> <p>Weathervane</p>	 <p>60-566 Top</p> <p>60-567 Bottom</p> <p>Burcon</p>
 <p>60-907 Top</p> <p>60-908 Bottom</p> <p>Silver Line</p>	 <p>60-588 Top</p> <p>60-501 Bottom</p> <p>General Bronze</p>	 <p>60-569 Top</p> <p>60-516 Bottom</p> <p>Rollyson</p>	 <p>60-578 Top</p> <p>60-577 Bottom Use 60-501</p> <p>Bellhouse</p>
 <p>60-575 Top</p>	 <p>60-616 Sash Guide</p> <p>60-576 Bottom</p> <p>Pan Am</p>	 <p>60-563</p> <p>Jones</p>	 <p>60-564</p>

TOP BRACKETS

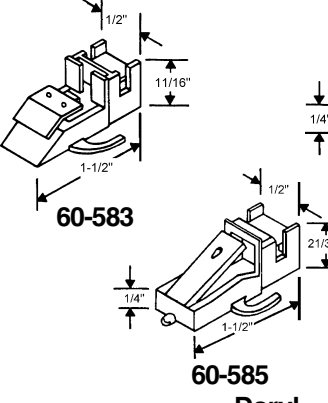
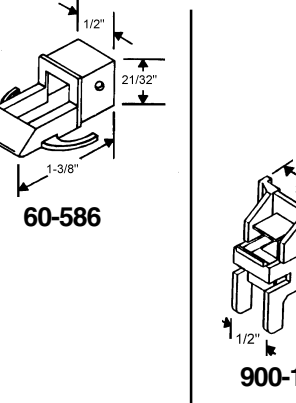
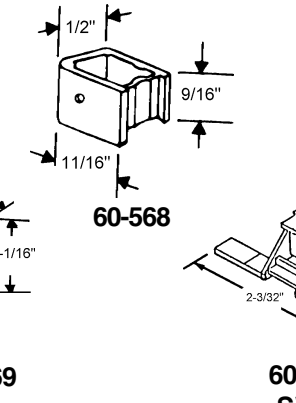
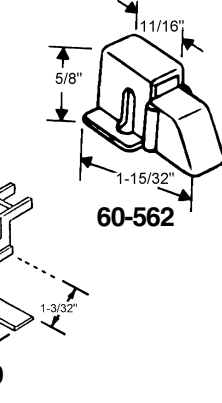
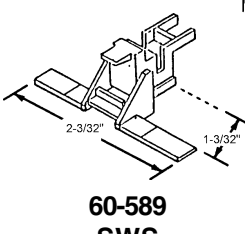
 <p>60-583</p> <p>60-585 Daryl</p>	 <p>60-586</p>	 <p>900-10269</p>	 <p>60-568</p> <p>60-562</p>
		 <p>60-589 SWS</p>	

TOLL FREE 800-352-0800
2003, SBI®

strybug

7

Return to Table of Contents

60 SERIES BALANCE ACCESSORIES

BOTTOM BRACKETS

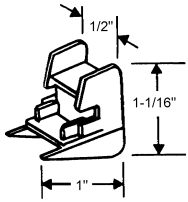

60-587

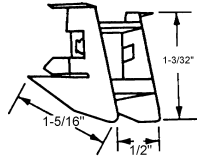

60-598

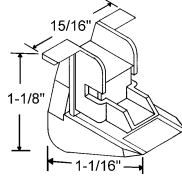

60-909

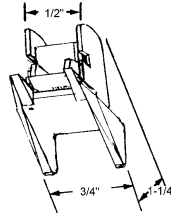

60-597

BALANCE GUIDE ASSEMBLY

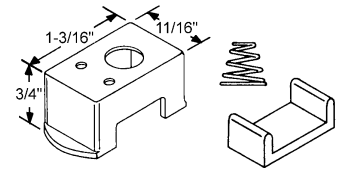

60-906
3 piece

Louisiana Pacific

BALANCE CLIPS

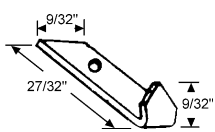

60-518

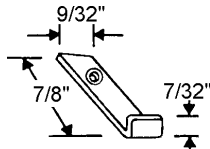

60-517

RIVETS

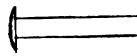

60-514
3/32" Diameter
5/8" Length

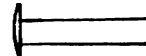

60-570
1/8" Diameter
5/8" Length

RIVET & DRIVE SCREW ASSEMBLY



20-183
Used when no rivet tool is available or if you stock without ends attached

INTERLOCK BLOCK

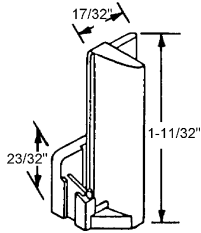

60-625 Shown
60-626 Opposite

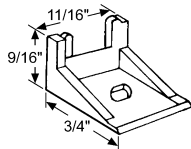

60-616
Pan Am

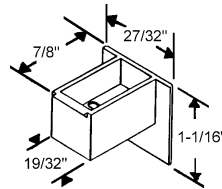

60-632
King

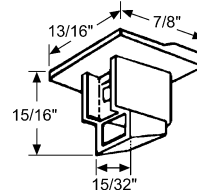

60-600

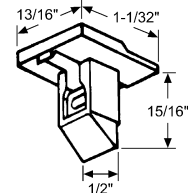

60-601

PLASTIC TOP SASH GUIDES - BY HEIGHT

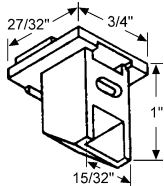

60-621

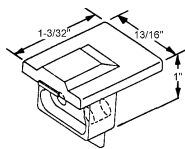

60-630

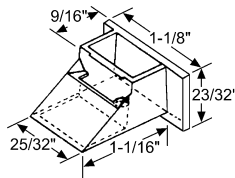

60-629

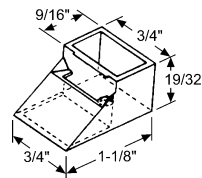

60-643

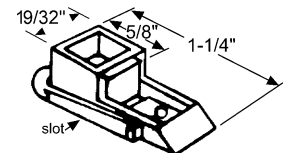

60-605 Shown
60-606 Opposite
Weatherstripping Not Included

Ida

Capitol

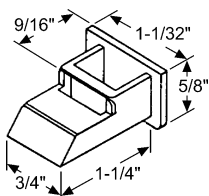

60-645

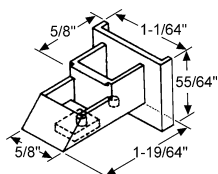

60-651A
RH & LH Set

Sugarcreek

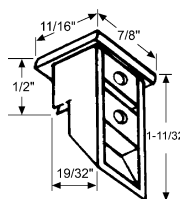

60-602 White
60-602B Black

900-13531A
RH & LH Set
Black

Mannix

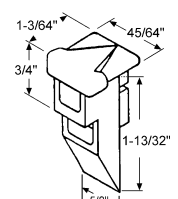
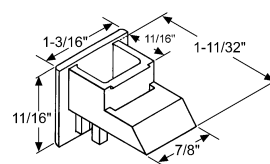

60-624

Graham

60 SERIES BALANCE ACCESSORIES

PLASTIC TOP SASH GUIDES - BY HEIGHT

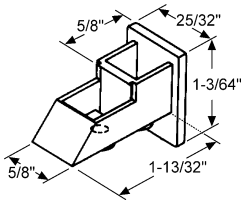

60-653

Crossly

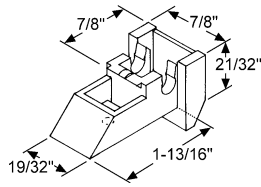

60-654

Seasonall

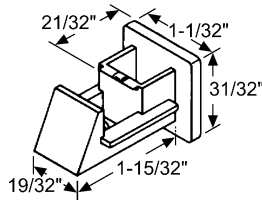

60-641

Binnings

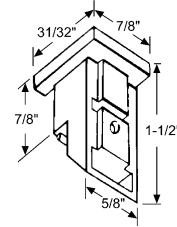

60-612

Hole center
up 9/16" from bottom

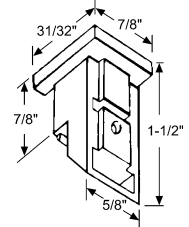

900-1852

.185 Dia. Hole.
Hole center up 17/32"
from bottom

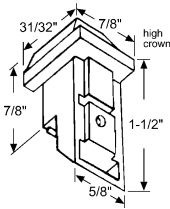

60-613 White

60-613B Black

.160 Dia. Hole.

Hole center up 9/16" fr. bottom

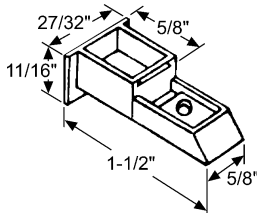

60-618

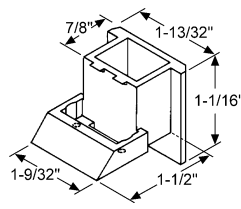

60-646

Black

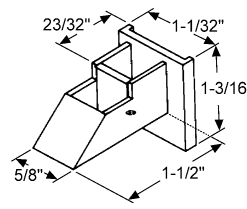

60-652A

RH & LH Set

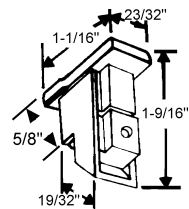

60-604

AlSCO/Anaconda

Howmet

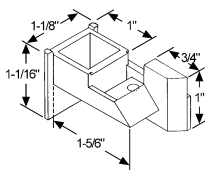

60-666

RH & LH Set Black

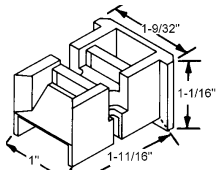

60-648

Black

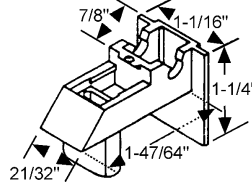

60-657WH White

60-657BL Black

60-657BR Brown

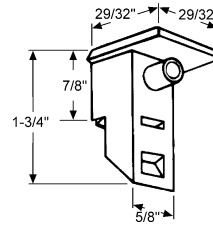

60-622

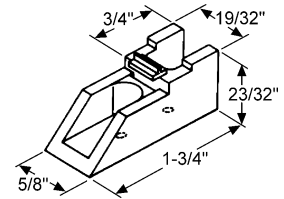

60-647

Kawneer/Widing

Fiberlux

Reynolds

Milco

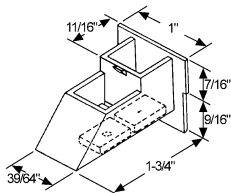

60-659

King

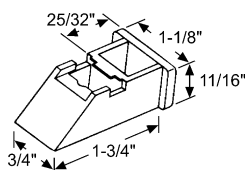

60-642

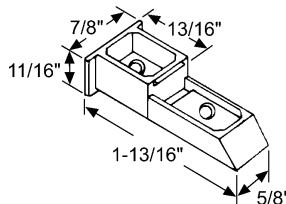

60-617

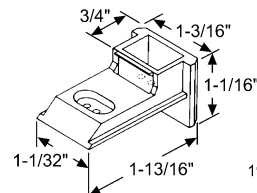

60-644

Black

Storm Weather

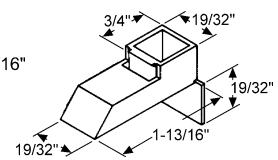

60-656

Howard

TOLL FREE 800-352-0800

2003, SBI®

strybug

60 SERIES BALANCE ACCESSORIES

PLASTIC TOP SASH GUIDES - BY HEIGHT

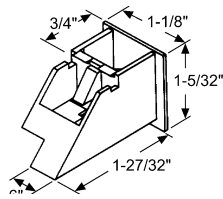

60-649A Black
RH & LH Set

Peco

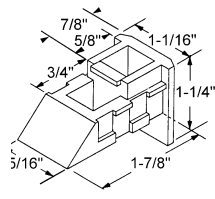

60-660 Black

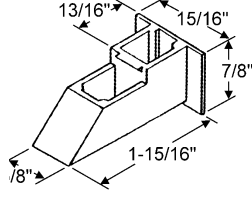

900-16814 Natural Color

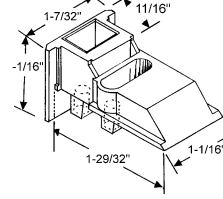

900-15755BA Black
Sold in Sets Only

Stormweather

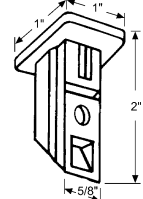

60-582

Seasonal

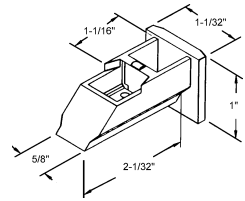

900-15245
White (Original color gray)

Amacor

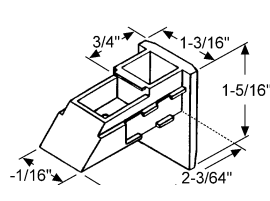

60-650 Black

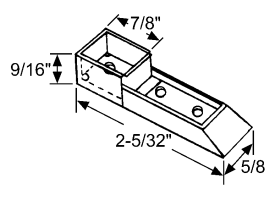

60-603

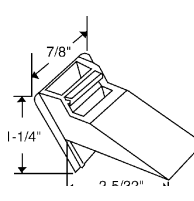

60-610 Black

Acorn

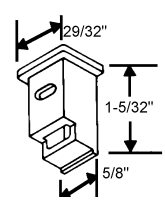

70-634 Black

Gallatin/Gapco

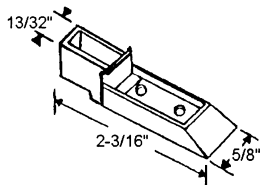

60-668

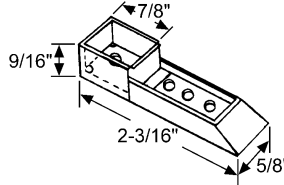

60-669

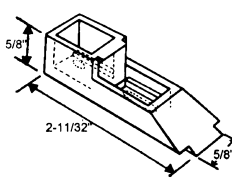

60-623

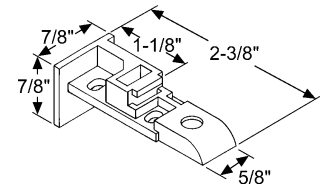

60-684LH Opposite
60-684RH Shown
White

SASH GUIDE SETS

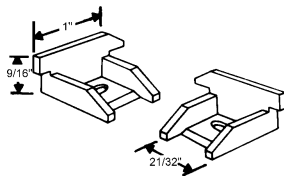

60-619

Crossly

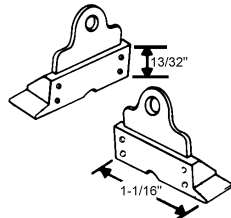

60-620

Capitol

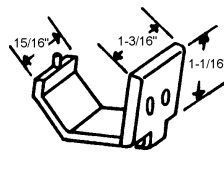

900-9250 Bronze
900-9250W White

METAL SASH GUIDES

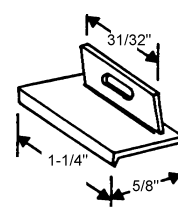

60-615 Not Available
Use **60-665**

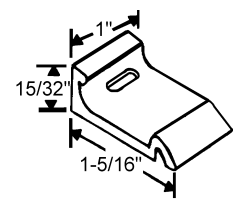

60-665

Crossly

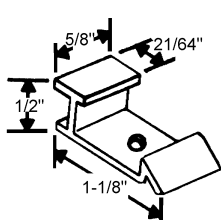

60-609

Howard

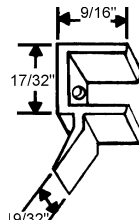

60-607

Capitol

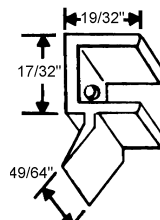

60-608

Capitol

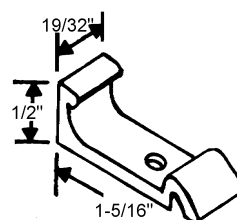

60-611

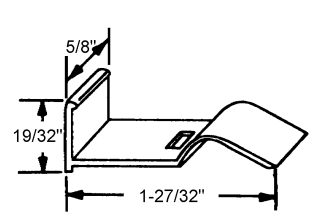

60-663

Capitol

60 SERIES BALANCE ACCESSORIES

METAL SASH GUIDES

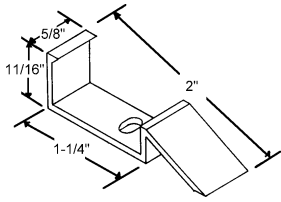

900-10396

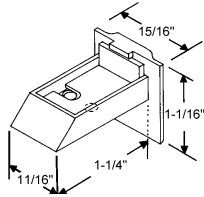

900-15838
Black Plastic w/ Metal
Reinforcing Plate

TAKE OUT CLIP

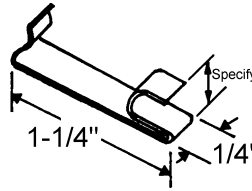

60-700 1/4"
60-708 5/16"

PLASTIC TAKE OUT CLIPS

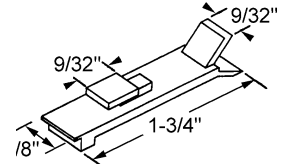

60-662

Pan Am

SQUARE GUIDE

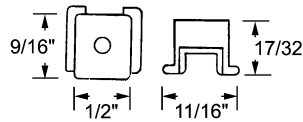

60-614

WT Industries

FRAME GUIDE

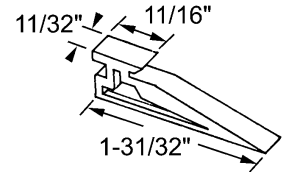

60-701

Ida

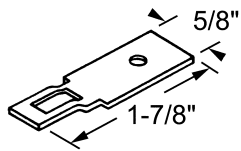

60-704

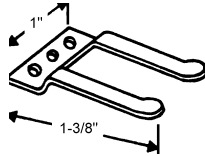

60-706

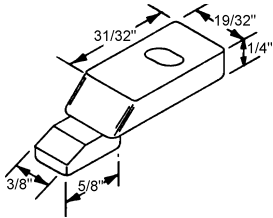

900-6758
Silverline

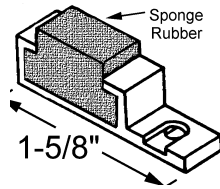

60-801

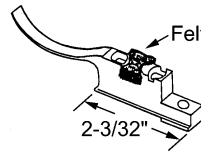

60-702

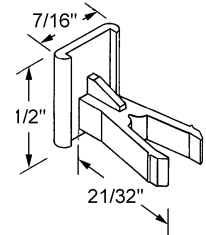

900-2480
Howmet

SASH CENTERING GUIDE

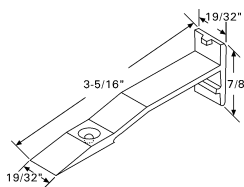

900-17308
Weathervane

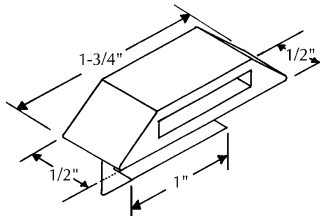

900-17243 Nylon

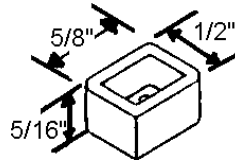

900-13360
SWS

FIXED SASH SPACER

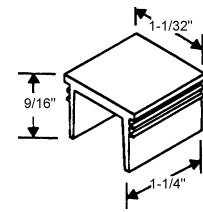

60-802

SASH STOPS

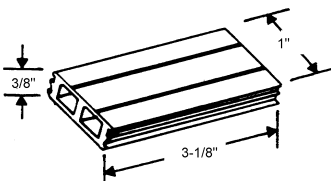

60-705
White Rubber
Capitol

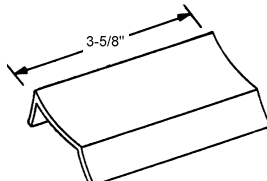

60-709

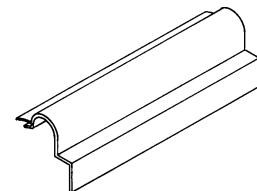

900-18768
Seasonall

60A AND 60AX SERIES - THE INVISIBLE BALANCE

The Invisible Balance has been used for over 25 years primarily for wood windows. They are an excellent choice for historic window renovations, eliminating exposed hardware and maintaining the original window appearance. This product is the favorite of the custom millwork industry when jambliner aesthetics are not acceptable.

ORDERING INFORMATION

- 1) Measure metal channel length.
- 2) Check number stamped on channel e.g. 101 or 101A or 101AX etc...
- 3) Select our corresponding part numbers from the chart on following page and order accordingly.
- 4) Additional cord lengths are available: For 10" add 'A' after part number, 5" add 'B' and 8" add 'C'. Contact your Account Manager for other variations.

NOTE: If replacing your old wire cable balances to our new style, please request installation instructions. If you have any unusual number/letter variations that are not shown in the chart, please consult your representative to be sure that your order will be filled correctly.

NOTE: With the 60A and 60AX Series take out system, the sash balance becomes part of the sash. Therefore when calculating sash weights, you must add the physical balance weight to the sash weights.

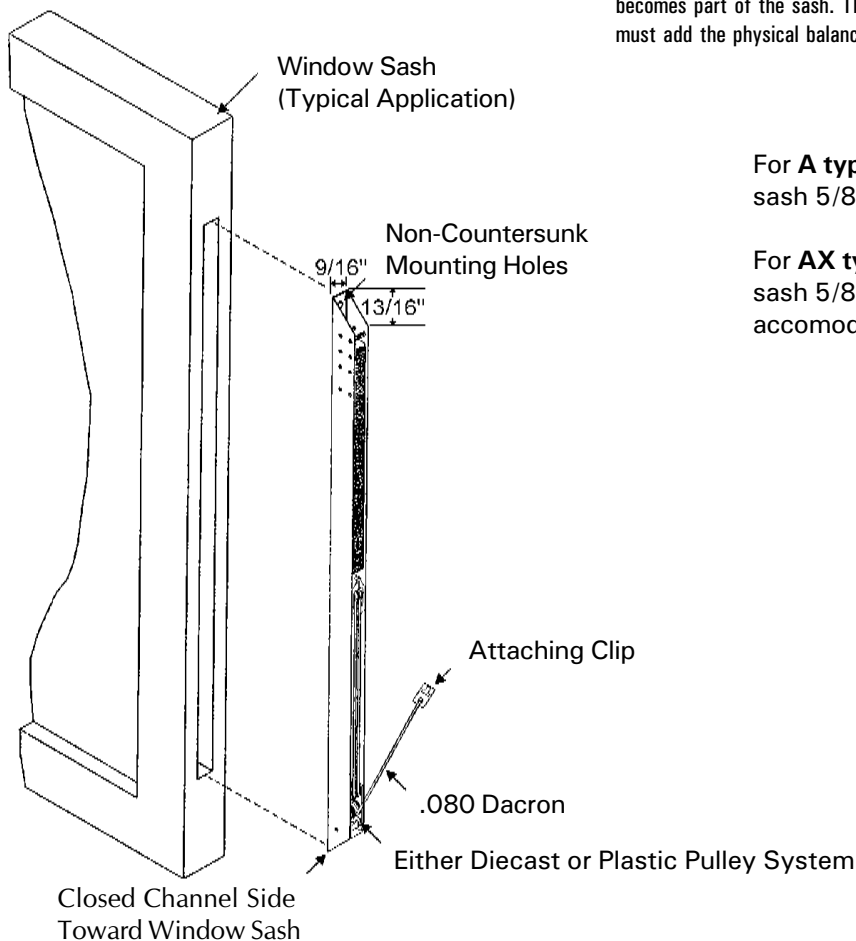

For **A type balance** make plough in sash 5/8" wide X 1" deep.

For **AX type balance** make plough in sash 5/8" wide X 1-1/8" deep to accommodate double spring.

Refer to Chart on Following Page.

SERIES A/AX BALANCE INSTALLATION

- Both 'A' & 'AX' balances are designed to counterbalance certain weights, regardless of the thickness of the sash. Do not overload.
- For odd heights glass use the next smaller balance.
- When ploughing for over 36" glass height start at bottom of each sash as always and make groove the same length as you do for 36" glass leaving extra wood at top of stiles.

60A AND 60AX SERIES - THE INVISIBLE BALANCE

Channel Height

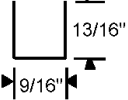

Channel Width

9/16" x 13/16"



"A" and "AX" Old style had wire cable. New style uses dacron cord.

"A" Type is Single Spring
"AX" Type is Double Spring

Old style is slotted
New style is not



Bottom View

End Brackets



900-21263

-10
STANDARD (Preferred)

Brass Fitting with Round Screw Hole

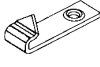

60-518HD

-1



900-17773

Accessory Clips

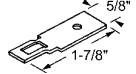

60-704



60-704M

Example Ordering Chart

LENGTH OF METAL CHANNEL	NUMBER STAMPED ON BALANCE	OUR PART NUMBER	END BRACKET	CORD LENGTH	COMPLETE PART NUMBER
13-1/2"	101	60-A101	Standard	Standard	60-A101
13-1/2"	101	60-A101	1	Standard	60-A101-1
13-1/2"	101	60-A101	10	Standard	60-A101-10
13-1/2"	101	60-A101	10	+ 10"	60-A101-10A
13-1/2"	101	60-A101	10	+ 5"	60-A101-10B
13-1/2"	101	60-A101	10	+ 8"	60-A101-10C

"A" TYPE (Single Spring)

"AX" TYPE (Double Spring)

GLASS HEIGHT	LENGTH OF METAL CHANNEL	BALANCE NUMBER	SASH WEIGHT PER PAIR	STANDARD CORD LENGTH	OUR PART NUMBER	GLASS HEIGHT	LENGTH OF METAL CHANNEL	BALANCE NUMBER	SASH WEIGHT PER PAIR	STANDARD CORD LENGTH	OUR PART NUMBER
12"	13-1/2"	101	5-7 lbs.	31"	60-A101	12"	13-1/2"	101AX	11-16 lbs.	31"	60-AX101
12"	13-1/2"	102	7-11 lbs.	31"	60-A102	12"	13-1/2"	102AX	16-24 lbs.	31"	60-AX102
14"	15-1/2"	111	5-8 lbs.	33"	60-A111	14"	15-1/2"	111AX	11-16 lbs.	33"	60-AX111
14"	15-1/2"	112	8-11 lbs.	33"	60-A112	14"	15-1/2"	112AX	16-25 lbs.	33"	60-AX112
16"	17-1/2"	121	5-9 lbs.	35"	60-A121	16"	17-1/2"	121AX	12-19 lbs.	35"	60-AX121
16"	17-1/2"	122	9-12 lbs.	35"	60-A122	16"	17-1/2"	122AX	19-26 lbs.	35"	60-AX122
18"	19-1/2"	131	5-9 lbs.	37"	60-A131	18"	19-1/2"	131AX	13-19 lbs.	37"	60-AX131
18"	19-1/2"	132	9-13 lbs.	37"	60-A132	18"	19-1/2"	132AX	19-26 lbs.	37"	60-AX132
20"	21-1/2"	141	5-9 lbs.	39"	60-A141	20"	21-1/2"	141AX	14-20 lbs.	39"	60-AX141
20"	21-1/2"	142	9-12 lbs.	39"	60-A142	20"	21-1/2"	142AX	20-26 lbs.	39"	60-AX142
20"	21-1/2"	143	12-14 lbs.	39"	60-A143	20"	21-1/2"	143AX	26-30 lbs.	39"	60-AX143
22"	23-1/2"	151	6-10 lbs.	41"	60-A151	22"	23-1/2"	151AX	15-20 lbs.	41"	60-AX151
22"	23-1/2"	152	10-12 lbs.	41"	60-A152	22"	23-1/2"	152AX	20-26 lbs.	41"	60-AX152
22"	23-1/2"	153	12-15 lbs.	41"	60-A153	22"	23-1/2"	153AX	26-32 lbs.	41"	60-AX153
24"	25-1/2"	161	6-10 lbs.	43"	60-A161	24"	25-1/2"	161AX	18-23 lbs.	43"	60-AX161
24"	25-1/2"	162	10-14 lbs.	43"	60-A162	24"	25-1/2"	162AX	23-28 lbs.	43"	60-AX162
24"	25-1/2"	163	14-18 lbs.	43"	60-A163	24"	25-1/2"	163AX	28-34 lbs.	43"	60-AX163
26"	27-1/2"	171	6-10 lbs.	45"	60-A171	26"	27-1/2"	171AX	18-23 lbs.	45"	60-AX171
26"	27-1/2"	172	10-14 lbs.	45"	60-A172	26"	27-1/2"	172AX	23-28 lbs.	45"	60-AX172
26"	27-1/2"	173	14-18 lbs.	45"	60-A173	26"	27-1/2"	173AX	28-34 lbs.	45"	60-AX173
28"	29-1/2"	181	7-12 lbs.	47"	60-A181	28"	29-1/2"	181AX	18-23 lbs.	47"	60-AX181
28"	29-1/2"	182	12-16 lbs.	47"	60-A182	28"	29-1/2"	182AX	20-25 lbs.	47"	60-AX182
28"	29-1/2"	183	16-20 lbs.	47"	60-A183	28"	29-1/2"	183AX	25-32 lbs.	47"	60-AX183
30"	31-1/2"	191	7-12 lbs.	49"	60-A191	28"	29-1/2"	184AX	32-38 lbs.	47"	60-AX184
30"	31-1/2"	192	12-16 lbs.	49"	60-A192	30"	31-1/2"	191AX	20-25 lbs.	49"	60-AX191
30"	31-1/2"	193	16-20 lbs.	49"	60-A193	30"	31-1/2"	192AX	25-32 lbs.	49"	60-AX192
32"	33-1/2"	201	8-14 lbs.	51"	60-A201	30"	31-1/2"	193AX	32-38 lbs.	49"	60-AX193
32"	33-1/2"	202	14-18 lbs.	51"	60-A202	30"	31-1/2"	194AX	38-42 lbs.	49"	60-AX194
32"	33-1/2"	203	18-22 lbs.	51"	60-A203	32"	33-1/2"	201AX	22-28 lbs.	51"	60-AX201
34"	35-1/2"	211	8-14 lbs.	53"	60-A211	32"	33-1/2"	202AX	28-34 lbs.	51"	60-AX202
34"	35-1/2"	212	14-18 lbs.	53"	60-A212	32"	33-1/2"	203AX	34-40 lbs.	51"	60-AX203
34"	35-1/2"	213	18-22 lbs.	53"	60-A213	32"	33-1/2"	204AX	40-44 lbs.	51"	60-AX204
36"	37-1/2"	221	8-15 lbs.	55"	60-A221	34"	35-1/2"	211AX	22-28 lbs.	53"	60-AX211
36"	37-1/2"	222	15-20 lbs.	55"	60-A222	34"	35-1/2"	212AX	28-34 lbs.	53"	60-AX212
36"	37-1/2"	223	20-24 lbs.	55"	60-A223	34"	35-1/2"	213AX	34-40 lbs.	53"	60-AX213
38"	37-1/2"	231	8-15 lbs.	57"	60-A231	34"	35-1/2"	214AX	40-44 lbs.	53"	60-AX214
38"	37-1/2"	232	15-20 lbs.	57"	60-A232	36"	37-1/2"	221AX	24-30 lbs.	55"	60-AX221
38"	37-1/2"	233	20-24 lbs.	57"	60-A233	36"	37-1/2"	222AX	30-36 lbs.	55"	60-AX222
40"	37-1/2"	241	8-15 lbs.	59"	60-A241	36"	37-1/2"	223AX	36-42 lbs.	55"	60-AX223
40"	37-1/2"	242	15-20 lbs.	59"	60-A242	36"	37-1/2"	224AX	42-48 lbs.	55"	60-AX224
40"	37-1/2"	243	20-24 lbs.	59"	60-A243	38"	37-1/2"	231AX	24-30 lbs.	57"	60-AX231
42"	37-1/2"	251	8-15 lbs.	61"	60-A251	38"	37-1/2"	232AX	30-36 lbs.	57"	60-AX232
42"	37-1/2"	252	15-20 lbs.	61"	60-A252	38"	37-1/2"	233AX	36-42 lbs.	57"	60-AX233
42"	37-1/2"	253	20-24 lbs.	61"	60-A253	38"	37-1/2"	234AX	42-48 lbs.	57"	60-AX234
						40"	37-1/2"	241AX	24-30 lbs.	59"	60-AX241
						40"	37-1/2"	242AX	30-36 lbs.	59"	60-AX242
						40"	37-1/2"	243AX	36-42 lbs.	59"	60-AX243
						40"	37-1/2"	244AX	42-48 lbs.	59"	60-AX244
						42"	37-1/2"	251AX	24-30 lbs.	61"	60-AX251
						42"	37-1/2"	252AX	30-36 lbs.	61"	60-AX252
						42"	37-1/2"	253AX	36-42 lbs.	61"	60-AX253
						42"	37-1/2"	254AX	42-48 lbs.	61"	60-AX254

NOTE: Whenever you add cord length to standard length you reduce the sash weight capacity and forfeit the warranty.

NOTE: Numbers stamped on balances may be the same—single spring designated by "A"—double spring designated by "AX"

NOTE: When determining sash weight, you need to include the weight of the balances. E.G. Sash weighs 20 lbs. (2) balances weigh 3 lbs. Total sash weight is 23 lbs.

TOLL FREE 800-352-0800

2003, SBI®

strybuc

13

rev. 10/18/04

Return to Table of Contents

60B SERIES OVERHEAD CHANNEL BALANCES

Bantam Type

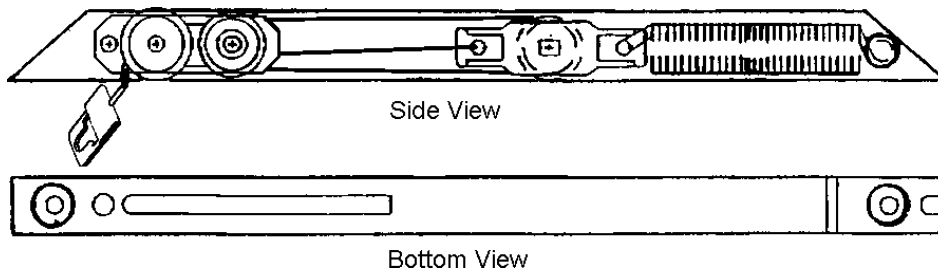

ORDERING INFORMATION

- 1) Measure metal channel length.
- 2) Check number stamped on channel e.g.. 102, 111, 121 etc... (Disregard any small letter that may be stamped after the number e.g. a, b, c etc...)
- 3) Select our corresponding part numbers from the chart below and order accordingly

GENERAL INFORMATION

- 1) All Bantam type balances will be supplied with the standard clip shown.
- 2) If you have any other number/letter combination on your balance, consult your representative to insure that your order is filled correctly.

LENGTH OF METAL CHANNEL	NUMBER STAMPED ON BALANCE	SASH WEIGHT LBS.	OUR PART NUMBER	LENGTH OF METAL CHANNEL	NUMBER STAMPED ON BALANCE	SASH WEIGHT LBS.	OUR PART NUMBER
12-1/2"	101B	5-7	60-B12.5-1	24-1/2"	162B	10-14	60-B24.5-2
12-1/2"	102B	7-11	60-B12.5-2	24-1/2"	163B	14-16	60-B24.5-3
12-1/2"	102BHD	11-13	60-B12.5-3	24-1/2"	163BHD	18-24	60-B24.5-4
14-1/2"	111B	5-8	60-B14.5-1	28-1/2"	181B	7-12	60-B28.5-1
14-1/2"	112B	8-11	60-B14.5-2	28-1/2"	182B	12-16	60-B28.5-2
14-1/2"	112BHD	11-16	60-B14.5-3	28-1/2"	183B	16-20	60-B28.5-3
16-1/2"	121B	5-9	60-B16.5-1	28-1/2"	183BHD	20-30	60-B28.5-4
16-1/2"	122B	9-12	60-B16.5-2	32-1/2"	201B	8-14	60-B32.5-1
16-1/2"	122BHD	12-16	60-B16.5-3	32-1/2"	202B	14-18	60-B32.5-2
20-1/2"	141B	5-9	60-B20.5-1	32-1/2"	203B	18-22	60-B32.5-3
20-1/2"	142B	9-12	60-B20.5-2	32-1/2"	203BHD	22-30	60-B32.5-4
20-1/2"	143B	12-14	60-B20.5-3	36-1/2"	221B	8-15	60-B36.5-1
20-1/2"	142BHD	14-20	60-B20.5-4	36-1/2"	222B	15-20	60-B36.5-2
24-1/2"	161B	6-10	60-B24.5-1	36-1/2"	223B	20-24	60-B36.5-3
				36-1/2"	223BHD	24-34	60-B36.5-4



Tension Adjustment Screw

Ordering Information

- 1) Measure metal channel length (Do not include plastic ends.)
- 2) Check number stamped on channel: e.g., 20-2, 30-5 etc.
- 3) Select our corresponding part number from the chart below.
- 4) To identify the top and bottom ends to be attached, refer to pages 7 & 8.

General Information

- 1) Balance prices do not include attached bracket costs.
- 2) Note that this balance has a tension adjustment screw and the top spring anchor is directly attached to the back wall of the balance channel with a porcupine pinning effect.
- 3) For special channel lengths, please consult your representative.

Note: Top & bottom balance ends must be ordered separately. If you want ends attached, add the letter "A" to the suffix of the part number when ordering.

LENGTH OF METAL CHANNEL	NUMBER STAMPED ON BALANCE	SASH WEIGHT CAPACITY	OUR PART NUMBER	LENGTH OF METAL CHANNEL	NUMBER STAMPED ON BALANCE	SASH WEIGHT CAPACITY	OUR PART NUMBER	LENGTH OF METAL CHANNEL	NUMBER STAMPED ON BALANCE	SASH WEIGHT CAPACITY	OUR PART NUMBER
9"	10-0	2 TO 3 LBS.	61-100	16"	15-9	23 TO 26 LBS.	61-159	23"	22-1	5 TO 8 LBS.	61-221
9"	10-1	3 TO 5 LBS.	61-101	17"	16-1	5 TO 8 LBS.	61-161	23"	22-2	9 TO 12 LBS.	61-222
9"	10-2	6 TO 8 LBS.	61-102	17"	16-2	9 TO 12 LBS.	61-162	23"	22-3	13 TO 19 LBS.	61-223
9"	10-3	9 TO 10 LBS.	61-103	17"	16-3	11 TO 14 LBS.	61-163	23"	22-4	20 TO 23 LBS.	61-224
9"	10-4	11 TO 13 LBS.	61-104	17"	16-4	13 TO 19 LBS.	61-164	23"	22-5	24 TO 27 LBS.	61-225
9"	10-5	14 TO 15 LBS.	61-105	17"	16-5	20 TO 23 LBS.	61-165	23"	22-9	28 TO 30 LBS.	61-229
9"	10-9	16 TO 18 LBS.	61-109	17"	16-9	24 TO 26 LBS.	61-169	24"	23-1	5 TO 9 LBS.	61-231
10"	11-1	3 TO 5 LBS.	61-111	18"	17-1	5 TO 8 LBS.	61-171	24"	23-2	10 TO 15 LBS.	61-232
10"	11-2	6 TO 8 LBS.	61-112	18"	17-2	9 TO 12 LBS.	61-172	24"	23-3	16 TO 18 LBS.	61-233
10"	11-3	9 TO 10 LBS.	61-113	18"	17-3	10 TO 14 LBS.	61-173	24"	23-4	19 TO 22 LBS.	61-234
10"	11-4	11 TO 12 LBS.	61-114	18"	17-4	13 TO 17 LBS.	61-174	24"	23-5	23 TO 27 LBS.	61-235
10"	11-5	13 TO 15 LBS.	61-115	18"	17-5	18 TO 20 LBS.	61-175	24"	23-9	28 TO 30 LBS.	61-239
10"	11-9	16 TO 18 LBS.	61-119	18"	17-9	21 TO 26 LBS.	61-179	25"	24-1	5 TO 9 LBS.	61-241
13"	12-1	3 TO 6 LBS.	61-121	19"	18-1	5 TO 8 LBS.	61-181	25"	24-2	10 TO 15 LBS.	61-242
13"	12-2	7 TO 9 LBS.	61-122	19"	18-2	9 TO 12 LBS.	61-182	25"	24-3	15 TO 19 LBS.	61-243
13"	12-3	8 TO 11 LBS.	61-123	19"	18-3	11 TO 14 LBS.	61-183	25"	24-4	20 TO 24 LBS.	61-244
13"	12-4	10 TO 12 LBS.	61-124	19"	18-4	13 TO 17 LBS.	61-184	25"	24-5	25 TO 30 LBS.	61-245
13"	12-5	13 TO 15 LBS.	61-125	19"	18-5	18 TO 24 LBS.	61-185	25"	24-9	31 TO 34 LBS.	61-249
13"	12-6	16 TO 19 LBS.	61-126	19"	18-6	25 TO 27 LBS.	61-186	26"	25-1	5 TO 9 LBS.	61-251
13"	12-9	20 TO 22 LBS.	61-129	19"	18-9	28 TO 30 LBS.	61-189	26"	25-2	10 TO 15 LBS.	61-252
14"	13-1	3 TO 6 LBS.	61-131	20"	19-1	5 TO 8 LBS.	61-191	26"	25-3	16 TO 19 LBS.	61-253
14"	13-2	7 TO 9 LBS.	61-132	20"	19-2	9 TO 12 LBS.	61-192	26"	25-4	20 TO 25 LBS.	61-254
14"	13-3	8 TO 11 LBS.	61-133	20"	19-3	12 TO 16 LBS.	61-193	26"	25-5	26 TO 31 LBS.	61-255
14"	13-4	10 TO 12 LBS.	61-134	20"	19-4	13 TO 17 LBS.	61-194	26"	25-9	32 TO 34 LBS.	61-259
14"	13-5	13 TO 17 LBS.	61-135	20"	19-5	18 TO 21 LBS.	61-195	27"	26-1	5 TO 9 LBS.	61-261
14"	13-9	18 TO 22 LBS.	61-139	20"	19-6	22 TO 26 LBS.	61-196	27"	26-2	10 TO 13 LBS.	61-262
15"	14-1	4 TO 6 LBS.	61-141	20"	19-9	27 TO 30 LBS.	61-199	27"	26-3	14 TO 19 LBS.	61-263
15"	14-2	7 TO 10 LBS.	61-142	21"	20-1	5 TO 8 LBS.	61-201	27"	26-4	20 TO 26 LBS.	61-264
15"	14-3	8 TO 12 LBS.	61-143	21"	20-2	9 TO 12 LBS.	61-202	27"	26-5	27 TO 29 LBS.	61-265
15"	14-4	11 TO 13 LBS.	61-144	21"	20-3	13 TO 15 LBS.	61-203	27"	26-6	30 TO 32 LBS.	61-266
15"	14-5	14 TO 18 LBS.	61-145	21"	20-4	16 TO 23 LBS.	61-204	27"	26-9	33 TO 34 LBS.	61-269
15"	14-6	19 TO 23 LBS.	61-146	21"	20-5	24 TO 26 LBS.	61-205	28"	27-1	5 TO 9 LBS.	61-271
15"	14-9	24 TO 26 LBS.	61-149	21"	20-9	27 TO 30 LBS.	61-209	28"	27-2	10 TO 13 LBS.	61-272
16"	15-1	4 TO 6 LBS.	61-151	22"	21-1	5 TO 8 LBS.	61-211	28"	27-3	14 TO 19 LBS.	61-273
16"	15-2	7 TO 10 LBS.	61-152	22"	21-2	9 TO 12 LBS.	61-212	28"	27-4	20 TO 26 LBS.	61-274
16"	15-3	10 TO 12 LBS.	61-153	22"	21-3	13 TO 15 LBS.	61-213	28"	27-5	27 TO 29 LBS.	61-275
16"	15-4	11 TO 13 LBS.	61-154	22"	21-4	16 TO 23 LBS.	61-214	28"	27-6	30 TO 33 LBS.	61-276
16"	15-5	14 TO 17 LBS.	61-155	22"	21-5	24 TO 26 LBS.	61-215	28"	27-9	34 TO 36 LBS.	61-279
16"	15-6	18 TO 22 LBS.	61-156	22"	21-9	27 TO 30 LBS.	61-219	29"	28-1	7 TO 12 LBS.	61-281

Chart Continued Next Page

1/2" CHANNEL BALANCE WITH HEMMED EDGE - 61 SERIES

SASH SUPPORT SYSTEMS

LENGTH OF CHANNEL	NUMBER OF METALSTAMPED CHANNEL	SASH BALANCE ONWEIGHT CAPACITY	OUR PART NUMBER	LENGTH OF CHANNEL	NUMBER OF METALSTAMPED CHANNEL	SASH BALANCE ONWEIGHT CAPACITY	OUR PART NUMBER	LENGTH OF CHANNEL	NUMBER OF METALSTAMPED CHANNEL	SASH BALANCE ONWEIGHT CAPACITY	OUR PART NUMBER
29"	28-2	13 TO 16 LBS.	61-282	37"	36-5	31 TO 35 LBS.	61-365	46"	45-3	20 TO 24 LBS.	61-453
29"	28-3	17 TO 23 LBS.	61-283	37"	36-9	36 TO 40 LBS.	61-369	46"	45-4	25 TO 30 LBS.	61-454
29"	28-4	24 TO 28 LBS.	61-284	38"	37-1	8 TO 13 LBS.	61-371	46"	45-5	31 TO 37 LBS.	61-455
29"	28-5	29 TO 32 LBS.	61-285	38"	37-2	14 TO 18 LBS.	61-372	46"	45-9	38 TO 42 LBS.	61-459
29"	28-6	33 TO 35 LBS.	61-286	38"	37-3	19 TO 23 LBS.	61-373	47"	46-1	9 TO 14 LBS.	61-461
29"	28-9	36 TO 38 LBS.	61-289	38"	37-4	24 TO 32 LBS.	61-374	47"	46-2	15 TO 19 LBS.	61-462
30"	29-1	7 TO 12 LBS.	61-291	38"	37-5	33 TO 36 LBS.	61-375	47"	46-3	20 TO 24 LBS.	61-463
30"	29-2	13 TO 16 LBS.	61-292	38"	37-9	37 TO 40 LBS.	61-379	47"	46-4	25 TO 30 LBS.	61-464
30"	29-3	17 TO 23 LBS.	61-293	39"	38-1	9 TO 14 LBS.	61-381	47"	46-5	31 TO 37 LBS.	61-465
30"	29-4	24 TO 28 LBS.	61-294	39"	38-2	15 TO 19 LBS.	61-382	47"	46-9	38 TO 44 LBS.	61-469
30"	29-5	29 TO 32 LBS.	61-295	39"	38-3	20 TO 24 LBS.	61-383	48"	47-1	9 TO 14 LBS.	61-471
30"	29-5	29 TO 32 LBS.	61-295	39"	38-4	25 TO 30 LBS.	61-384	48"	47-2	15 TO 19 LBS.	61-472
30"	29-6	33 TO 35 LBS.	61-296	39"	38-5	31 TO 36 LBS.	61-385	48"	47-3	20 TO 24 LBS.	61-473
30"	29-9	36 TO 38 LBS.	61-299	39"	38-9	37 TO 40 LBS.	61-389	48"	47-4	25 TO 30 LBS.	61-474
31"	30-1	7 TO 12 LBS.	61-301	40"	39-1	9 TO 14 LBS.	61-391	48"	47-5	31 TO 37 LBS.	61-475
31"	30-2	13 TO 16 LBS.	61-302	40"	39-2	15 TO 19 LBS.	61-392	48"	47-9	38 TO 44 LBS.	61-479
31"	30-3	17 TO 23 LBS.	61-303	40"	39-3	20 TO 24 LBS.	61-393	49"	48-1	9 TO 14 LBS.	61-481
31"	30-4	24 TO 28 LBS.	61-304	40"	39-4	25 TO 30 LBS.	61-394	49"	48-2	15 TO 19 LBS.	61-482
31"	30-5	29 TO 32 LBS.	61-305	40"	39-5	31 TO 36 LBS.	61-395	49"	48-3	20 TO 24 LBS.	61-483
31"	30-6	33 TO 35 LBS.	61-306	40"	39-9	37 TO 40 LBS.	61-399	49"	48-4	25 TO 32 LBS.	61-484
31"	30-9	36 TO 38 LBS.	61-309	41"	40-1	9 TO 14 LBS.	61-401	49"	48-5	33 TO 37 LBS.	61-485
32"	31-1	7 TO 12 LBS.	61-311	41"	40-2	15 TO 19 LBS.	61-402	49"	48-9	38 TO 44 LBS.	61-489
32"	31-2	13 TO 16 LBS.	61-312	41"	40-3	20 TO 23 LBS.	61-403	50"	49-1	9 TO 14 LBS.	61-491
32"	31-3	17 TO 23 LBS.	61-313	41"	40-4	24 TO 30 LBS.	61-404	50"	49-2	15 TO 19 LBS.	61-492
32"	31-4	24 TO 28 LBS.	61-314	41"	40-5	31 TO 36 LBS.	61-405	50"	49-3	20 TO 24 LBS.	61-493
32"	31-5	29 TO 32 LBS.	61-315	41"	40-9	37 TO 42 LBS.	61-409	50"	49-4	25 TO 32 LBS.	61-494
32"	31-6	33 TO 35 LBS.	61-316	42"	41-1	9 TO 14 LBS.	61-411	50"	49-5	33 TO 37 LBS.	61-495
32"	31-9	36 TO 38 LBS.	61-319	42"	41-2	15 TO 19 LBS.	61-412	50"	49-9	38 TO 44 LBS.	61-499
33"	32-1	8 TO 13 LBS.	61-321	42"	41-3	20 TO 24 LBS.	61-413	51"	50-1	9 TO 14 LBS.	61-501
33"	32-2	14 TO 18 LBS.	61-322	42"	41-4	25 TO 30 LBS.	61-414	51"	50-2	15 TO 19 LBS.	61-502
33"	32-3	19 TO 23 LBS.	61-323	42"	41-5	31 TO 36 LBS.	61-415	51"	50-3	20 TO 24 LBS.	61-503
33"	32-4	24 TO 28 LBS.	61-324	42"	41-9	37 TO 42 LBS.	61-419	51"	50-4	25 TO 32 LBS.	61-504
33"	32-5	29 TO 32 LBS.	61-325	43"	42-1	9 TO 14 LBS.	61-421	51"	50-5	33 TO 37 LBS.	61-505
33"	32-6	32 TO 33 LBS.	61-326	43"	42-2	15 TO 19 LBS.	61-422	51"	50-9	38 TO 44 LBS.	61-509
33"	32-9	34 TO 38 LBS.	61-329	43"	42-3	20 TO 24 LBS.	61-423	52"	51-1	9 TO 14 LBS.	61-511
34"	33-1	8 TO 13 LBS.	61-331	43"	42-4	25 TO 30 LBS.	61-424	52"	51-2	15 TO 19 LBS.	61-512
34"	33-2	14 TO 18 LBS.	61-332	43"	42-5	31 TO 36 LBS.	61-425	52"	51-3	20 TO 24 LBS.	61-513
34"	33-3	19 TO 23 LBS.	61-333	43"	42-9	37 TO 42 LBS.	61-429	52"	51-4	25 TO 32 LBS.	61-514
34"	33-4	24 TO 28 LBS.	61-334	44"	43-1	9 TO 14 LBS.	61-431	52"	51-5	33 TO 37 LBS.	61-515
34"	33-5	29 TO 32 LBS.	61-335	44"	43-2	15 TO 19 LBS.	61-432	52"	51-9	38 TO 44 LBS.	61-519
34"	33-6	33 TO 35 LBS.	61-336	44"	43-3	20 TO 24 LBS.	61-433	53"	52-1	9 TO 14 LBS.	61-521
34"	33-9	36 TO 38 LBS.	61-339	44"	43-4	25 TO 30 LBS.	61-434	53"	52-2	15 TO 19 LBS.	61-522
35"	34-1	8 TO 13 LBS.	61-341	44"	43-5	31 TO 36 LBS.	61-435	53"	52-3	20 TO 24 LBS.	61-523
35"	34-2	14 TO 18 LBS.	61-342	44"	43-9	37 TO 42 LBS.	61-439	53"	52-4	25 TO 32 LBS.	61-524
35"	34-3	19 TO 23 LBS.	61-343	45"	44-1	9 TO 14 LBS.	61-441	53"	52-5	33 TO 37 LBS.	61-525
35"	34-4	24 TO 30 LBS.	61-344	45"	44-2	15 TO 19 LBS.	61-442	53"	52-9	38 TO 44 LBS.	61-529
35"	34-5	31 TO 34 LBS.	61-345	45"	44-3	20 TO 24 LBS.	61-443	54"	53-1	9 TO 14 LBS.	61-531
35"	34-9	35 TO 38 LBS.	61-349	45"	44-4	25 TO 30 LBS.	61-444	54"	53-2	15 TO 19 LBS.	61-532
36"	35-1	8 TO 13 LBS.	61-351	45"	44-5	31 TO 36 LBS.	61-445	54"	53-3	20 TO 25 LBS.	61-533
36"	35-2	14 TO 18 LBS.	61-352	45"	44-9	37 TO 42 LBS.	61-449	54"	53-4	26 TO 34 LBS.	61-534
36"	35-3	19 TO 23 LBS.	61-353	45"	44-1	9 TO 14 LBS.	61-441	54"	53-5	35 TO 39 LBS.	61-535
36"	35-4	24 TO 30 LBS.	61-354	45"	44-2	15 TO 19 LBS.	61-442	54"	53-9	40 TO 44 LBS.	61-539
36"	35-5	31 TO 35 LBS.	61-355	45"	44-3	20 TO 24 LBS.	61-443	55"	54-3	20 TO 25 LBS.	61-543
36"	35-9	36 TO 40 LBS.	61-359	45"	44-4	25 TO 30 LBS.	61-444	55"	54-5	35 TO 39 LBS.	61-545
37"	36-1	8 TO 13 LBS.	61-361	45"	44-5	31 TO 36 LBS.	61-445	55"	54-9	35 TO 48 LBS.	61-549
37"	36-2	14 TO 18 LBS.	61-362	45"	44-9	37 TO 42 LBS.	61-449	57"	56-5	35 TO 39 LBS.	61-565
37"	36-3	19 TO 23 LBS.	61-363	46"	45-1	9 TO 14 LBS.	61-451	59"	58-3	20 TO 25 LBS.	61-583
37"	36-4	24 TO 30 LBS.	61-364	46"	45-2	15 TO 19 LBS.	61-452				

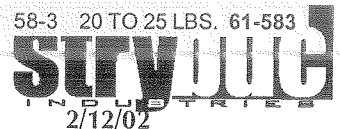

Top Brackets

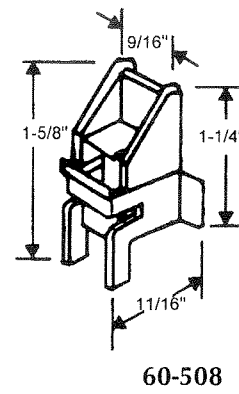
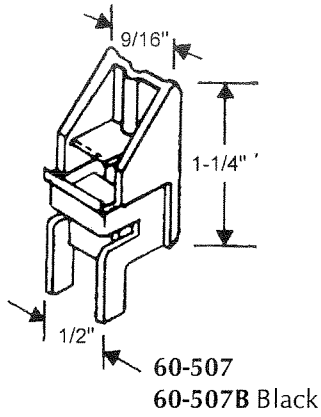

Bottom Brackets

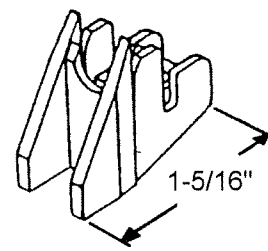
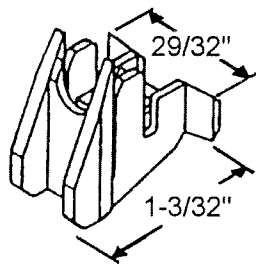
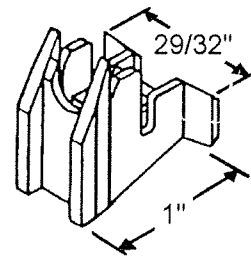
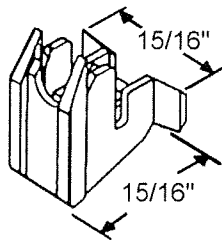
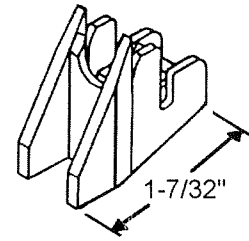
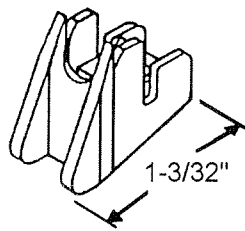
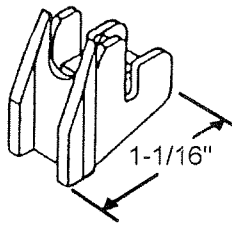

64 SERIES CHANNEL BALANCES

3/8" CHANNEL BALANCE

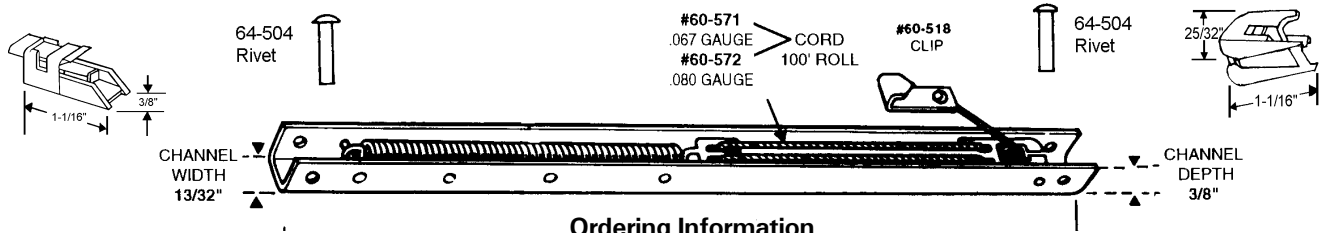

Ordering Information

- 1) Measure metal channel length (Do not include plastic ends.)
- 2) Check number stamped on channel: e.g., 19A, 22B, 28C, etc.
- 3) Select our corresponding part number from the chart below.
- 4) To identify the top and bottom ends to be attached, see bottom of this page

Note: Top & bottom balance ends must be ordered separately. If you want ends attached, add the letter "A" to the suffix of the part number when ordering.

Popular in Southeast; primarily used by Binnings and Moss

Length of Metal Channel	Number Stamped on Balance	Our Part Number	Number Stamped on Balance	Our Part Number	Number Stamped on Balance	Our Part Number	Length of Metal Channel
10"	9A	64-091	9B	64-092	9C	64-093	10"
11"	10A	64-101	10B	64-102	10C	64-103	11"
12"	11A	64-111	11B	64-112	11C	64-113	12"
13"	12A	64-121	12B	64-122	12C	64-123	13"
14"	13A	64-131	13B	64-132	13C	64-133	14"
15"	14A	64-141	14B	64-142	14C	64-143	15"
16"	15A	64-151	15B	64-152	15C	64-153	16"
17"	16A	64-161	16B	64-162	16C	64-163	17"
18"	17A	64-171	17B	64-172	17C	64-173	18"
19"	18A	64-181	18B	64-182	18C	64-183	19"
20"	19A	64-191	19B	64-192	19C	64-193	20"
21"	20A	64-201	20B	64-202	20C	64-203	21"
22"	21A	64-211	21B	64-212	21C	64-213	22"
23"	22A	64-221	22B	64-222	22C	64-223	23"
24"	23A	64-231	23B	64-232	23C	64-233	24"
25"	24A	64-241	24B	64-242	24C	64-243	25"
26"	25A	64-251	25B	64-252	25C	64-253	26"
27"	26A	64-261	26B	64-262	26C	64-263	27"
28"	27A	64-271	27B	64-272	27C	64-273	28"
29"	28A	64-281	28B	64-282	28C	64-283	29"
30"	29A	64-291	29B	64-292	29C	64-293	30"
31"	30A	64-301	30B	64-302	30C	64-303	31"
32"	31A	64-311	31B	64-312	31C	64-313	32"
33"	32A	64-321	32B	64-322	32C	64-323	33"
34"	33A	64-331	33B	64-332	33C	64-333	34"
35"	34A	64-341	34B	64-342	34C	64-343	35"
36"	35A	64-351	35B	64-352	35C	64-353	36"
37"	36A	64-361	36B	64-362	36C	64-363	37"
38"	37A	64-371	37B	64-372	37C	64-373	38"

64 Series Balance Accessories

TOP BRACKET

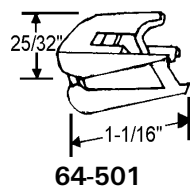
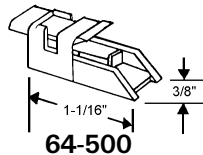

BOTTOM BRACKETS

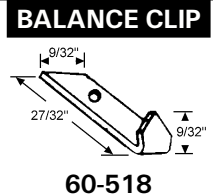
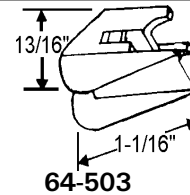
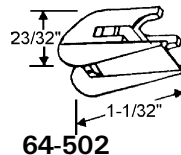

RIVET

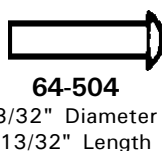

SASH GUIDE

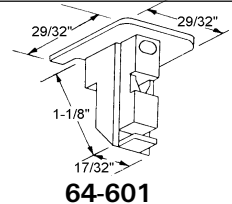
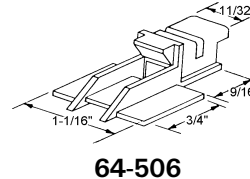
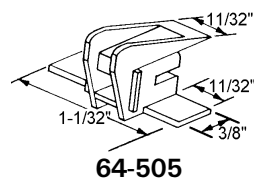
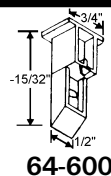

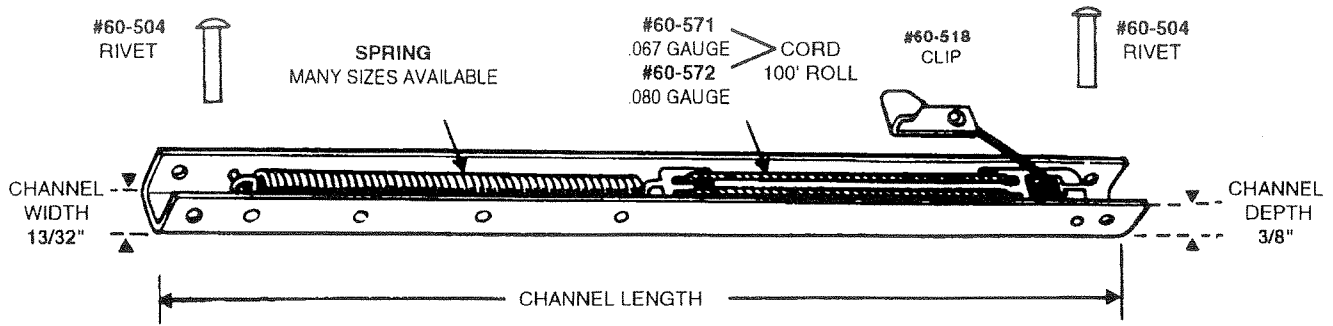

ORDERING INFORMATION

- 1) Measure metal channel length. Do not include any attached brackets.
- 2) Check number stamped on channel e.g. 19A, 22B, 28C, etc.
- 3) Select our corresponding part number from the chart below.
- 4) Identify the appropriate clip to be attached from the illustration shown, then add 1 or 2 to complete our part number.
- 5) Select related accessories for this balance from page ____.

EXAMPLE ORDERING CHART

Channel Length	Number Stamped	Part Number	Balance Clip	Complete Part Number
22"	21A	64T-211	1	64T-211-1
22	21A	64T-211	2	64T-211-2

Balance Clips

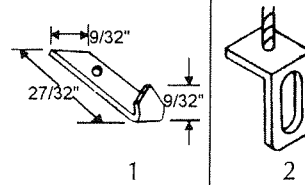

LENGTH OF METAL CHANNEL	NUMBER STAMPED ON BALANCE	OUR PART NUMBER	NUMBER STAMPED ON BALANCE	OUR PART NUMBER	NUMBER STAMPED ON BALANCE	OUR PART NUMBER
10"	9A	64T-091-__	9B	64T-092-__	9C	64T-093-__
11"	10A	64T-101-__	10B	64T-102-__	10C	64T-103-__
12"	11A	64T-111-__	11B	64T-112-__	11C	64T-113-__
13"	12A	64T-121-__	12B	64T-122-__	12C	64T-123-__
14"	13A	64T-131-__	13B	64T-132-__	13C	64T-133-__
15"	14A	64T-141-__	14B	64T-142-__	14C	64T-143-__
16"	15A	64T-151-__	15B	64T-152-__	15C	64T-153-__
17"	16A	64T-161-__	16B	64T-162-__	16C	64T-163-__
18"	17A	64T-171-__	17B	64T-172-__	17C	64T-173-__
19"	18A	64T-181-__	18B	64T-182-__	18C	64T-183-__
20"	19A	64T-191-__	19B	64T-192-__	19C	64T-193-__
21	20A	64T-201-__	20B	64T-202-__	20C	64T-203-__
22"	21A	64T-211-__	21B	64T-212-__	21C	64T-213-__
23"	22A	64T-221-__	22B	64T-222-__	22C	64T-223-__
24"	23A	64T-231-__	23B	64T-232-__	23C	64T-233-__
25"	24A	64T-241-__	24B	64T-242-__	24C	64T-243-__
26"	25A	64T-251-__	25B	64T-252-__	25C	64T-253-__
27"	26A	64T-261-__	26B	64T-262-__	26C	64T-263-__
28"	27A	64T-271-__	27B	64T-272-__	27C	64T-273-__
29"	28A	64T-281-__	28B	64T-282-__	28C	64T-283-__
30"	29A	64T-291-__	29B	64T-292-__	29C	64T-293-__
31"	30A	64T-301-__	30B	64T-302-__	30C	64T-303-__
32"	31A	64T-311-__	31B	64T-312-__	31C	64T-313-__
33"	32A	64T-321-__	32B	64T-322-__	32C	64T-323-__
34"	33A	64T-331-__	33B	64T-332-__	33C	64T-333-__
35"	34A	64T-341-__	34B	64T-342-__	34C	64T-343-__
36"	35A	64T-351-__	35B	64T-352-__	35C	64T-353-__
37"	36A	64T-361-__	36B	64T-362-__	36C	64T-363-__
38"	37A	64T-371-__	37B	64T-372-__	37C	64T-373-__

Terminal Housing
64T500

Compatible Hardware

<i>Pivot Bars</i>	<i>Tilt Studs</i>	<i>Cams</i>
900-14396	62-616*	64T-501
900-14302	62-617*	64T-502
900-14305*	62-603*	<i>Pivot Retainer</i>
900-14306*	62-604*	64T-505
900-14307*	62-620*	
900-14308	62-621*	
900-14309	<i>Brake Shoes</i>	
900-14310	64T-503	
85-513	64T-504	
62-618*		
62-619*		

Terminal Housing

900-14315, 900-14316
900-14317, 900-14318
900-14319, 900-14320
900-14321, 900-14322

Compatible Hardware

<i>Pivot Bars</i>
900-14395
900-14302
900-14308
900-14309
900-14310
85-513
<i>Pivot Retainer</i>
62-660

*Use with 64T-502 Take-out Cam only

Terminal Housing

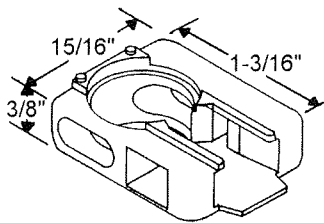

64T-500

Cams

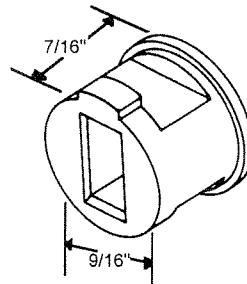

64T-501

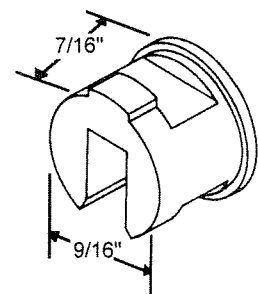

64T-502

Brake Shoes

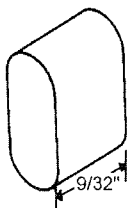

64T-503

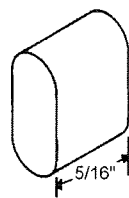

64T-504

Pivot Retainer

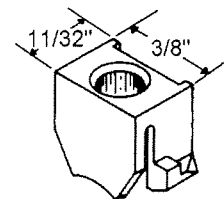

64T-505