

SHOWER DOOR HARDWARE

SHOWER DOOR ROLLERS

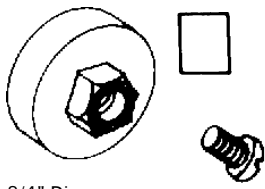

3/4" Dia.
1/4" Wide
3/8" Hub
8 - 32x3/8" Screw

21-50
Nylon

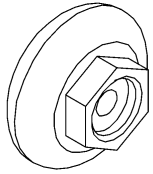

3/4" Dia.
1/4" Wide
3/8" Hub
8 - 32x3/8" Screw

21-51
Nylon



7/8" Dia.
1/4" Wide
3/8" Hub
8 - 32x3/8" Screw

21-66
Nylon

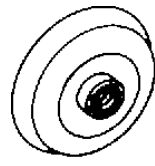

7/8" Dia.
5/16" Wide
3/8" Hub
8 - 32x3/8" Screw

21-52
Nylon



1-1/16" Dia.
7/32" Wide
9/32" Hub
10 - 24x3/8" Screw

21-53
Nylon

SHOWER DOOR ROLLER ASSEMBLIES

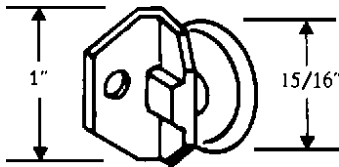

21-63
Nylon

Roller Only 21-65

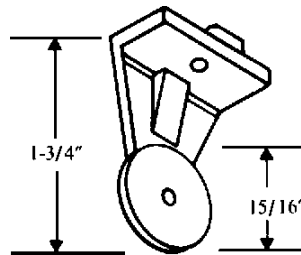

21-64
Nylon

Roller Only 21-65

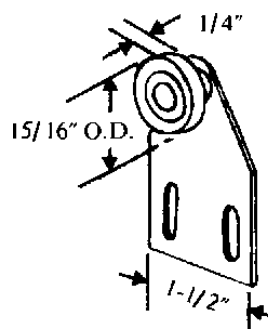

21-54

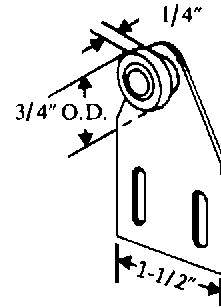

21-56

Roller Only 21-50

SHOWER DOOR ROLLER ASSEMBLIES

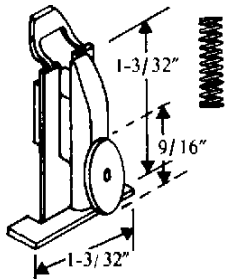

21-62
Nylon w/Aluminum
Bracket

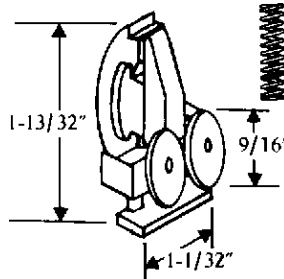

21-59
Nylon

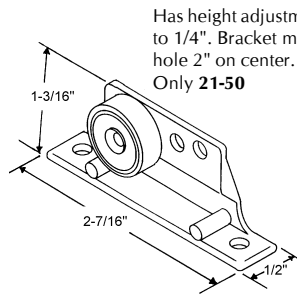

21-57 With 21-50 Roller
21-58 With 21-51 Roller
Die Cast

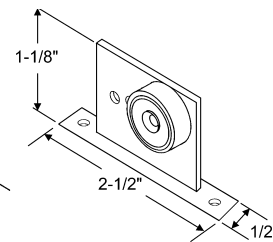

21-57NS
Nylon

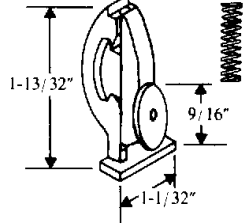

21-60
Nylon

SHOWER DOOR GUIDES

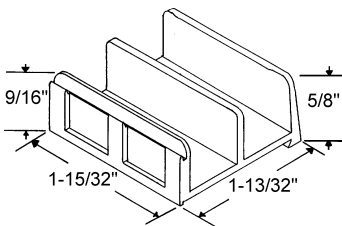

900-17327

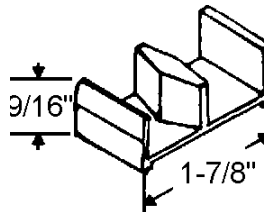

22-50

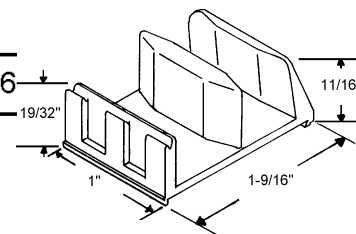

900-17497

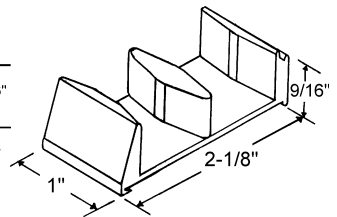

900-10563

SHOWER DOOR HARDWARE

ACCESSORIES

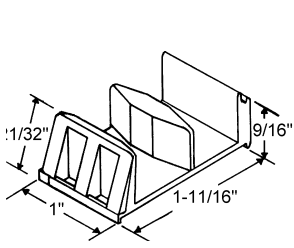

900-6426

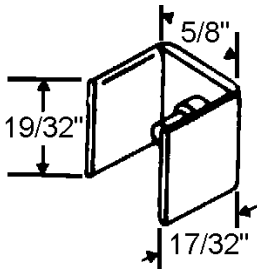

22-51
Nylon

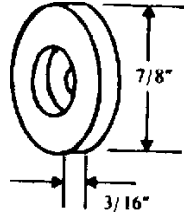

22-53

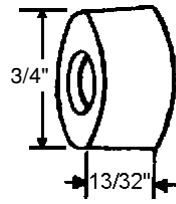

22-66

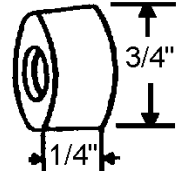

22-65
Clear Plastic

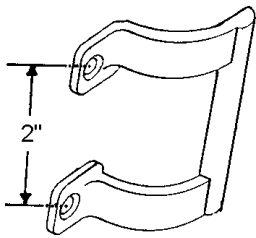

22-67
Chrome

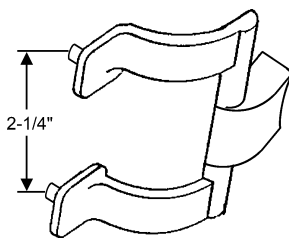

900-10709
Chrome

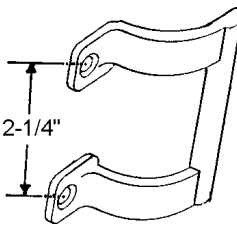

900-9079
Chrome

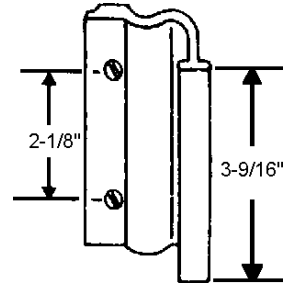

22-57
Old Style
No Longer Available

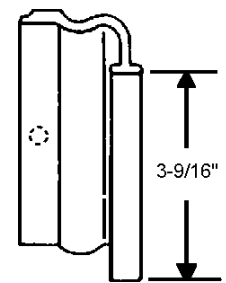

22-57NEW
White
2 piece set

SHOWER DOOR LATCH

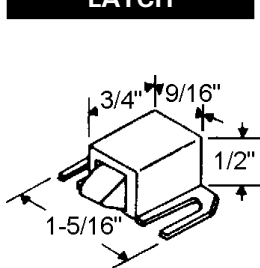

22-54

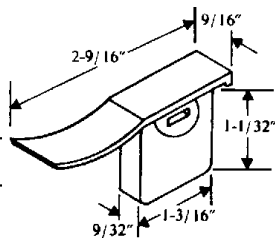

22-59

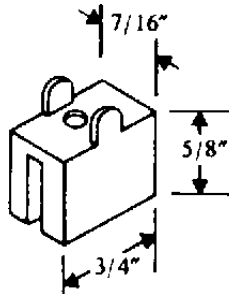

22-60

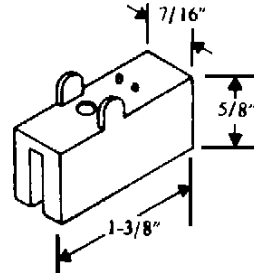

22-61

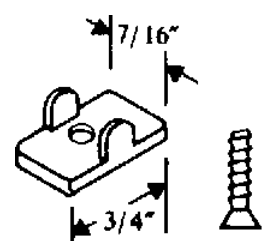

22-58

SHOWER DOOR SEAL

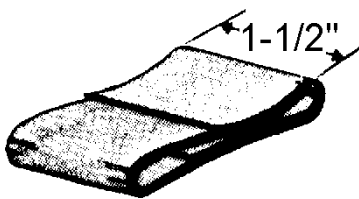

22-52
Gray
36" long

TOWEL/GRAB BAR STUD ASSEMBLY

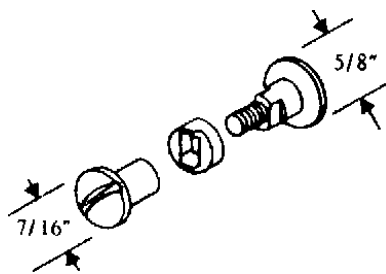

20-073 Silver
20-073G Gold

FOLD-LINE ROD

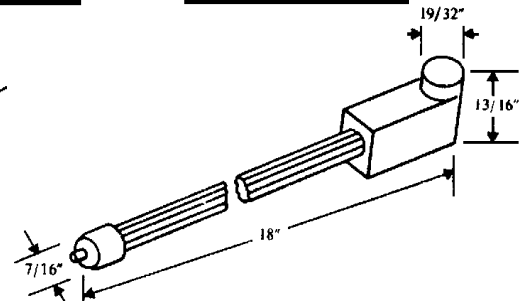

22-62

Hinge Brackets For Steel Pilasters

Top Hinge

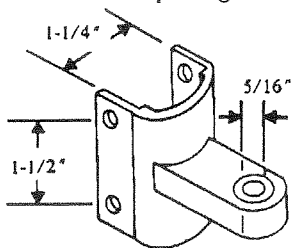

91-2

Bottom Hinge

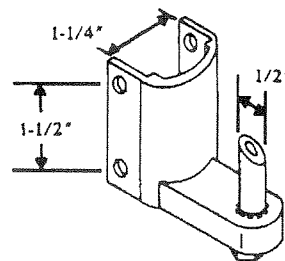

91-3

Note:

This is a sample of hardware now in stock. If you do not see what you need, send us a sample for immediate identification.

Gravity Hinge Set

Surface Mounted, Stainless Steel

- 91-29 Set for R.H. Inswing or L.H. Outswing
- 91-28 Set for L.H. Inswing or R.H. Outswing

For any thickness or material of pilasters and doors.
Set contains one top hinge and one bottom hinge.

Note:

To determine the handedness of the door, facing the outside of the stall, if the door swings into the stall with the hinges on the left, the door is "Left Hand Inswing"

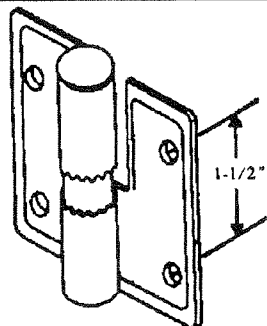

Top Hinge

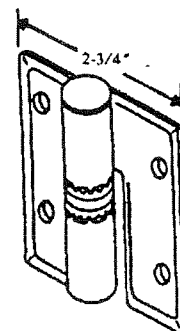

Bottom Hinge

Concealed Latches & Emergency Covers

Slide Latches

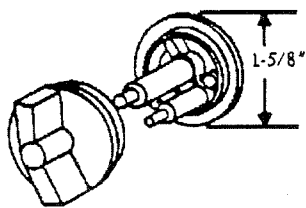

91-8

For Steel Doors

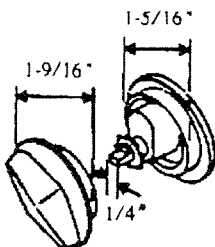

91-84

For Steel Doors

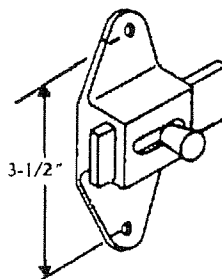

91-4

Surface Mounted

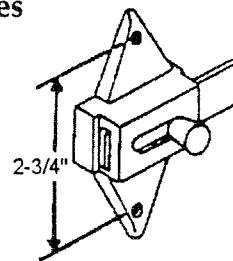

91-79

Surface Mounted

Part #	Pilaster Size
91-32	3"
91-34	4"
91-36	5"
91-38	6"
91-40	7"
91-42	8"
91-44	10"
91-46	11"

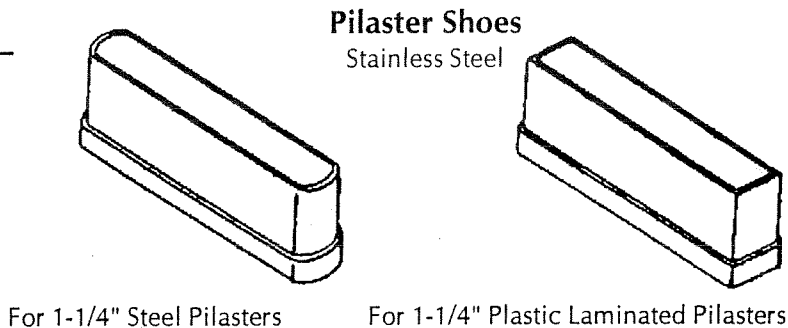

Pilaster Shoes

Stainless Steel

For 1-1/4" Steel Pilasters

For 1-1/4" Plastic Laminated Pilasters

Part #	Pilaster Size
91-33	3"
91-35	4"
91-37	5"
91-39	6"
91-41	7"
91-43	8"
91-45	10"
91-47	11"

UN-DO-IT One Way Screw Remover

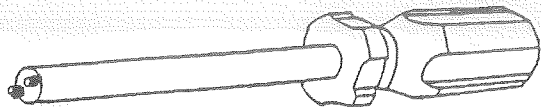

Part #	Screw Sizes
59-15	6-8
59-16	10-12
59-17	14 (1/4)
59-18	Set of Three

Tips made of tungsten carbon.
Works like an ordinary screwdriver.
Exclusive no slip tip design provides maximum holding power until screw is removed.

Two Ear

One Ear

Part#	Panel Thickness	Bracket Height
91-17	1"	2-1/2"
91-18	1-1/4"	2-1/2"
91-97	1"	3-1/2"

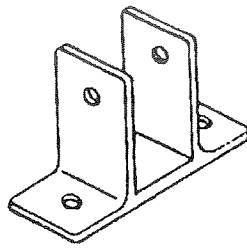

Part#	Panel Thickness	Bracket Height
91-67	7/8"	2-1/2"
91-15	1"	2-1/2"
91-16	1-1/4"	2-1/2"

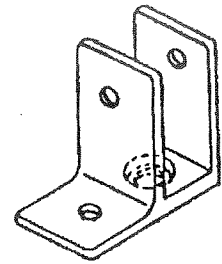

ACCESSORIES

Post Base

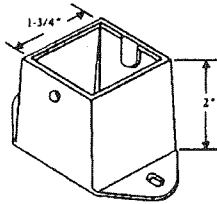

91-21

Post Cap

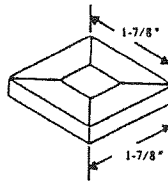

91-20

Floor Bracket

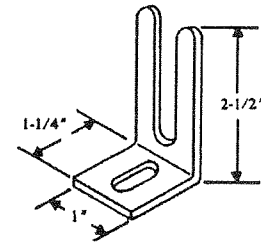

91-22

Shoe Clip

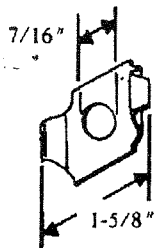

91-23

Anti-Grip Headrail End Plug

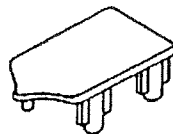

For 1-1/2" x 1" Anti-Grip Tubing

91-63

Rectangular Headrail End Plug

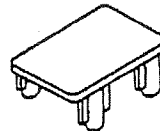

For 1-1/2" x 1" Rectangular Tubing

91-64

Door Stop

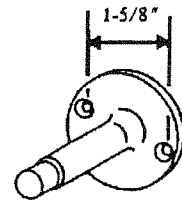

91-10

Coat Hook & Bumper

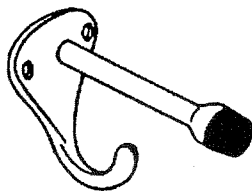

91-6

Two Prong Coat Hook



91-7X
Chrome Finish

Single Prong Coat Hook

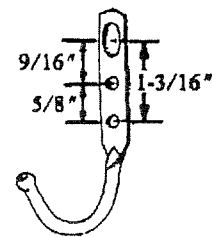

Oval holes adjust from 5/8" to 7/8" spacing

95-8

Tissue Cabinet

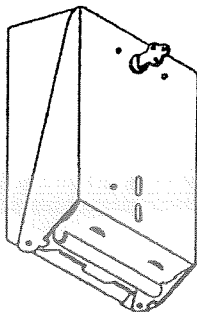

91-50

Toilet Tissue Dispensers

18 gauge steel with polished chrome finish. Locking mechanism prevents removal of roll until paper is used.

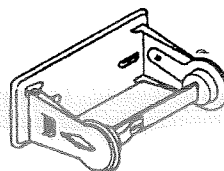

91-48

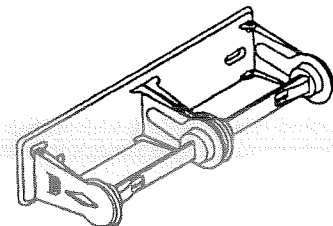

91-49

Towel Bar Set
3/4" square x 24"

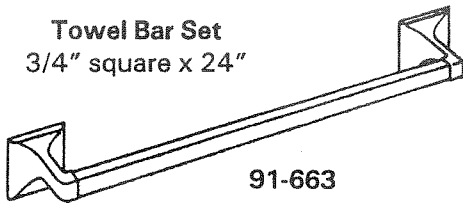

91-663

- Zinc Die Cast
- Chrome Plated
- Concealed Screw Mounts

Soap Dish

91-659

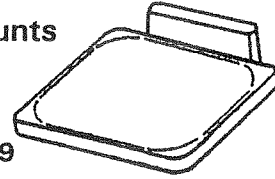

Tissue Paper Holder
w/white plastic roller

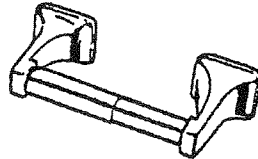

91-660

Toothbrush/Tumbler Holder

91-658

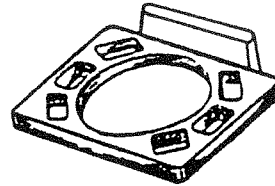

Slide Latch

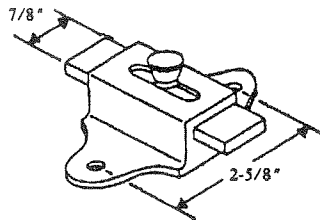

91-83
Surface Mounted

Throw Latch

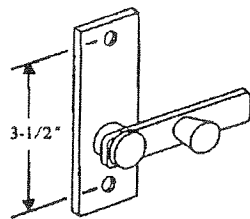

91-80
Surface Mounted

Door Pulls

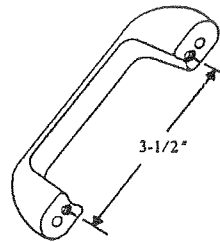

91-9
Mounting Holes Tapped 10-24

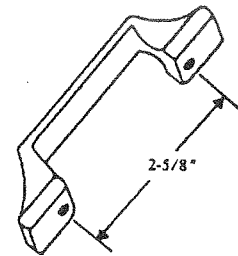

91-90
Mounting Holes Tapped 10-24

Bumper Keeper

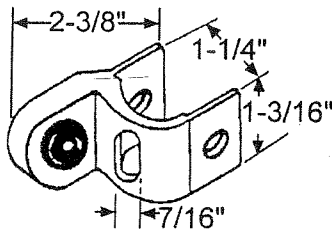

91-5
For steel pilaster with
concealed latch.

Keeper & Strike

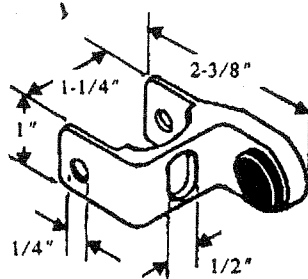

91-87
For steel pilaster with
concealed latch.

Outswing Keeper & Strike

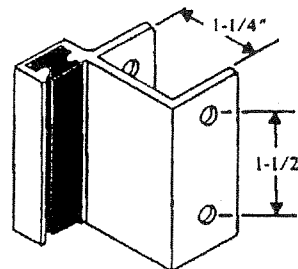

91-78
For plastic laminate pilaster
with surface slide latch.

Inswing Keeper & Strike

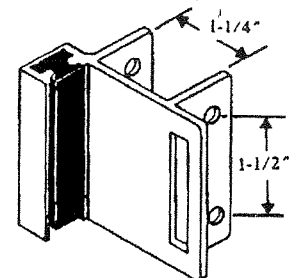

91-26
For plastic laminate pilaster
with surface latch.

Strikes

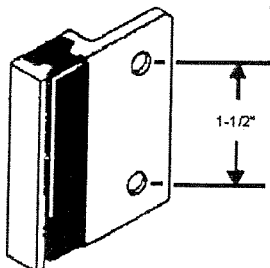

91-82
For any thickness pilaster

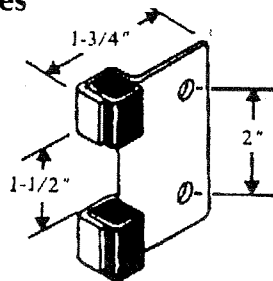

91-88
For any thickness pilaster

Inswing Keeper

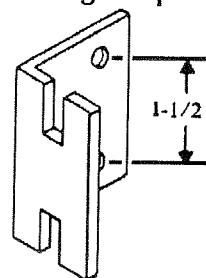

91-81
For any thickness pilaster
with throw latch

Keeper

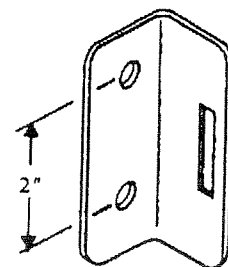

91-89

U Brackets

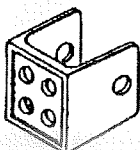

Part #	Panel Thickness	Bracket Height
91-76	7/8"	1-11/32"
91-12	1"	1-11/32"

Headrail Bracket

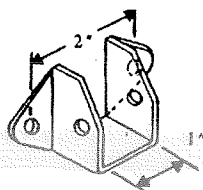

91-13

Urinal Screen Bracket

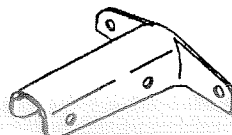

91-11
1-1/4" x 6" long

Alcove Angle Bracket



91-14
For steel panel

Alcove Bracket

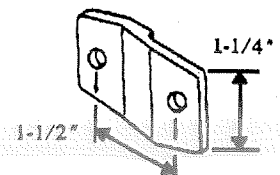

91-70
For plastic laminated
panel. 4 required
per panel

HINGE BRACKETS

TOILET PARTITION HARDWARE

Hinge Brackets For Steel Pilasters

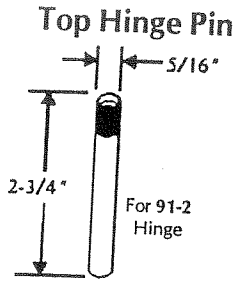

91-1

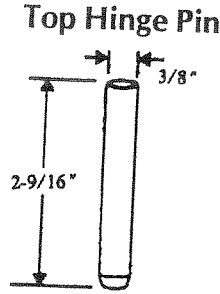

91-96

Top Hinge Assembly

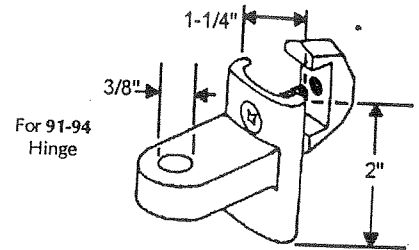

91-94

Bottom Hinge Assembly

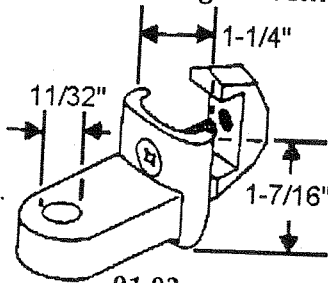

91-93

Top Hinge

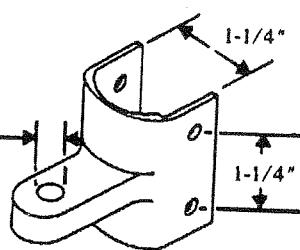

91-85

Bottom Hinge

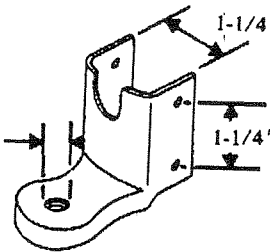

91-86

Bottom Hinge Assembly

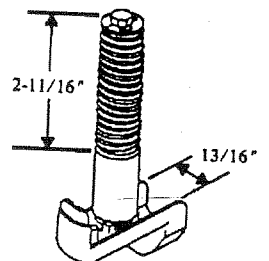

91-95

Hinge Brackets For Plastic Laminated Pilasters

Top Hinge Pin

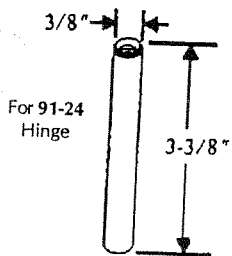

91-71

Top Hinge

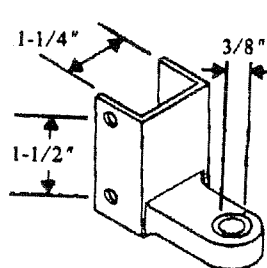

91-24

Bottom Hinge

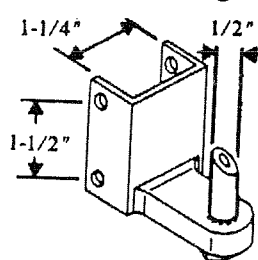

91-25

Top Door Insert

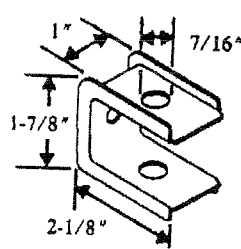

91-72

Bottom Door Insert

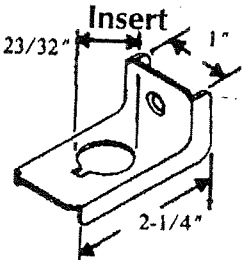

91-73

Bottom Hinge Cam Assembly

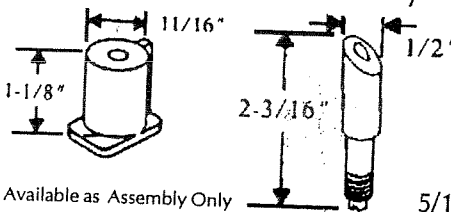

91-102

Lock Washers

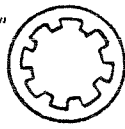

6-115
5/16" Internal
Tooth



6-118
5/16" External
Tooth

Hex Nut



6-128
5/16" x 18

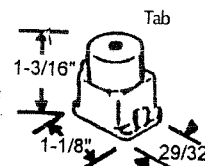

91-189
White Plastic

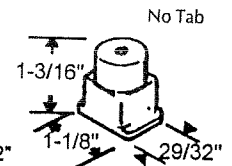

91-190
White Plastic

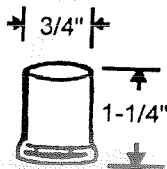

91-113
White Plastic
Bracket 91-117
for 1" Door

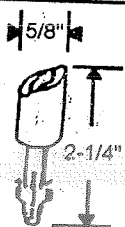

91-148
Fits cams 91-189,
91-190 & 91-113

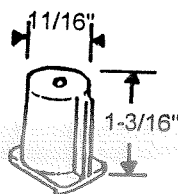

91-191
White Plastic
Fits Bracket 91-73

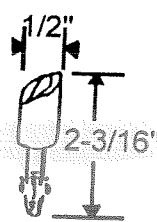

91-102B
Fits Cams 91-191
& 91-114

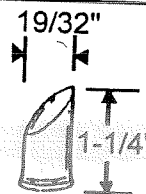

91-114
White Plastic
Fits Bracket 91-153
for 7/8" thick doors

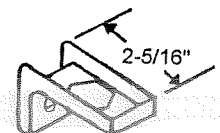

91-117 for 1"
thick doors
91-153 for 7/8"
thick doors