

STORM DOOR HARDWARE

LATCHES



For all outswinging doors 1" to 1-1/4" thick. mounts 1-3/4" center to center.

17-53 Aluminum

17-54 Black

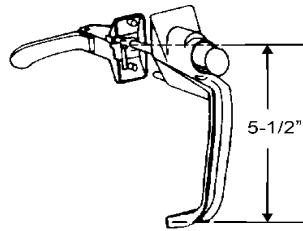

For all outswinging doors 1" to 1-1/4" thick. Distance between center holes (mounting screw) is 1-1/2".

17-65 Aluminum

17-66 Black

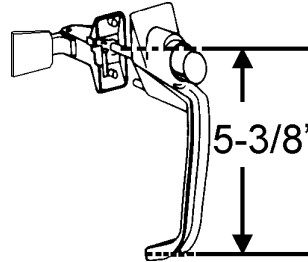

For all outswinging doors 5/8" to 1-1/4" thick. 1-3/4" mounting hole spacing.

17-82 Black

17-82A Aluminum

17-82W White

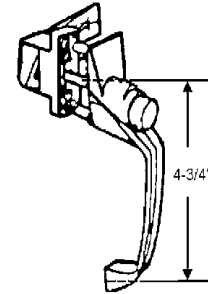

For all outswinging doors 5/8" to 1-1/4" thick. 1-3/4" mounting hole spacing.

17-72 Black

17-73 Aluminum

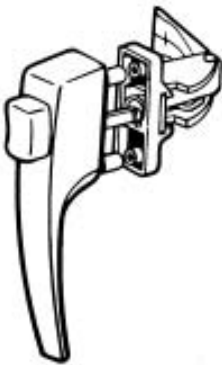

For all outswinging doors 1" to 1-1/4" thick. mounts 1-3/4" center to center.

17-55 Aluminum

17-56 Black

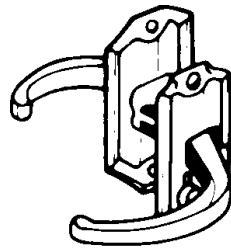

For all outswinging doors 1" to 1-1/4" thick. Installed in a 1" diameter single hole bore

17-67 Aluminum

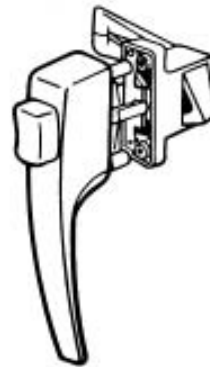

For all outswinging doors 5/8" to 1-1/4" thick. 1-3/4" mounting hole spacing.

17-70 Aluminum

17-71 Black

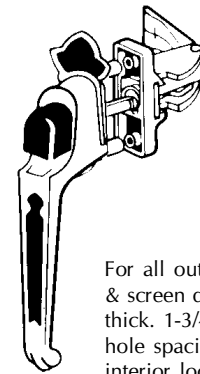

For all outswinging storm & screen doors 1" to 1-1/4" thick. 1-3/4" mounting hole spacing. Features an interior locking & anti-lockout mechanism. Installs in three 1/4" holes and has a spring loaded strike plate. Finish two tone black & aluminum

17-83 Not Available Use

17-156

EASY LIFT HANDLE

with Inside Latch

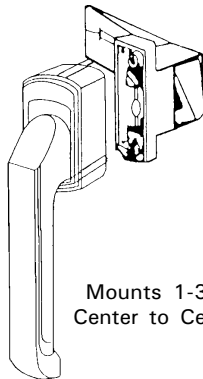

Mounts 1-3/4" Center to Center.

17-75-1 Black

17-75-2 Aluminum

17-75-3 White

17-75-4 Brown

17-75-5 Gold

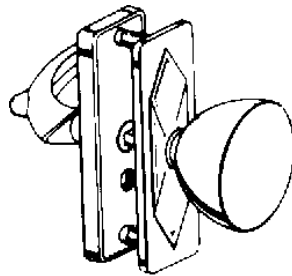

For all Outswinging Doors 1" to 1-1/4" thick. 3" Center to Center Hole Spacing.

17-50 Aluminum

17-51 Black

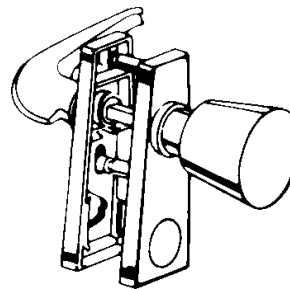

For all Outswinging Doors 1" to 1-1/4" thick. Mounts 1-3/4" Center to Center.

17-60 Aluminum

17-59 Black

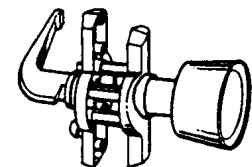

For all Outswinging Storm or Jalousie Doors 1" to 1-1/4" thick. Single Hole Bore 1-1/4" Diameter.

17-52 Aluminum

TOLL FREE 800-352-0800

2003, SBI®

strybuc

171

Return to Table of Contents

STORM DOOR

LEVER HANDLE HEAVY DUTY & INSIDE LATCH

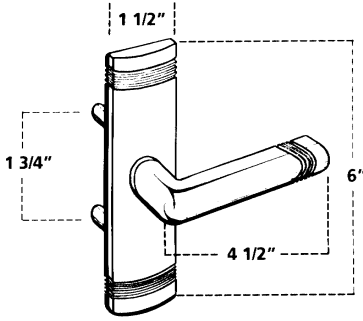

17-78-1 Black
 17-78-3 White
 17-78-55 Metallic Gold
 Housing And Latch

Other Colors Available

- Designed to accentuate door appearance.
- Replace and upgrade your existing hardware to be in compliance with ADA entry requirements.
- Easy to grip for all, including the handicapped, the elderly and small children.
- Made of heavy duty zinc die cast.
- Available in black or white baked enamel or polished brass plated finishes.
- Non-handed fits right or left handed applications, no adjustments required.
- Standard 1-3/4" hole spacing.

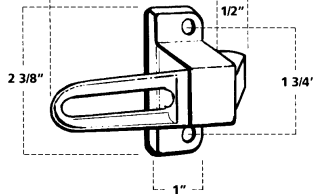

COMBINATION ENTRANCE AND DEAD LOCK



Escutcheon

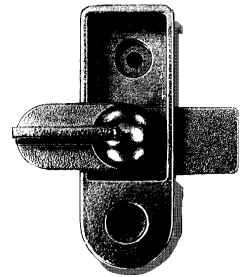

Dead Lock

17-7-1 Black
 17-7-3 White
 17-7-55 Metallic Gold Housing And
 Interior Dead Lock
 Includes both interior & exterior locks

Dead Lock Only

17-6-1 Black
 17-6-3 White

TOUCHBAR LATCH™

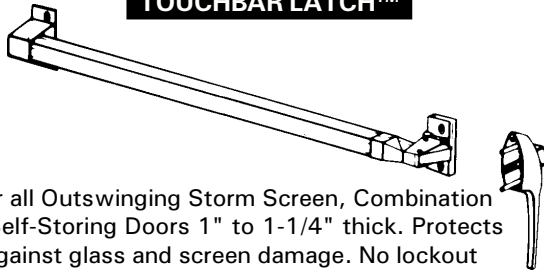

For all Outswinging Storm Screen, Combination or Self-Storing Doors 1" to 1-1/4" thick. Protects against glass and screen damage. No lockout feature. Replaces most latches
 Mounting Hole Center 1-3/4"

17-63-1 Black
 17-63-2 Aluminum
 17-63-3 White
 17-63-4 Brown
 17-63-5 Chrome

STORM DOOR HARDWARE KIT

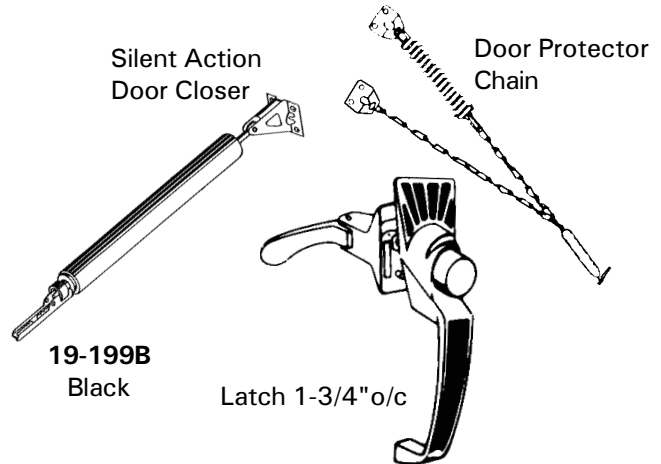

Silent Action
 Door Closer

Door Protector
 Chain

19-199B
 Black

Latch 1-3/4" o/c

17-68-1 Black - Inside & Outside
 Latch Only

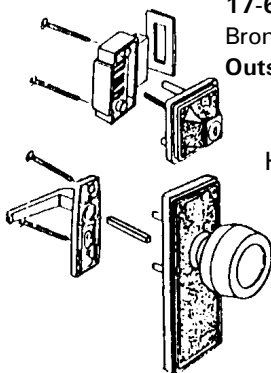

17-68-7 Antique
 Bronze - Inside &
 Outside Latch Only

Hess Mfg.

17-68K-1 Black - With Key lock. The
 Complete Set Shown Above
 17-68K-7 Antique Bronze -With Key
 lock. The Complete Set Shown Above
 Mounting Hole Center 1-3/4"

STORM & SCREEN DOOR LATCH

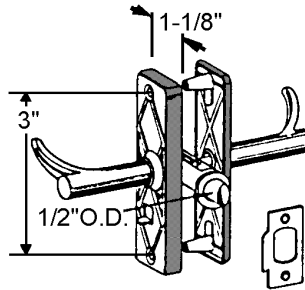

900-14851 Aluminum
 900-14851K w/key Aluminum
 900-14851B Black
 900-14851BK w/key Black

Designed to fit most combination screen and storm doors; reversible; slide lock for extra security; accepts 7/8" to 1-1/4" door thickness; 3/4" backset; aluminum finish. Mounting Hole Center 3-1/16"

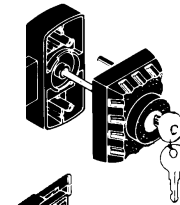

900-13554DB
 Black
 Deadbolt Set with
 Key Only.

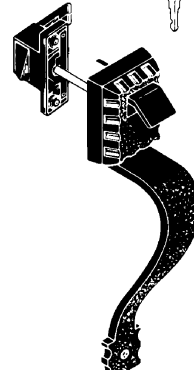

900-13554 Black
 Push Button Latch
 Set Only.

900-13554K Black
 With Key lock.
 Complete Assembly
 as Shown

Mounting Hole Center 1-3/4"

STORM AND SCREEN DOOR CLOSERS

"Heavyweight" Door Closer

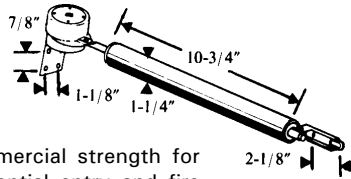

Commercial strength for residential entry and fire doors. "Auto-Hold" automatic hold open feature. Exclusive tension adjustment requires no special tools.

18-50 Aluminum

18-51 Bronze

Pneumatic and hydraulic screws included
OLD STYLE NO LONGER AVAILABLE

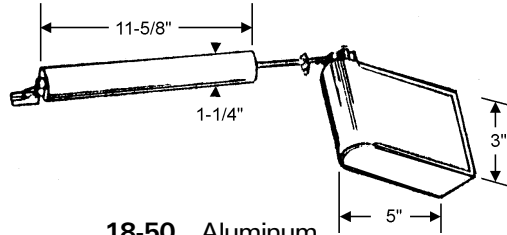

18-50 Aluminum
18-51 Gold

Heavy-Duty for outswinging and inswinging doors with 3-way power adjustment. All hardware included.

California Door Closer

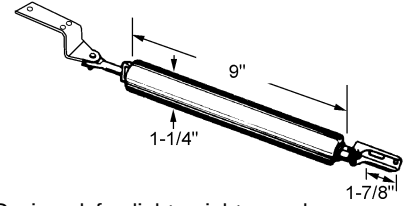

Designed for lightweight wood or aluminum screen doors. Not recommended for storm doors. Permanently lubricated. Must be installed on rail at top of door.

18-52 Aluminum

18-53 Black

Hydraulic Door Closer

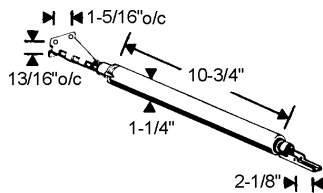

For all doors up to 1-1/4" thick. Temperature changes do not affect closing action. Permanently lubricated. Adapter plates to cover old holes.

18-54 Aluminum

Not Available

Use **18-71**

Adjustable Hydraulic Door Closer

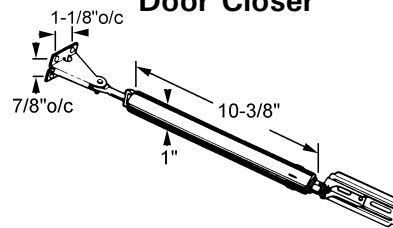

For all storm and screen, jalousie or light interior doors up to 1-1/4" thick. No tools needed to adjust - just rotate tube. Permanently lubricated.

18-55 Aluminum

18-56 Black

"Smooth Aire" Heavy Duty Door Closer

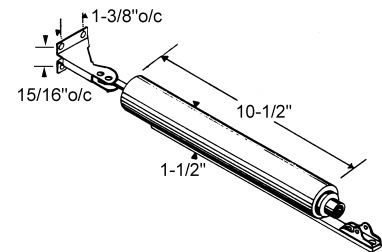

For storm and screen, jalousie or interior doors up to 1-3/4" thick. Has two times the power of standard closers at latching position. Permanently lubricated. Adjustable speed control.

18-58 Aluminum

18-57 Black

"Sure Latch" Door Closer

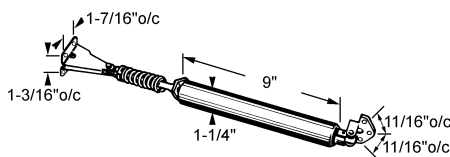

For doors up to 1-1/4" thick. Permanently lubricated. Adjustable latching power. Packed with 2 door brackets.

18-61 Aluminum

18-60 Black

Economy Air Closer

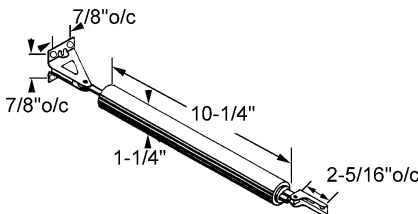

For doors up to 1-1/4" thick. Adjustable closing power.

18-63 Aluminum

18-62 Black

18-62W White

Silent Action Door Closer

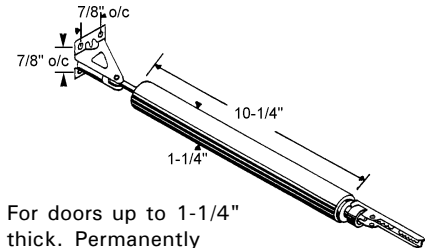

For doors up to 1-1/4" thick. Permanently lubricated. Adjustable latching power. Adapter plates to cover old holes

18-65 Aluminum

18-64 Black

Hydraulic Door Closer

with Automatic Hold Open/Easy Close Feature

For doors up to 1-1/4" thick. Temperature changes do not affect closing action. Permanently lubricated.

18-71 Aluminum

18-71B Black

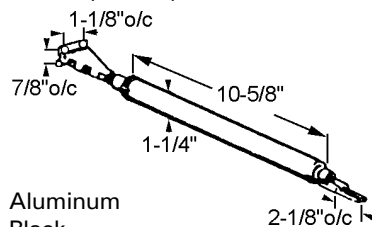

Rotary Hydraulic Door Closer

18-67
 Aluminum

For all doors 3/4" to 1-1/8" thick. Top doors jamb application. 180° door opening eliminates the need for a door protector chain. Permanently lubricated. Adjustable closing power.

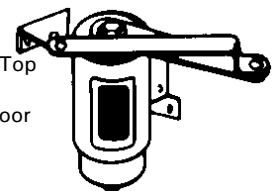

STORM DOOR ACCESSORIES

PANEL CLIPS

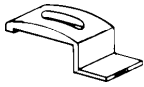

19-100 Aluminum
19-108 White
19-109 Brown
 1/4" Offset

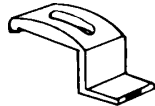

19-102 Aluminum
19-110 White
19-111 Brown
 3/8" Offset



19-122 Aluminum
19-112 White
19-113 Brown
 1/4" Offset

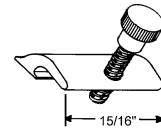

900-8004 Mill
900-8004BE Beige
900-8004BR Brown
900-8004W White
 Seasonall

PANEL INSERT CLIP



19-129
 Nylon



900-16732
 White Plastic
 Acadia



19-116 Aluminum
19-123 White
19-123B Brown



19-114 Aluminum
19-114W White
19-114B Brown

RESILIENT STRIKE PLATES



For all latches or locks with a solid latch nose. Slotted holes for easy adjustment.

19-119 Aluminum Not Available
 Use **19-295**
19-120 Black Not Available
 Use **19-300**
 Low Profile

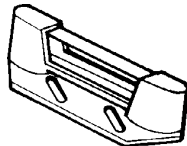

19-194A
19-194B

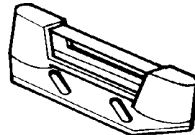

19-300A Aluminum
19-300 Black
 9/16" High Profile

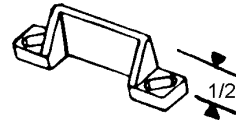

19-197A Aluminum
19-197B Black

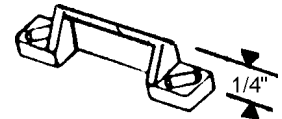

19-185A Aluminum
19-185B Black

WHITE PLASTIC SHIM



19-186
 1/8" Thick
 For **19-119** & **19-120**

3" PUSHBUTTON

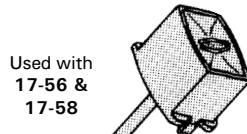

Used with
17-56 &
17-58

19-131
 Black Plastic



19-192
 Round Plastic Button
 Black

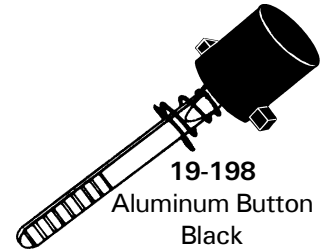

19-198
 Aluminum Button
 Black
 Replaces Plastic **19-192**

LOCK SPINDLE

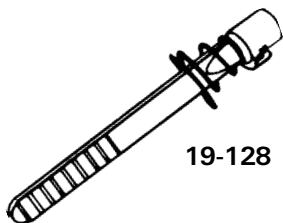

19-128

ALUMINUM PUSH BAR

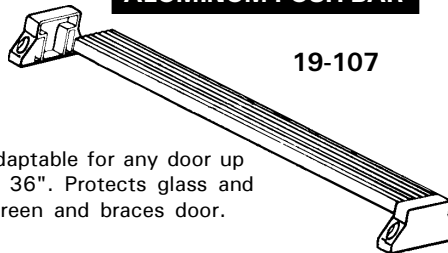

19-107

Adaptable for any door up to 36". Protects glass and screen and braces door.

DOOR PROTECTOR CHAIN

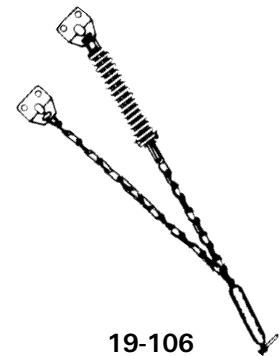

19-106

Includes hold-up spring to prevent chain from hitting door and scratching glass.

KEY LOCKS

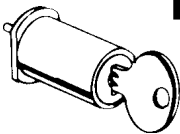

Convert **17-61** and **17-60** latches to key locking sets.

19-121

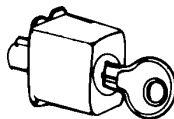

Converts **17-55**, **17-56** and **17-57**, **17-58** latches to key locking sets.

19-126 Aluminum
19-127 Black Not Available Use **19-127X**

PUSHBUTTON KEY LOCK

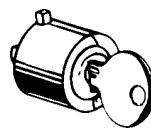

Converts **17-53**, **17-54** and **17-65**, **17-66** latches to key locking sets.

19-124 Aluminum
19-125 Black

STORM & SCREEN DOOR HARDWARE

KNOB LATCHES & LOCKS

**ALL
NEW
PRODUCTS!**

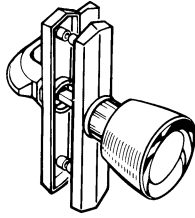

666



Tulip Knob Latch

17-110 Aluminum

17-110B Black

(3" hole spacing)

- For outswinging wood or metal doors.
- Fits doors 7/8" to 1-1/8" thick.
- Installs in three 5/16" holes.
- Backset from jamb (door stop) 1"
- Installs with spring loaded strike plate.
- Covers most previous installation drilling in door.

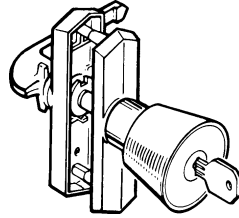

909



Tulip Key-In-Knob Lock

900-7320 Aluminum

(3" hole spacing)

- For outswinging wood or metal doors.
- Fits doors 7/8" to 1-3/8" thick.
- Installs in three 1/2" holes.
- Backset from jamb (door stop) 1"
- Installs with spring loaded strike plate.
- Covers most previous installation drilling in door.
- Key lock for extra security.

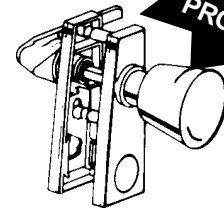

888



"No Lock Out" Tulip Knob Latch

17-61 Aluminum

- For outswinging wood or metal doors.
- Fits doors 7/8" to 1-1/4" thick.
- Installation hole spacing 1-3/4".
- Installs in three 5/16" holes.
- Backset from jamb (door stop) 7/8"
- Installs with solid strike plate.
- "No Lock Out" feature prevents accidental lock out.
- Can be converted to key locking set. Use V7 cylinder.

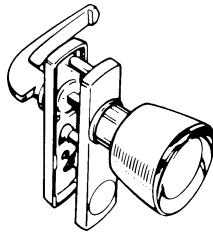

777



Tulip Knob Latch

17-105 Aluminum

17-106 Black

- For outswinging wood or metal doors.
- Fits doors 7/8" to 1-1/8" thick.
- Installation hole spacing 1-3/4".
- Installs in three 5/16" holes.
- Backset from jamb (door stop) 7/8"
- Installs with spring loaded strike plate.
- Can be converted to key locking set. Use 19-121 cylinder.

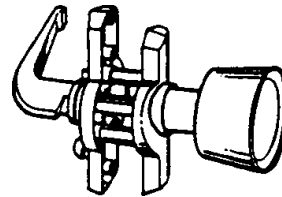

501



Single Hole Tulip Knob Latch

17-52 Aluminum

- For outswinging wood or metal doors.
- Fits doors 7/8" to 1-1/4" thick.
- Installs with single 1-1/4" hole.
- Backset from jamb (door stop) 1"
- Installs with spring loaded strike plate.

PUSH BUTTON LATCHES & LOCKS



Wright TOUCH

Storm Door Latch

Comfortable "Champagne" colored grip and push button of pliable santoprene combined with a durable zinc body available in today's most popular exterior trim colors. Replaces most latches with 1-3/4" hole spacing. For 3/4" to 1-1/4" thick wood or metal storm door

Part #	Color
17-120	White
17-121	Black
17-122	Almond
17-123	Champagne
17-124	Bronze
17-125	Hunter Green
17-126	Cranberry Red

TOLL FREE 800-352-0800

2003, SBI®

strybug

xi

Return to Table of Contents

STORM & SCREEN DOOR HARDWARE

**ALL
NEW
PRODUCTS!**



Colonial Push Button Latch
(Free Hanging Handle)
900-7340AL Aluminum
900-7340 Black

- For 1" to 1-1/4" outswinging wood or metal doors.
- Installation hole spacing 1-3/4"
- Installs in three 5/16" holes.
- "No Lock Out" feature prevents accidental lock out.
- Can be converted to key locking set. Use 19-121 cylinder.

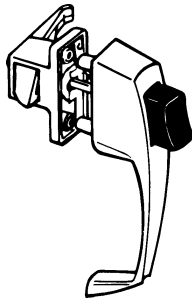

Push Button Latch
900-7339 Aluminum
900-7339BL Black

- For outswinging wood or metal doors.
- Fits doors 1" to 1-1/4" thick.
- Installation hole spacing 1-3/4".
- Installs in three 5/16" holes.
- Contains two sizes of strikes and shims to provide adjustment for latching.
- "No Lock Out" feature prevents accidental lock out.
- Can be converted to key locking set. Use 19-121 cylinder.

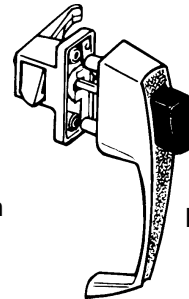

398
Push Button Latch
17-95 Aluminum
17-96 Black

- (1-1/2" hole spacing)
- For outswinging wood or metal doors.
 - Fits doors 1" to 1-1/4" thick.
 - Installs in three 5/16" holes.
 - Contains two sizes of strikes and shims to provide adjustment for latching.
 - "No Lock Out" feature prevents accidental lock out.
 - Can be converted to key locking set. Use 19-121 cylinder.

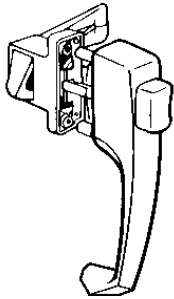

Push Button Latch
17-70 Aluminum
17-71 Black
(Free Hanging Handle)

- For outswinging wood or metal doors.
- Fits doors 1" to 1-1/4" thick.
- Installation hole spacing 1-3/4".
- Installs in three 5/16" holes.
- Contains two sizes of strikes and shims to provide adjustment for latching.
- "No Lock Out" feature prevents accidental lock out.
- Can be converted to key locking set. Use 19-121 cylinder.

PNEUMATIC CLOSERS

Part #	Color
18-140	White
18-141	Black
18-142	Champange Beige

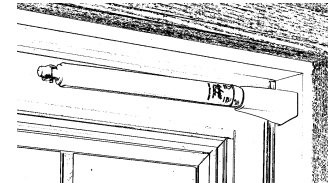

The Only Storm/Screen Door Closer Available With These Exclusive Features.

Easy Touch Closer

Color matched bracket cover "snaps" over jamb bracket for a less "mechanical" appearance. Turn dial to locked, open door to desired position. Door will remain in desired open position until dial is returned to unlocked position. Hold open will not "accidentally" disengage if bumped. Simply turn knob on closer to "fine tune" latching speed. No tools required!

Tube Length
11-5/8"

Tube Diameter
1-1/4"



660
Heavy Duty Torsion Spring Door Closer
18-50 Aluminum
18-50B Black
18-51 Brass

- For heavy storm doors, light exterior doors, interior and jalousie doors
- For wood or metal doors.
- For outswinging or inswinging doors.
- Full 90° opening.
- Two hole end plug for adjustable latching power.
- Adjustable closing speed.
- Factory Lubricated.

Tube Length
10-1/4"

Tube Diameter
1-1/2"



150
Heavy Duty Torsion Pneumatic Door Closer
18-97 Aluminum
18-97B Black
18-97W White
18-97G Gold

- For wood or metal doors.
- For outswinging doors.
- Full 90° opening.
- Two hole end plug for summer or winter adjustable latching power.
- Adjustable closing speed.
- Factory Lubricated.
- Internal spring for prevention of rod bending.

**ALL
NEW
PRODUCTS!**

STORM & SCREEN DOOR HARDWARE

<p>Tube Length 10-5/16"</p> <p>Tube Diameter 1-1/4"</p> <p>1020 Pneumatic Closer 18-91A Aluminum 18-91B Black</p> <ul style="list-style-type: none"> • For wood or metal doors. • For outswinging doors. • Full 90° opening. • Two hole end plug for summer or winter adjustable latching power. • Adjustable closing speed. • Factory Lubricated. • Internal spring for prevention of rod bending. 	<p>Tube Length 10-5/16"</p> <p>Tube Diameter 1-1/4"</p> <p>920 Pneumatic Door Closer 18-114 Aluminum 18-112 Black 18-113 White</p> <ul style="list-style-type: none"> • For wood or metal doors. • For outswinging doors. • Full 90° opening. • Two hole end plug for summer or winter adjustable latching power. • Adjustable closing speed. • Factory Lubricated. 	<p>Tube Length 9"</p> <p>Tube Diameter 1-1/4"</p> <p>820A Coastal Pneumatic Door Closer 18-98 Aluminum 18-98B Black 18-98BN Brown</p> <ul style="list-style-type: none"> • Aluminum anti-corrosive tube assembly • For coastal "salt air" climates. • For wood or metal doors. • For outswinging doors. • Full 90° opening. • Adjustable closing speed. • Factory Lubricated. 	<p>Tube Length 9"</p> <p>Tube Diameter 1-1/4"</p> <p>2105 Pneumatic Door Closer 18-61 Aluminum 18-60 Black 18-60W White</p> <ul style="list-style-type: none"> • Packed with wide & narrow door brackets. • For wood or metal doors. • For outswinging doors. • Full 90° opening. • Two hole end plug for summer or winter adjustable latching power. • Adjustable closing speed. • Factory Lubricated. • External spring for prevention of rod bending
-------------------------------------------------------------------------------------------------------------------------------------------------------------------------------------------------------------------------------------------------------------------------------------------------------------------------------------------------------------------------------------------------------------------------------------------------------------------------------------------------------------------	------------------------------------------------------------------------------------------------------------------------------------------------------------------------------------------------------------------------------------------------------------------------------------------------------------------------------------------------------------------------------------------------------------------------------------------------------------------------------	-------------------------------------------------------------------------------------------------------------------------------------------------------------------------------------------------------------------------------------------------------------------------------------------------------------------------------------------------------------------------------------------------------------------------------------------------------------------------------------------------	----------------------------------------------------------------------------------------------------------------------------------------------------------------------------------------------------------------------------------------------------------------------------------------------------------------------------------------------------------------------------------------------------------------------------------------------------------------------------------------------------------------------------------------------------------------------------------------

HYDRAULIC CLOSERS

<p>Tube Length 9"</p> <p>Tube Diameter 1-1/4"</p> <p>Pneumatic Door Closer 18-52 Aluminum 18-53 Black</p> <ul style="list-style-type: none"> • For light weight screen doors. • For wood or metal doors. • For outswinging doors. • Full 90° opening. • Adjustable closing speed. • Factory Lubricated. 	<p>Tube Length 9"</p> <p>Tube Diameter 1-1/4"</p> <p>820 Pneumatic Door Closer 18-103 Aluminum 18-102 Black 18-102W White</p> <ul style="list-style-type: none"> • For light weight screen doors. • For wood or metal doors. • For outswinging doors. • Full 90° opening. • Two hole end plug for summer or winter adjustable latching power. • Adjustable closing speed. • Factory Lubricated. 	<p>Tube Length 12-7/8"</p> <p>Tube Diameter 1"</p> <p>110 Heavy Duty Hydraulic Door Closer 18-99 Aluminum 18-99B Black</p> <ul style="list-style-type: none"> • Hydraulic mechanism provides smooth, constant "no bounce" action. • For wood or metal doors. • For outswinging doors. • Full 90° opening. • Two hole end plug for summer or winter adjustable latching power. • Adjustable closing speed by rotating the tube. • Factory Lubricated. • Aluminum tube assembly. 	<p>Tube Length 10-3/8"</p> <p>Tube Diameter 1"</p> <p>H440 Hydraulic Door Closer 18-55 Aluminum 18-56 Black</p> <ul style="list-style-type: none"> • Hydraulic mechanism provides smooth, constant "no bounce" action. • For wood or metal doors. • For outswinging doors. • Full 90° opening. • Two hole end plug for summer or winter adjustable latching power. • Adjustable closing speed by rotating the tube. • Factory Lubricated. • Aluminum tube assembly.
----------------------------------------------------------------------------------------------------------------------------------------------------------------------------------------------------------------------------------------------------------------------------------------------------------------------------------------------------------------------------------------------------------	-------------------------------------------------------------------------------------------------------------------------------------------------------------------------------------------------------------------------------------------------------------------------------------------------------------------------------------------------------------------------------------------------------------------------------------------------------------------------------------------------------------------	-------------------------------------------------------------------------------------------------------------------------------------------------------------------------------------------------------------------------------------------------------------------------------------------------------------------------------------------------------------------------------------------------------------------------------------------------------------------------------------------------------------------------------------------------------------------------------------------------------	--------------------------------------------------------------------------------------------------------------------------------------------------------------------------------------------------------------------------------------------------------------------------------------------------------------------------------------------------------------------------------------------------------------------------------------------------------------------------------------------------------------------------------------------------------------------------------------------

STRIKE PLATE

**777ST
Replacement Strike Plates**

19-295 Aluminum
19-300 Black
19-298 White

- Replacement strike plate with slotted holes for universal use.
- Packed with installation screws.

DOOR CHAIN

Spring & Chain Door Retainer
19-106

- Wind chain and spring for storm and screen doors.
- Mounting brackets and screws included.
- Helps prevent door closer damage.

STORM DOOR HARDWARE DESIGNER SERIES

ALL
NEW
PRODUCTS!

NEW

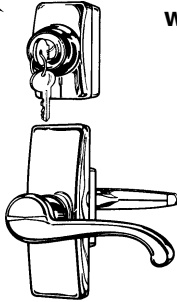

GEORGIAN Lever Latch Set with Keyed Deadbolt

17-89K Black
17-89KW White
Comes furnished
With #555
Inside Latch

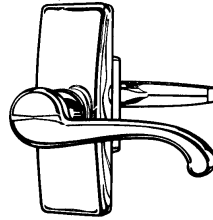

GEORGIAN Lever Latch Only with Integral Deadlock

17-89 Black
17-89W White
Comes furnished
With #555
Inside Latch



- Beautifully designed, classically styled lever handle with an elegantly sculptured escutcheon
- Positive key locking deadbolt for security
- Heavy duty inside handle mechanism
- Strong leveling return spring eliminates lever droop
- Fits doors 3/4" to 1-1/4" thick
- 1-3/4" hole spacing - upper & lower trims
- Install in six 5/16" diameter holes
- For doors with a stile greater than 2"
- Escutcheon width 1-5/8"
- Escutcheon length: upper 2-3/4", lower 4-7/16"
- Lever projection 2-1/8" (from door)
- Backset - variable with several strike options included
- Lever length from center of hub: 4"
- Non-handed, designed to complement both right & left hand doors
- Escutcheon plate included for use with inside latch.

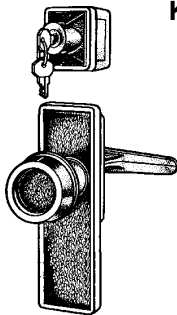

WOODBURY Knob Latch Set with Keyed Deadbolt

17-117 Black
17-118 Bronze
Comes furnished
With #555
Inside Latch

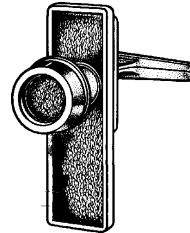

WOODBURY Knob Latch Only with Integral Deadlock

17-137 Black
17-138 Bronze
Comes furnished
With #555
Inside Latch



- Large full sized 2" diameter Woodbury style knob
- Decorative textured outside escutcheon
- Interior deadbolt with 1/2" projection
- Large heavy duty lever handle mechanism inside
- 1-3/4" hole spacing
- Installs in three 5/16" diameter holes
- Escutcheon width: 1-7/8"
- Escutcheon height: 6-3/8"
- Knob projection: 2-1/2"
- Backset - variable with several strike options.

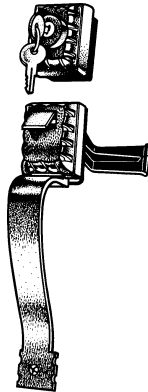

AFTON Thumb Button Latch with Deadbolt

900-13554K Black
Comes furnished
with #333
Inside Latch

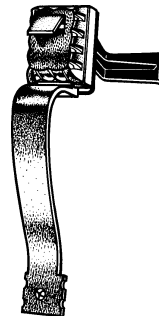

EAGAN Thumb Button Latch Only

900-13554 Black
Comes furnished
with #333
Inside Latch



- Ornately sculptured and textured finish for exclusive look
- Natural thumb latch action
- Positive key locking deadbolt for security
- Escutcheon plate included for use with inside latch
- Full functioning two-piece thumb latch set
- Large, heavy duty push handle mechanism inside
- Massive appearance denotes quality
- For outswinging wood or metal doors
- Fits doors 3/4" to 1-1/4" thick
- 1-3/4" hole spacing - upper & lower trims
- Install in six 5/16" diameter holes
- Handle width 1-3/4"
- Handle length 8-1/4", deadbolt escutcheon length 2-1/4"
- Handle projection 2"
- Backset - variable with several strike options included
- For doors with a stile greater than 2"
- "No Lock Out" feature prevents accidental lock out.

STORM DOOR HARDWARE DESIGNER SERIES



Accents Finish by Wright Products is a new cathodonic electropaint system that provides a beautiful polished brass-look finish for storm door hardware. The Accents finish surpasses brass in chemical, UV and wear resistance tests and will never tarnish or corrode. Accents finish is so durable that Wright Products offers a Limited Lifetime Finish Warranty on all storm door products with the Accents finish.



Graceful, contemporary lever handle and traditionally inspired escutcheon plate.

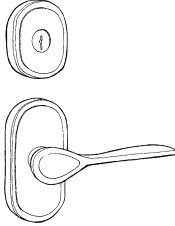

LODI Lever Latch Set With Key Deadbolt

17-132A Accent Finish
Comes Furnished With #555 Black Inside Latch

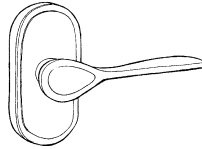

LODI Lever Latch Only with Integral Deadlock

17-132 Accent Finish
Comes Furnished With #555 Black Inside Latch

- Minimum 2" space between storm door & prime door • Minimum backset of 1-1/8" • Minimum inside door stile width of 2"
- Minimum outside stile of 7/8" either side of latch mounting holes • Deadbolt may be installed above or below latch.

The ultimate in both style & function with contemporary round knob & dramatically textured escutcheon plate.

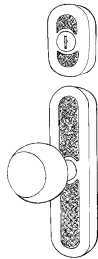

ITASCA Knob Latch Set With Keyed Deadbolt

17-130A Accent Finish
Comes Furnished With #555 Black Inside Latch

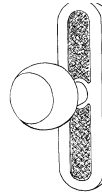

ITASCA Knob Latch Only with Integral Deadlock

17-130 Accent Finish
Comes Furnished With #555 Black Inside Latch

- Minimum 2" space between storm door & prime door • Minimum backset of 1-1/8" • Minimum inside door stile width of 2"
- Minimum outside stile of 3/4" either side of latch mounting holes • Deadbolt may be installed above or below latch.

Beautifully designed, classically styled lever handle with sculptured escutcheon plate.

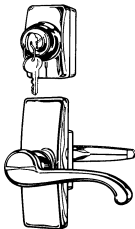

GEORGIAN Lever Latch Set With Keyed Deadbolt

17-89KBR Accent Finish
Comes Furnished With #555 Black Inside Latch

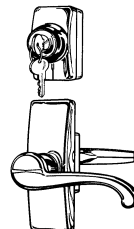

GEORGIAN Lever Latch Only with Integral Deadlock

17-89BR Accent Finish
Comes Furnished With #555 Black Inside Latch

- Minimum 2" space between storm door & prime door • Minimum backset of 1-1/8" • Minimum inside door stile width of 2"
- Minimum outside stile of 7/8" either side of latch mounting holes • Deadbolt may be installed above or below latch.



QUINCY Push Button Latch Set

Elegant, traditionally styled handle designed for storm doors with narrow stiles. Deadbolt is key operated outside, thumb turn inside.

17-127 Accent Finish
Comes Furnished With #555 Black Inside Latch

- Minimum 1-1/2" space between storm door & prime door • Minimum backset of 3/4" • Minimum inside door stile width of 1-5/16" • Minimum outside stile of 7/8" either side of latch mounting holes.



CUMBERLAND Push Button Latch

Exact replacement for a wide variety of storm door latches.

17-134 Accent Finish
Comes Furnished With #333 White Inside Latch

- Minimum 1-1/2" space between storm door & prime door • Minimum backset of 3/4" • Minimum inside door stile width of 1-5/16" • Minimum outside stile of 9/16" either side of latch mounting holes.

Latch #555 & Deadbolt #123

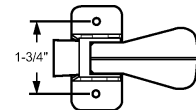

17-140 Latch Black

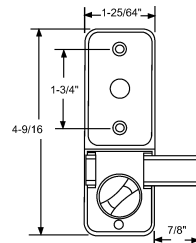

17-160 Deadbolt Black

TOLL FREE 800-352-0800

2003, SBI®

strybug

xv

Return to Table of Contents

ARCHITECTURAL SPECIALTIES SCREEN HARDWARE

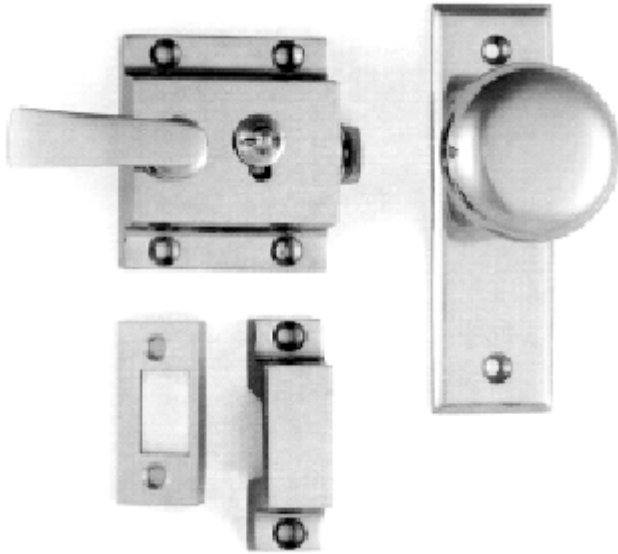

17-155

The newly redesigned Model 17-155 is a solid brass screen or storm door latchset. The lock case, escutcheon plate and strike are hot-forged and precision machined for smooth operation. The spring mechanism is stainless steel. The lever and threaded spindle are hot-forged in one piece for added strength, and the knob is turned from brass bar stock. The latchset is supplied with an angle strike and a rim strike. Backset is 1-9/16". The threaded spindle allows easy adjustment for door thicknesses of 1-1/8" to 1-3/4". Thinner doors can be accommodated by cutting the spindle.

Dimensions:

Case 2-1/4" X 2" Back Plate 1-1/4" X 4" Knob 1-5/8" dia.
Overall Depth: Lever side 1-7/16" Knob side 1-1/2"

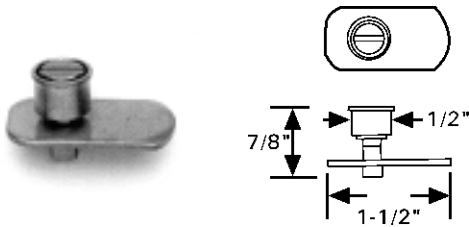

19-319

The Model 19-319 cam fastener is a solid brass assembly designed to fasten wood storm or screen inserts into a combination door or other frame. The standard finish is unlacquered.

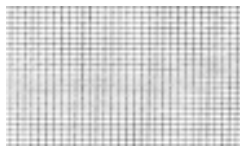

- 69-29BR 24" x 100'
- 69-65BR 36" x 100'
- 69-77BR 48" x 100'

Bronze Insect Screening

Our heavy-duty solid bronze insect screening is designed for fabrication of high quality window screens and screen doors. It is woven of .011" solid bronze wire into an 18 X 14 mesh. Available from our stock for immediate shipment in 100' rolls, 36", 48", or 60" in width.