

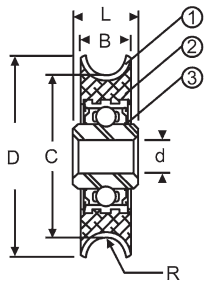

Precision Bearing Roller Assembly for Patio Sliding Glass Door



Part #	D	C	d	B	R	L
11-212	1-1/2"	1-1/4"	1/4"	5/16"	1/8"	3/8"
11-214	1-1/4"	1"	1/4"	5/16"	1/8"	3/8"

1. Outer Ring - Stainless Steel
2. Reinforced Nylon
3. Precision Bearing

ABB Series Precision Bearing Stainless Steel Wheels

Completely new design that establishes a new level of quality for Patio Door Rollers. Design Highlights:

- Ideal for coastal applications
- Extremely smooth rolling
- Less operating force (motion to open/close)
- Less noise and vibrations
- Better corrosion resistance
- The Precision Bearing is factory greased and completely sealed
- The outer ring, that is the rolling surface of the wheel, is made of Stainless Steel to avoid any rust formation between the wheel and the track.
- Using composite nylon, the Precision Bearing is assembled with the outer ring by an injection molding process.

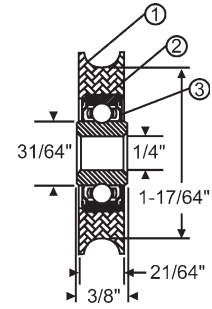

Part #	Wheel
11-227	1-1/2"

1. Outer Ring - Nylon
2. Reinforced Nylon
3. Precision Bearing

MBB Series Precision Bearing Nylon Wheels

This is an upgraded Nylon wheel that is assembled with a precision bearing as in the ABB Series. The Nylon tire is injected with fiber glass reinforced Nylon. The competitive advantages of this wheel are similar to those for the ABB Series,

- Extremely smooth rolling
- Less operating force (motion to open/close)
- Less noise and vibrations
- Higher Load capacity of 65 Lbs. per wheel (compared to 45 Lbs. per wheel on a regular Nylon wheel)
- The Precision Bearing is factory greased and completely sealed

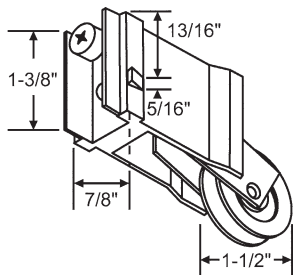

Part #	Size	Outer Ring
9-257SPB	1-1/2"	Stainless Steel
9-257NPB	1-1/2"	Nylon

Pan Am

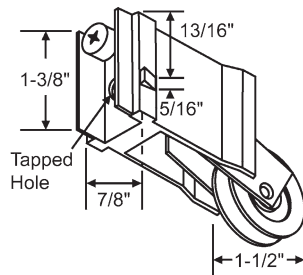

Part #	Size	Outer Ring
9-457SPB	1-1/2"	Stainless Steel
9-457NPB	1-1/2"	Nylon

Pan Am/AAA

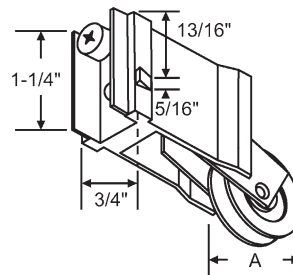

Part #	A	Outer Ring
9-247-1.25SPB	1-1/4"	Stainless Steel
9-247SPB	1-1/2"	Stainless Steel
9-247NPB	1-1/2"	Nylon

Yale Ogron

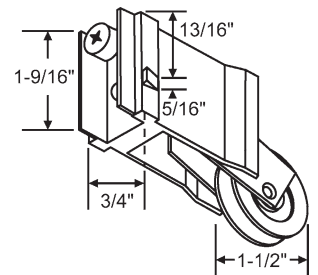

Part #	Size	Outer Ring
9-249SPB	1-1/2"	Stainless Steel
9-249NPB	1-1/2"	Nylon

Weatherite/Lawson

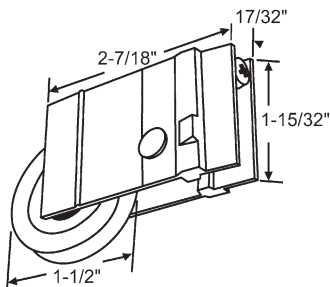

Part #	Size	Outer Ring
9-364SPB	1-1/2"	Stainless Steel
9-364NPB	1-1/2"	Nylon

Lawson/Wallace

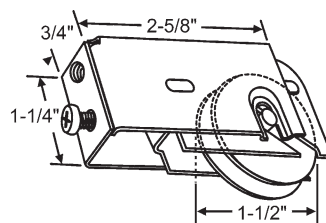

Part #	Size	Outer Ring
9-392SPB	1-1/2"	Stainless Steel

Croft

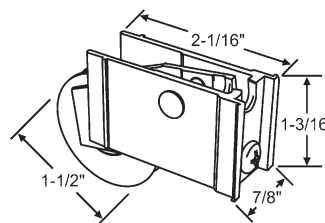

Part #	Size	Outer Ring
9-330SPB	1-1/2"	Stainless Steel

Security

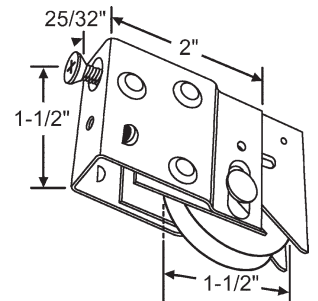

Part #	Size	Outer Ring
9-366SPB	1-1/2"	Stainless Steel

Binnings/Pan Am

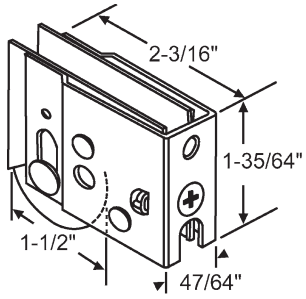

Part #	Size	Outer Ring
9-338SPB	1-1/2"	Stainless Steel

Harcar/Keller/Pan Am

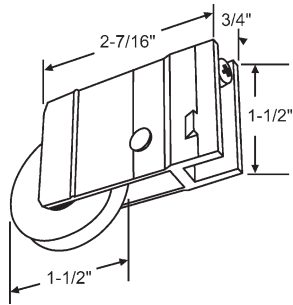

Part #	A	Outer Ring
9-453SPB	1-1/2"	Stainless Steel

Lawson

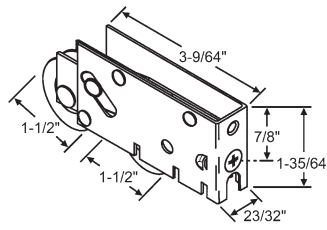

Part #	Size	Outer Ring
900-22693-SPB	1-1/2"	Stainless Steel
900-22693-NPB	1-1/2"	Nylon

PGT/Kinco

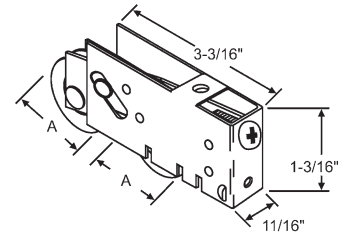

Part #	A	Outer Ring
9-443-1.25SPB	1-1/4"	Stainless Steel
9-443SPB	1-1/2"	Stainless Steel
9-443NPB	1-1/2"	Nylon

Nu-Air

Your Roller Assembly Not Listed?

Call your sales representative and find out if we can furnish your particular patio door roller assembly with our Precision Bearing Roller. We have machine shop capabilities where we can supply many patio door roller assemblies equipped with our new Precision Bearing Roller.