

Toilet Partition Hardware

Concealed and Surface Mounted Latches

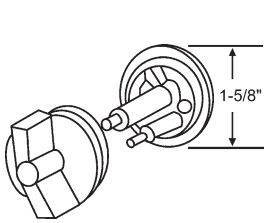

91-8
Used with 91-129 Housing
American Metal

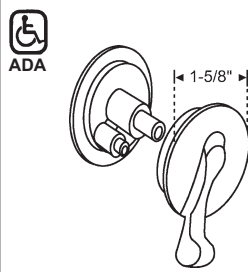

91-330
Used with 91-129 Housing

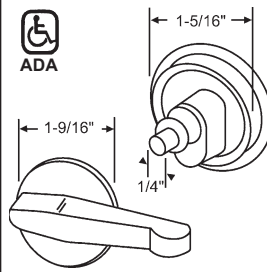

91-84
Sanymetal

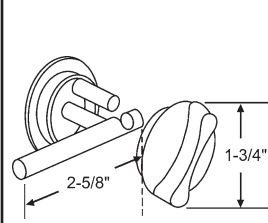

91-130
For 1" Laminated Door

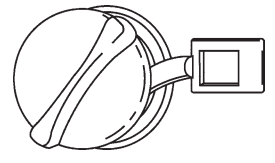

91-131
With Flat Tip Bar. For 1" Steel Door

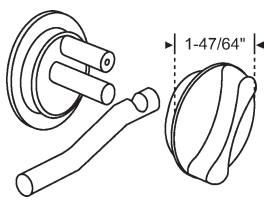

91-198
For 1" Steel Door

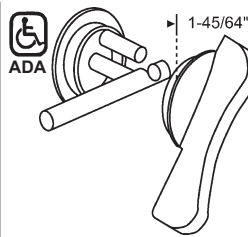

91-209
For 1" Laminated Door

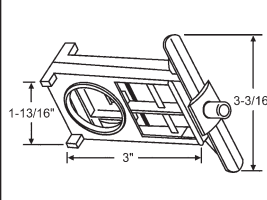

91-129
Zinc Die Cast - Unplated

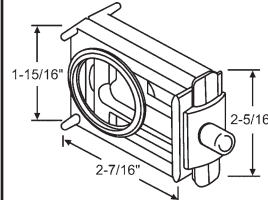

91-187
Zinc Die Cast - Unplated

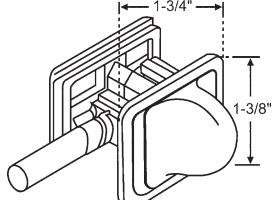

91-292
For 1" Steel Door

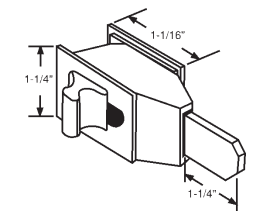

900-18069
With Indicator. For 1" Steel Door

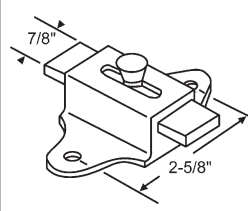

91-83

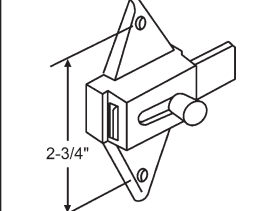

91-79

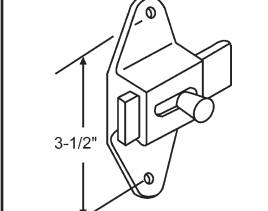

91-4

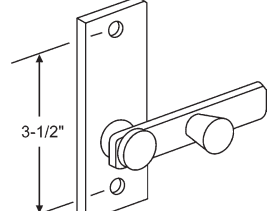

91-80

Chrome Plated Door Pulls, Hooks and Door Stops

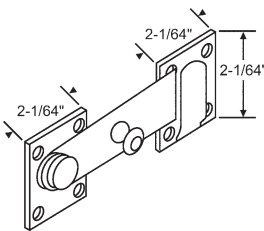

900-20480

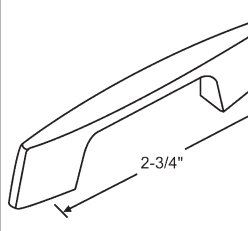

91-125
Mounting Holes Tapped 8-32

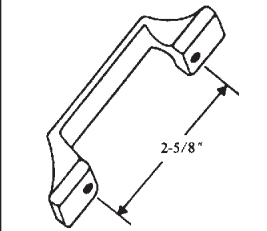

91-90
Mounting Holes Tapped 10-24

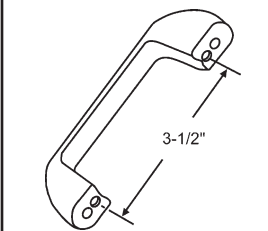

91-9
Mounting Holes Tapped 10-24

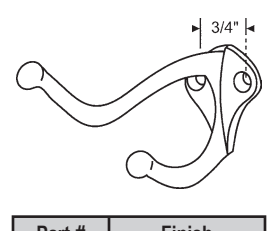

Part #	Finish
91-7	Chrome Plated
91-7BP	Brass Plated

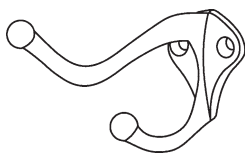

91-7J
Heavy Duty. 7/32" Hole Diameter

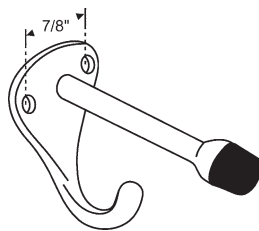

91-6
Coat Hook with Bumper
7/32" Hole Diameter

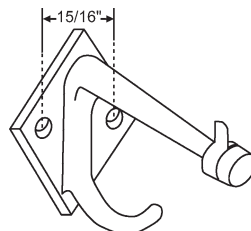

91-255
1/4" Hole Diameter

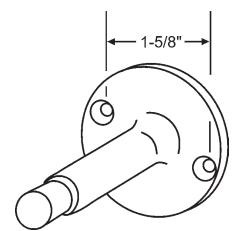

91-10
2" High

Toilet Partition Hardware

Chrome Plated Keepers and Strikes for 1-1/4" Round and Square Posts

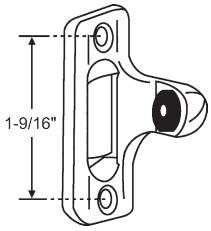

91-290

Inswing/Outswing for Concealed Latch with Flat Bar

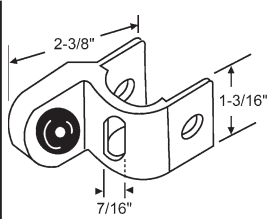

91-5

Inswing/Outswing for Concealed Latch with Round Bar

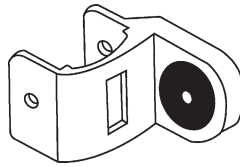

91-134

Inswing/Outswing for Concealed Latch with Flat Bar

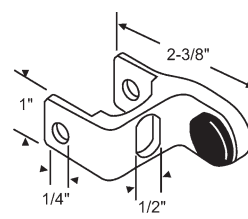

91-87

Inswing/Outswing for Concealed Latch

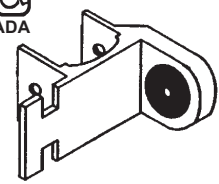

91-253

Inswing for Throw Latch. Emergency Access

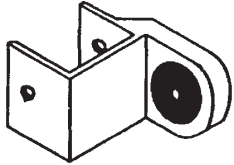

91-137

Outswing for Slide Latch

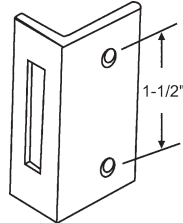

900-10535

Inswing for Slide Latch, Chrome

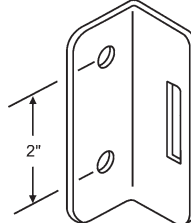

91-89

Inswing for Slide Latch

Sanymetal

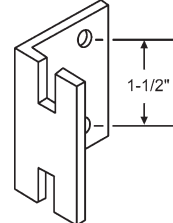

91-81

Inswing for Throw Latch. Emergency Access

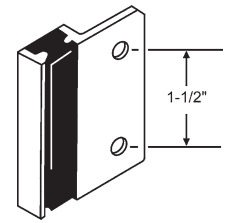

91-82

Inswing/Outswing for Slide Latch

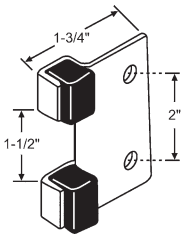

91-88

Inswing/Outswing Strike
Sanymetal

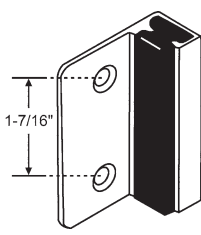

91-141

Outswing for Slide Latch

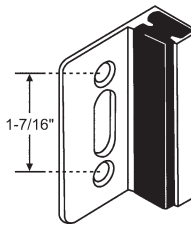

91-140

Inswing/Outswing for Concealed Latch

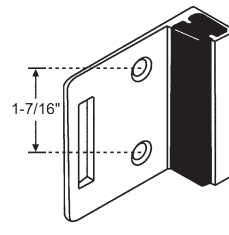

91-135

Inswing for Slide Latch

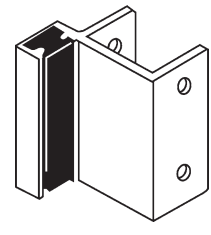

91-78

Outswing for Slide Latch

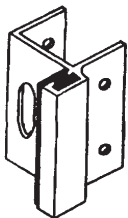

91-133

Inswing/Outswing for Concealed Latch

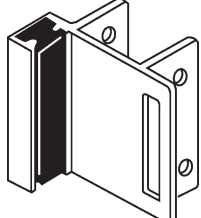

91-26

Inswing for Slide Latch

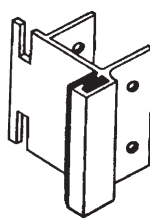

91-132

Inswing for Throw Latch. Emergency Access

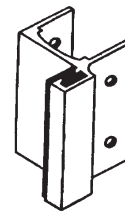

91-217

Outswing for Slide Latch

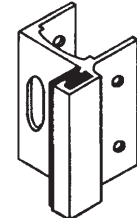

91-55

Inswing/Outswing for Concealed Latch with Round Bar

Chrome Plated Wrap Around Gravity Pivot Hinges for 1-1/4" Round and Square Posts

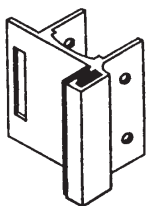

91-237

Outswing for Slide Latch

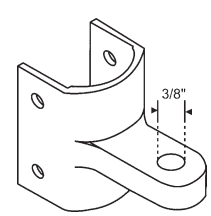
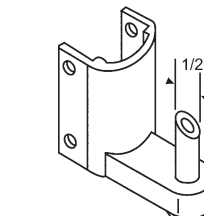
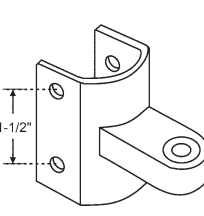
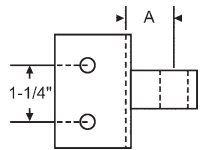

Part #	A
91-2	1-5/64"

Flushmetal

Part #	A
91-3	1-5/32"

Flushmetal

Part #	A
91-85	1-1/16"

Sanymetal

Toilet Partition Hardware

Chrome Plated Wrap Around Gravity Pivot Hinges for 1-1/4" Round and Square Posts

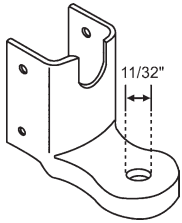

Part #	A
91-86	1-1/16"

Sanymetal

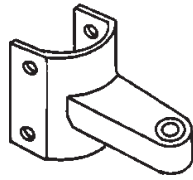

Part #	A
91-183	1-25/64"

General/Knickerbocker

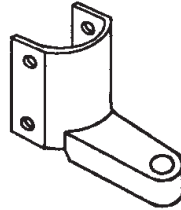

Part #	A
91-182	1-25/64"

General/Knickerbocker

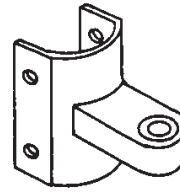

Part #	A
91-186	1-1/16"

Ampco/Metpar

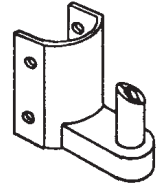

Part #	A	Description
91-185A	1-7/64"	with Pintle
91-185	1-7/64"	without Pintle

Ampco/Metpar

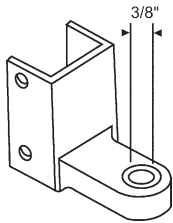

Part #	A
91-24	1-17/64"

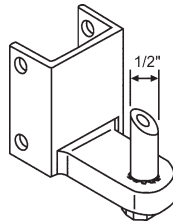

Part #	A
91-25	1-17/64"

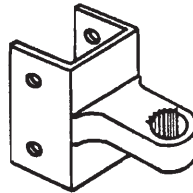

Part #	A
91-240	1-19/64"

Top and Bottom Hinge

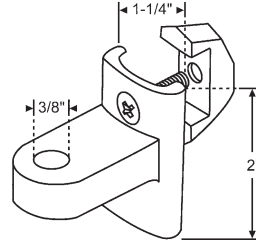

Use: 91-85

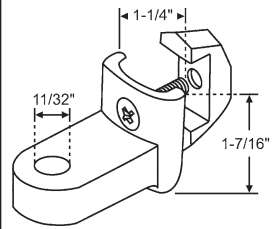

Use: 91-86

Surface Mounted Gravity Hinge

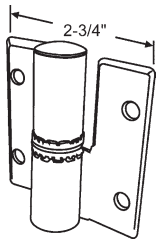

91-28

Round Barrel Hinge set for LH Inswing or RH Outswing. Chrome Plated. Includes 8 One Way Screws and 8 Barrel Nuts

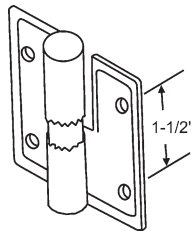

91-29

Round Barrel Hinge set for RH Inswing or LH Outswing. Chrome Plated. Includes 8 One Way Screws and 8 Barrel Nuts

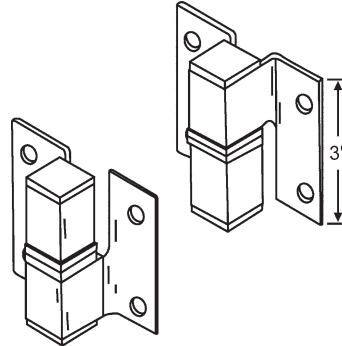

91-173

Square Barrel Hinge set for RH Inswing or LH Outswing. Cast Stainless Steel. Satin Finish

91-199

Square Barrel Hinge set for LH Inswing or RH Outswing. Cast Stainless Steel. Satin Finish

Chrome Plated Wall Brackets

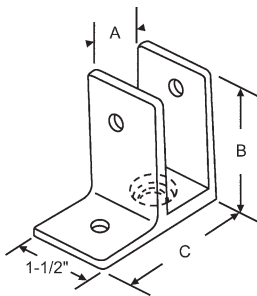

Part #	A	B	C
91-15	1"	2-1/2"	2-21/32"
91-16	1-1/4"	2-1/2"	2-3/4"
91-288	1-1/4"	3-1/2"	2-3/4"

One Ear

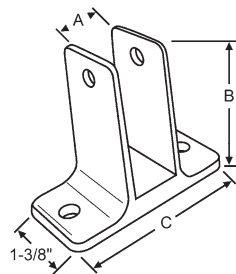

Part #	A	B	C
91-323	3/4"	2-1/2"	3"

Two Ears

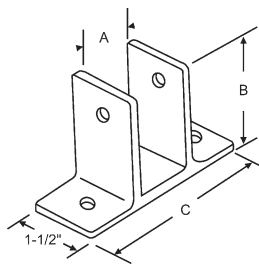

Part #	A	B	C
91-17	1"	2-1/2"	4"
91-97	1"	3-1/2"	4"
91-18	1-1/4"	2-1/2"	4"

Two Ears

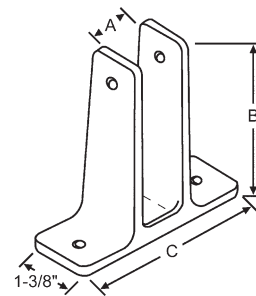

Part #	A	B	C
91-160	1"	3-1/2"	4"
91-161	1-1/4"	3-1/2"	4"

Screen Brackets

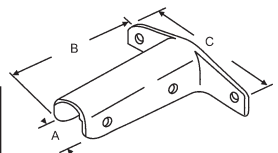

Part #	A	B	C
91-159	1"	12"	7"
91-11	1-1/4"	6"	6-1/4"

Wing Brackets

TOLL FREE: 800-352-0800

2011 PGI©

strybuc
INDUSTRIAL

357

Toilet Partition Hardware

Chrome Plated U - Brackets

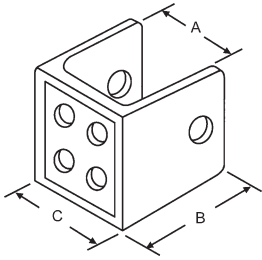

Part #	A	B	C
91-76	7/8"	1-3/8"	1-5/32"
91-12	1"	1-3/8"	1-1/4"
91-167	1-1/4"	1-3/8"	1-1/2"

Replacement Pilaster Shoes

Square Edge 1-1/4" Thick Pilaster Shoes
Open Front w/Holes. 22 Gauge Stainless Steel. Satin Finish

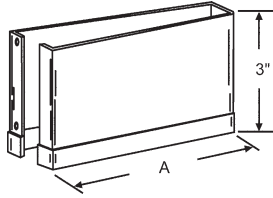

Part #	"A"
91-31	2"
91-33	3"
91-35	4"
91-37	5"
91-39	6"
91-41	7"
91-43	8"
91-45	10"
91-47	12"

Round Edge 1-1/4" Thick Pilaster Shoes
Open Front w/Holes. 22 Gauge Stainless Steel. Satin Finish

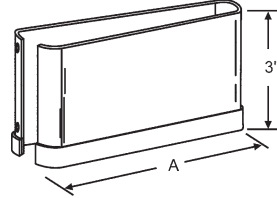

Part #	"A"
91-30	2"
91-32	3"
91-34	4"
91-36	5"
91-38	6"
91-40	7"
91-42	8"
91-44	10"
91-46	12"

Door Inserts

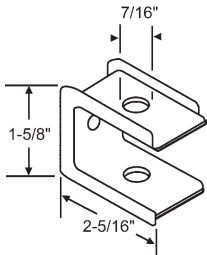

91-72

Top - for 1" Square Edge Door
Chrome Plated

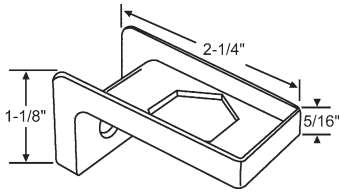

91-117

Bottom - for 1" Square Edge Door
Chrome Plated

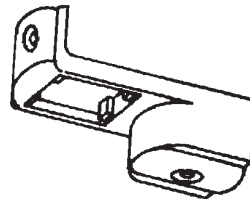

91-252

Bottom - for 1" Round Edge
Metal Door. Unplated

Flushmetal

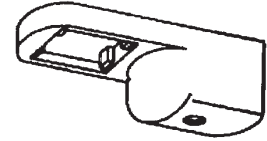

900-14906

Bottom - for 1" Round Edge Metal Door.

Ampco/Metpar

Cams, Pintles and Hinge Pins

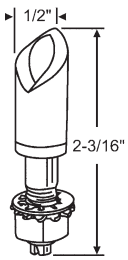

91-102B

Used with 91-114 and 91-191

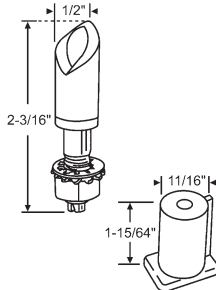

91-102

Set

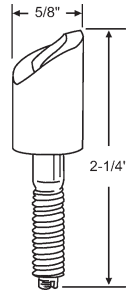

91-148

Used with 91-113, 91-190
and 91-189

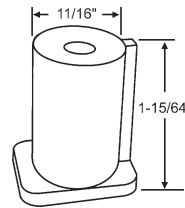

91-191

White Plastic. Fits Insert 91-73

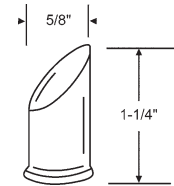

91-114

White Plastic. Fits Insert 91-153

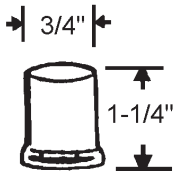

91-113

White Plastic. Fits Insert 91-117

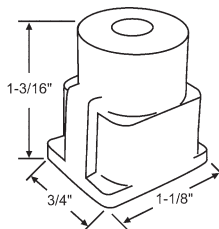

91-189

White Plastic

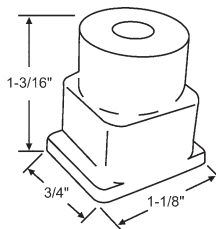

91-190

White Plastic



91-313

Nylon
Hadrian



91-314

Hadrian

Toilet Partition Hardware

Cams, Pintles and Hinge Pins

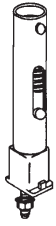

91-152

Metpar

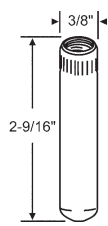

91-96

Plastic
Sanymetal

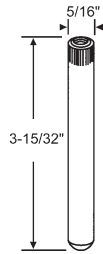

91-1

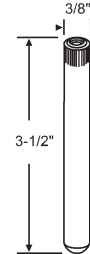

91-71

Hinge Bracket for Plastic
Laminated Pilasters



91-261

General

Chrome Plated Alcove Clips, Head Rail, End Plugs and Brackets

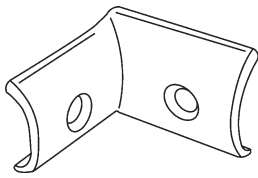

91-328

For 1" to 1-1/4" Post. Right Angle
Curved Molding

Flush Metal

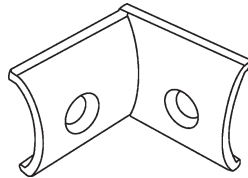

91-264

Alcove Right Angle
Curved Molding

Metpar

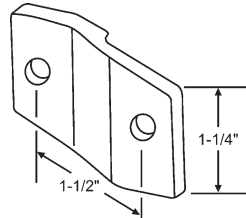

91-70

Alcove 1-1/4" Offset (1/8" per
side). For all Size Posts

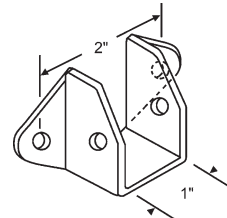

91-13

Headrail Bracket

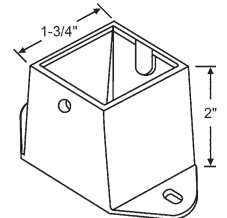

91-21

Pilaster Shoe for 1-3/4"
Square Tube

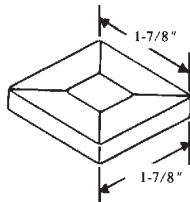

91-20

1-3/4" Nylon Square Post Cap

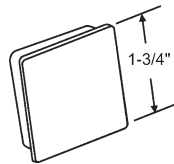

91-116

1-3/4" Nylon Square Post Plug

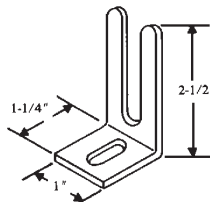

91-22

Floor Bracket

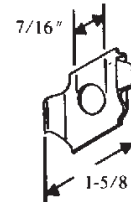

91-23

Spring Clip

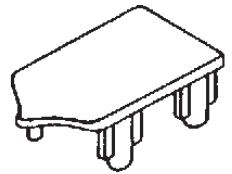

91-63

Anti-Grip End Plug for all Size
Handrails

One-Way Screw Remover

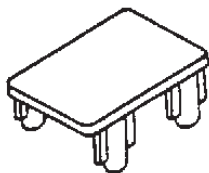

91-64

Rectangular Endplug
for 1" Handrail

If you've tried to remove One-Way Tamper-Proof Screws from toilet partition, locks, fixtures and assemblies.... you know the frustration involved. NO MORE DRILLING, POUNDING, PULLING, OR CHISELING... that wastes time, bruises knuckles and causes costly hardware damage. Highly praised by thousands of locksmiths, maintenance and service personnel, contractors and other professionals as a VALUABLE TOOL NEEDED FOR YEARS!

Part #	Screw Size
59-15	6-8
59-16	8-10
59-17	12-14

Three sizes available to fit
all one-way screws.

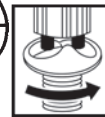
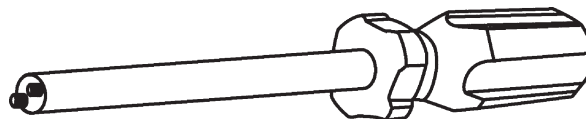

Easy to Use

Works like an ordinary
screwdriver. "No slip"
tip design provides
maximum holding power
until screw is removed.

Chrome Plated Toilet Partition Fasteners

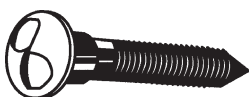

Part #

Screw Size

20-291 10-24 Thread x 15/16" Long

20-187 10-24 Thread x 1-3/16" Long

20-185 8-32 Thread x 1-3/8" Long

One Way Screws



Part #

Screw Size

20-293 10-24 Thread x 5/8" Long

20-186 10-24 Thread x 1/2" Long

20-186US 8-32 Thread x 1/2" Long (Not Slotted)

Barrel Nut



Part #

Screw Size

20-366 #10 x 3/4" Long

20-204 #10 x 1" Long

20-362 #10 x 5/8" Long

Self Tapping Screws

TOLL FREE: 800-352-0800

2011 PGI©

strybug
THE PLUMBER'S FRIEND

359