

Screen Hardware

Custom Made Window Screens

CUSTOM MADE STANDARD ROLL FORM ALUMINUM WINDOW SCREEN ORDER FORM

Account# _____

Page# ____ of ____

Sold To: _____

Ship To: _____

Salesman _____ Supervisor _____ Purchase Order# _____

Date _____ Quoted By _____ Customer # _____

STEP 1 Measurement

_____ " Width x _____ " Height

Note: On all screen frames screen measurements must be box to box.

Note: Maximum screen size is 45" x 80". Cannot process orders for any screens larger than 45" x 80".

STEP 2 Identify Frame part # _____

STEP 3 Select frame finish.

Mill _____ White _____ Almond _____ Beige _____
Bronze _____ Other _____

STEP 4 Select wire.

Charcoal Fiberglass (Standard) _____ Gray Fiberglass _____
Bright Aluminum _____ Charcoal Aluminum _____
Pet Screen _____ Other _____

STEP 5 Crossbrace location

Required _____ Not Required _____

Horizontal: _____ inches up from the bottom

Vertical: _____ inches from the right rail

STEP 6 Type of Corner Keys

Plastic External Square Cut (Standard) _____

Plastic Internal Mitered _____

Plastic External Mitered (Andersen Style) _____

Note: Unless otherwise specified, all custom made window screens are manufactured with external plastic corner keys.

STEP 7 Hardware: Required _____ Not Required _____

**Show Hardware Locations
(Inside Looking Out / Spline on Outside)**

STEP 8 Measure location of hardware and specify on drawing.

Always determine hardware location from the end of corner to either center or pivot point depending on type of hardware.

Fill out the positioning of the hardware below.

Location	Quantity	Number	Position - Number of inches from end (tip or corner)
Installed on HEAD RAIL			
Installed on SILL RAIL			
Installed on LEFT RAIL			
Installed on RIGHT RAIL			

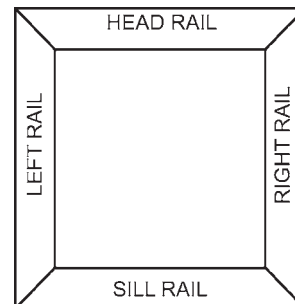

Part#	Quantity (see note below)	Size	Price Each	Amount
990-999		" width X " height		
890-999-1		Window Screen Packaging Charge	\$ _____	
Note: Minimum 2 screens per size & color			TOTAL	
Note: On all screen frames screen measurements must be box to box.			FREIGHT	
Note: Maximum screen size is 45" x 80". Cannot process orders for any screens larger than 45" x 80".				

STEP 9 All Custom made window screen orders will not be processed without customer's signature verifying acceptance of our terms and conditions of order.

I understand that this material is not regular stock, but custom made to specifications as stated above. I understand and accept the condition that this material is NON-RETURNABLE and NON-CANCELABLE. A packaging charge per screen will be assessed for quantities less than 10 of a size. IT IS THE RESPONSIBILITY OF THE CUSTOMER TO INSPECT FOR DAMAGE, AND MAKE THE CLAIM WITH THE CARRIER, AS WE ARE NOT RESPONSIBLE FOR DAMAGE.

Please Note: For all truck deliveries there is a minimum floor charge. There is an additional charge for residential deliveries.

Signature of Authorized Buyer _____ Buyer Phone _____ - _____

Title _____

FAX THIS COMPLETED FORM TO: 610-534-3202

Custom Made Window Screens

ROLLED FORMED ALUMINUM FRAME SIZES

See Following Pages for Components

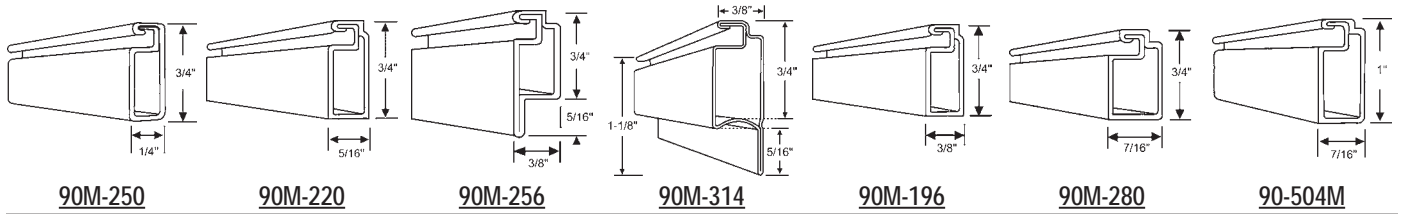

Aluminum Frame Accessories

.019 GAUGE

Part #	Color
90M-250	Mill
90M-251	White
90M-252	Dark Bronze

5/32" PLUNGER ASSEMBLIES

Part #	Cap Color
90-635	White
90-635B	Black

Flip Type

Part #	Cap Color
90-635FT	White
90-635BFT	Black

FIXED PIN

900-21792
5/32"x1-1/8"

HAIR PIN CLIP

90-127

TENSION SPRING

900-17211

LOOP LATCH

90-103X
Spline Type

Part #	Color
900-12883	Clear
900-12883B	Black

Nylon - Lays Flat

PULL TABS

Part #	Description
90-633	Black vinyl flexible
90-634	Black vinyl rigid
90-634G	Gray vinyl rigid

Part #	Color
90-118	Mill
90-118WH	White

Aluminum

.019 GAUGE

Part #	Color
90M-220	Mill
90M-221	White
90M-222	Dark Bronze

5/32" PLUNGER ASSEMBLIES

Part #	Cap Color
90-635	White
90-635B	Black

Flip Type

Part #	Cap Color
90-635FT	White
90-635BFT	Black

7/32" PLUNGER ASSEMBLIES

Part #	Cap Color
900-9850	White
900-9850B	Black

Flip Type

Part #	Cap Color
900-9850FT	White
900-9850BFT	Black

FIXED PIN

Part #	Description
900-21792	5/32"x1-1/8"
900-21747	7/32"x1-1/8"

BUTTERFLY LATCH

90-506

LOOP LATCH

90-103X
Spline Type

HAIR PIN CLIP

90-127

SWIVEL CLIP

Part #	Color
90-380B	Black
90-380WH	White

Screen Hardware

Custom Made Window Screens

CORNER SPRING

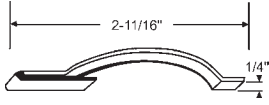

90-498

TENSION SPRING

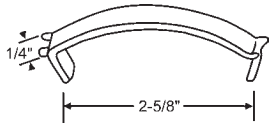

16-158

PULL TABS

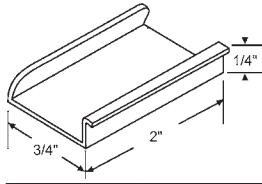

Part #	Color
90-118	Mill
90-118WH	White

Aluminum

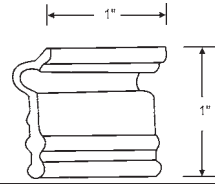

Part #	Description
90-633	Black vinyl flexible
90-634	Black vinyl rigid
90-634G	Gray vinyl rigid

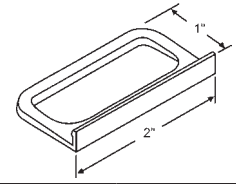

Part #	Color
900-12883	Clear
900-12883B	Black

Nylon - Lays Flat

.019 GAUGE

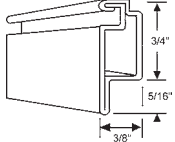

Part #	Color
90M-256	Mill
90M-257	White
90M-258	Dark Bronze

Can be used with frame
90M-196, 90M-197 & 90M-198

5/32" PLUNGER ASSEMBLIES

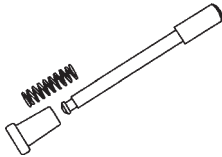

Part #	Cap Color
90-635	White
90-635B	Black

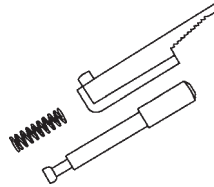

Part #	Cap Color
90-635FT	White
90-635BFT	Black

Flip Type

FIXED PIN

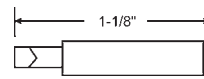

900-21792
5/32"x1-1/8"

HAIR PIN CLIP

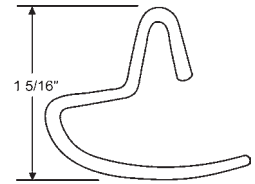

90-127

LOOP LATCH

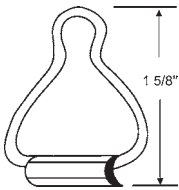

90-103X
Spline Type

POINTER LATCH

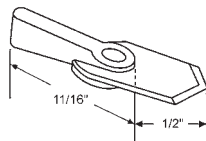

Part #	Color
900-9823	Black
900-9823W	White

CORNER SPRING

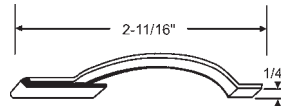

90-498

TENSION SPRING

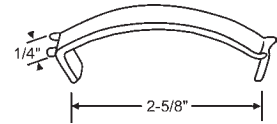

16-158

PULL TABS

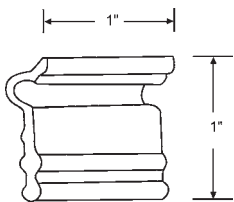

Part #	Description
90-633	Black vinyl flexible
90-634	Black vinyl rigid
90-634G	Gray vinyl rigid

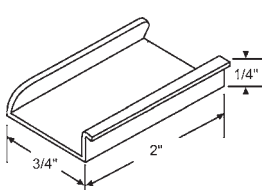

Part #	Color
90-118	Mill
90-118WH	White

Aluminum

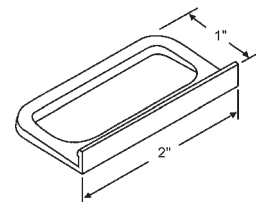

Part #	Color
900-12883	Clear
900-12883B	Black

Nylon - Lays Flat

.019 GAUGE

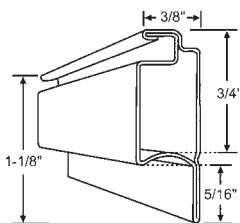

Part #	Color
90M-314	White
90M-313AD	Almond
90M-315	Bronze

A Good Substitute For Bayform
Series B38LI Frame

5/32" PLUNGER ASSEMBLIES

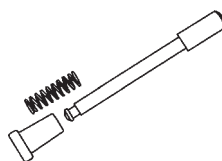

Part #	Cap Color
90-635	White
90-635B	Black

Flip Type

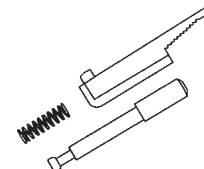

Part #	Cap Color
90-635FT	White
90-635BFT	Black

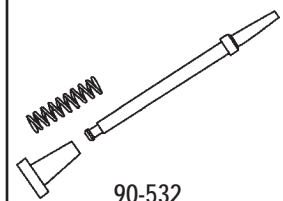

90-532

Custom Made Window Screens

.019 GAUGE

Part #	Color
90M-196	Mill
90M-197	White
90M-198	Dark Bronze

5/32" PLUNGER ASSEMBLIES

Part #	Cap Color
90-635	White
90-635B	Black

7/32" PLUNGER ASSEMBLIES

Part #	Cap Color
900-9850	White
900-9850B	Black

Flip Type

FIXED PIN

Part #	Description
900-21792	5/32"x1-1/8"
900-21747	7/32"x1-1/8"

BUTTERFLY LATCH

90-506

LOOP LATCH

90-103X
Spline Type

HAIR PIN CLIP

90-127

CORNER SPRING

90-498

TENSION SPRING

16-158

PULL TABS

Part #	Color
900-12883	Clear
900-12883B	Black

Nylon - Lays Flat

Part #	Color
90-118	Mill
90-118WH	White
90-118BZ	Bronze

Aluminum

Part #	Description
90-633	Black vinyl flexible
90-634	Black vinyl rigid
90-634G	Gray vinyl rigid

Part #	Color
90-376	Black
90-376GY (1831A)	Gray

Vinyl

.019 GAUGE

Part #	Color
90M-280	Mill
90M-281	White
90M-282	Dark Bronze

.024 GAUGE

Part #	Color
90M-286	Mill
90M-287	White
90M-288	Dark Bronze

5/32" PLUNGER ASSEMBLIES

Part #	Cap Color
90-635	White
90-635B	Black

7/32" PLUNGER ASSEMBLIES

Part #	Cap Color
90-635FT	White
90-635BFT	Black

Flip Type

Part #	Cap Color
900-9850	White
900-9850B	Black

7/32" PLUNGER ASSEMBLIES

Part #	Cap Color
900-9850FT	White
900-9850BFT	Black

Flip Type

HAIR PIN CLIP

90-127

JIFFY HANGER

90-389
Mill

FIXED PIN

Part #	Description
900-21792	5/32"x1-1/8"
900-21747	7/32"x1-1/8"

Custom Made Window Screens

CUSTOM MADE EXTRUDED ALUMINUM WINDOW SCREEN ORDER FORM

Account# _____

Page# ____ of ____

Sold To: _____

Ship To: _____

Salesman _____ Supervisor _____ Purchase Order# _____

Date _____ Quoted By _____ Customer # _____

STEP 1 Measurement

_____ " Width x _____ " Height

Note: On all screen frames screen measurements must be box to box.

Note: Maximum screen size is 45" x 80". Cannot process orders for any screens larger than 45" x 80".

STEP 2 Identify Frame part

Head Rail # _____

Right Rail # _____

Left Rail# _____

Sill Rail # _____

Note: No need to specify corner. Proper corner will be applied based on frame selected.

STEP 3 Select frame finish.

White _____ Beige _____ Bronze _____

STEP 7 Measure location of hardware and specify on drawing.

Always determine hardware location from the end of corner to either center or pivot point depending on type of hardware.

Fill out the positioning of the hardware below.

Location	Quantity	Number	Position - Number of inches from end (tip or corner)
Installed on HEAD RAIL			
Installed on SILL RAIL			
Installed on LEFT RAIL			
Installed on RIGHT RAIL			

STEP 4 Select wire.

Charcoal Fiberglass (Standard) _____ Gray Fiberglass _____

Bright Aluminum _____ Charcoal Aluminum _____

Pet Screen _____ Other _____

STEP 5 Crossbrace location

Required _____ Not Required _____

Horizontal: _____ inches up from the bottom

Vertical: _____ inches from the right rail

STEP 6 Hardware: Required _____ Not Required _____

**Show Hardware Locations
(Inside Looking Out / Spline on Outside)**

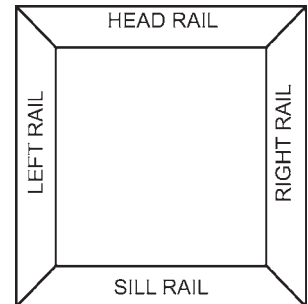

Part#	Quantity (see note below)	Size	Price Each	Amount
990E-999		" width X " height		
890-999-1		Window Screen Packaging Charge	\$ _____	
Note: Minimum 2 screens per size & color Note: On all screen frames screen measurements must be box to box. Note: Maximum screen size is 45" x 80". Cannot process orders for any screens larger than 45" x 80".			TOTAL	
			FREIGHT	

STEP 8 All Custom made window screen orders will not be processed without customer's signature verifying acceptance of our terms and conditions of order.

I understand that this material is not regular stock, but custom made to specifications as stated above. I understand and accept the condition that this material is NON-RETURNABLE and NON-CANCELABLE. A packaging charge of per screen will be assessed for quantities less than 10 of a size. IT IS THE RESPONSIBILITY OF THE CUSTOMER TO INSPECT FOR DAMAGE, AND MAKE THE CLAIM WITH THE CARRIER, AS WE ARE NOT RESPONSIBLE FOR DAMAGE.

Please Note: For all truck deliveries there is a minimum floor charge. There is an additional charge for residential deliveries.

Signature of Authorized Buyer _____ Buyer Phone _____ - _____

Title _____

FAX THIS COMPLETED FORM TO: 610-534-3202

TOLL FREE: 800-352-0800

2011 PGI©

strybuc
FINE LULU STATE

255

Screen Hardware

Custom Made Extruded Window Screens

Group 1 - .050 GAUGE

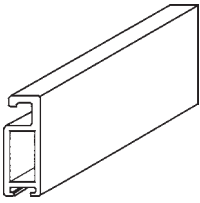

90-1030
(5/16" x 3/4" Box) Plain

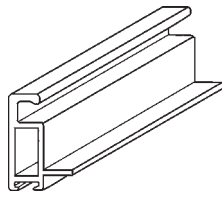

90-1031
(5/16" x 3/4" Box) w/Stopleg

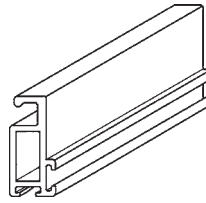

90-1032
(5/16" x 3/4" Box) w/Woolpile

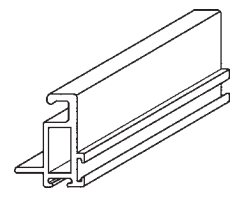

90-1033
(5/16" x 3/4" Box) w/Stopleg
& Woolpile

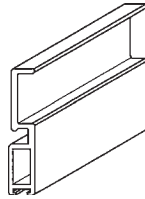

90-1034
(5/16" x 3/4" Box) w/Lift Rail

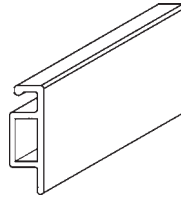

90-1049
(5/16" x 3/4" Box x 5/16"
Flange) For Interior Applications

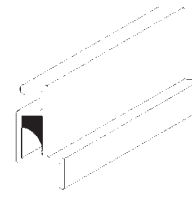

90-1050
(5/16" x 3/4" Box x 5/16" Flange) with
Offset. For Interior Applications

Group 2 - .050 GAUGE

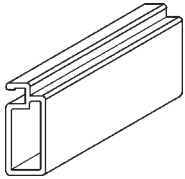

90-1035
(3/8" x 7/8") Plain

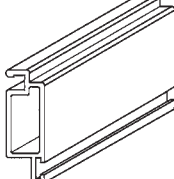

90-1037
(3/8" x 7/8")
w/Woolpile

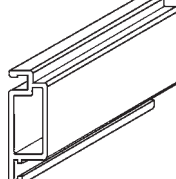

90-1038
(3/8" x 7/8")
w/Reverse Woolpile

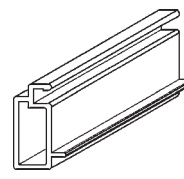

90-1036
(3/8" x 7/8")
w/Stopleg

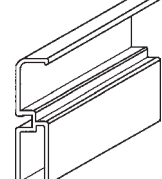

90-1039
(3/8" x 7/8")
w/Lift Rail

Group 3 - .050 GAUGE

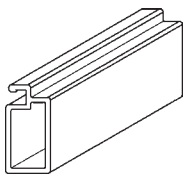

90-1040
(7/16" x 7/8") Plain

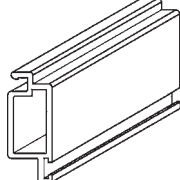

90-1042
(7/16" x 7/8") w/Woolpile

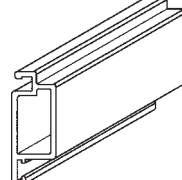

90-1043
(7/16" x 7/8") w/Reverse
Woolpile

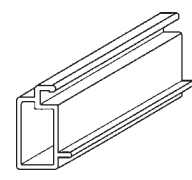

90-1041
(7/16" x 7/8") w/Stopleg

Group 4 - .040 GAUGE

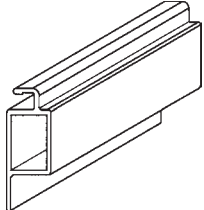

90-1048
(3/8" x 3/4" Box x 5/16" Flange)
For Exterior Application

Group 5 - .045 GAUGE

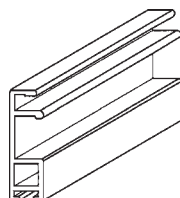

90-1045
(5/16" x 1") Plain

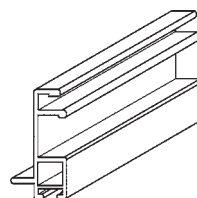

90-1046
(5/16" x 1") w/Stopleg

Group 6 - Crossbar

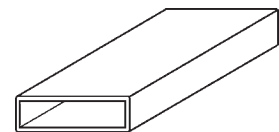

90-1044
(5/16" x 1")

Need Lineals? - Call Today for Lineal Carton Quantities and Pricing

Extruded Window Screen Hardware

PLUNGER ASSEMBLIES

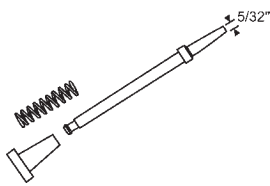

Part #	Cap Color
90-532	White
90-532B	Black

5/32" Blunt Tip. Metal Plunger

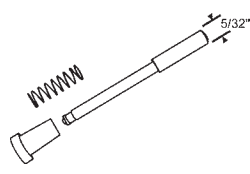

Part #	Cap Color
90-513	White
90-513B	Black

5/32" Metal Plunger.
1-21/32" Long



900-22575
5/32" Special Sharp
Metal Plunger

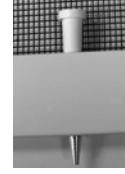

Part #	Cap Color
90-1061	White
90-1061B	Black

5/32" Special Sharp Metal
Plunger. Longer Reach

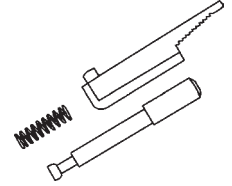

Part #	Cap Color
90-635FT	White
90-635BFT	Black

5/32" Flip Type. Metal Plunger

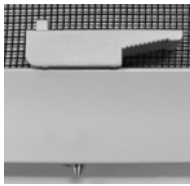

Part #	Cap Color
90-1059	White
90-1059B	Black

5/32" Flip Type, Tapered Point
Metal Plunger



Part #	Cap Color
90-1060	White
90-1060B	Black

5/32" Tapered Point
Metal Plunger



Part #	Cap Color
90-1062	White
90-1062B	Black

5/32" SNE #2 Metal Plunger

WIRE LOOP LATCH

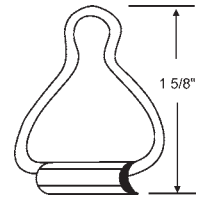

90-103X

PULL TABS

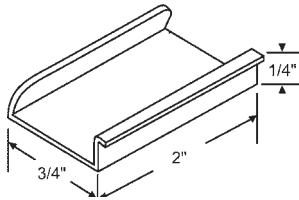

Part #	Finish
90-118	Aluminum
90-118WH	White

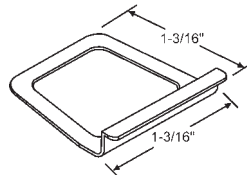

Part #	Finish
900-14950	Natural Nylon
900-14950W	White
900-14950B	Black

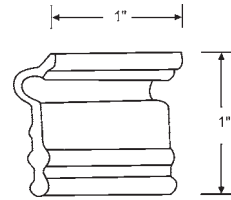

90-633
Black Rubber

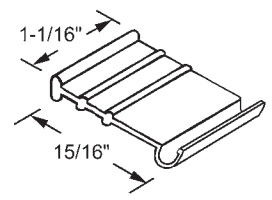

Part #	Finish
90-634	Black
90-634G	Grey

Vinyl

TENSION SPRINGS

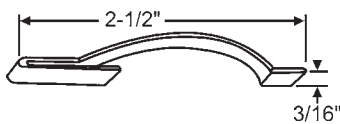

900-17211
Mill

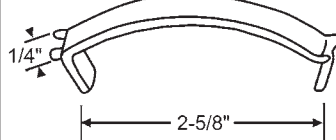

16-158
Stainless Steel

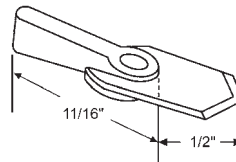

Part #	Finish
900-9823W	White
900-9823	Black

LATCH SET

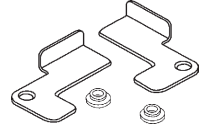

Part #	Hand	Finish
90-385	RH	Mill
90-384	LH	Mill
90-385W	RH	White
90-384W	LH	White

WEATHERSTRIP

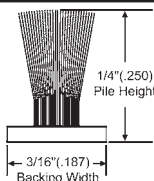

63-507
Grey

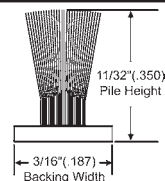

63-508
Grey

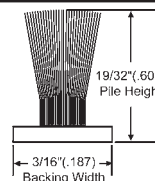

63-509
Grey

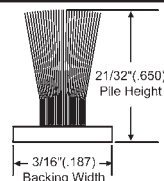

63-510
Grey

Screen Hardware

Screen Frames

Freight pre-paid on 10 or more full cartons of frame. Only applies to 12' 6" length cartons. No freight allowance on 8' length cartons.

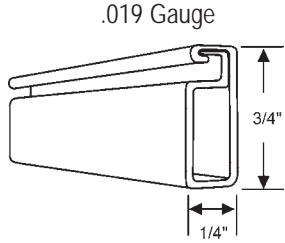

Part #	Length	Carton Qty	Wt	Color
90M-250	12' 6"	184 lgths	135 lbs.	Mill
90M-250AD	12' 6"	184 lgths	135 lbs.	Almond
90M-251	12' 6"	184 lgths	135 lbs.	White
90M-252	12' 6"	184 lgths	135 lbs.	Bronze
90M-253	8'	20 lgths	12 lbs.	Mill
90M-254	8'	20 lgths	12 lbs.	White
90M-255	8'	20 lgths	12 lbs.	Bronze

Screen frame uses .140-9/64" Spline.

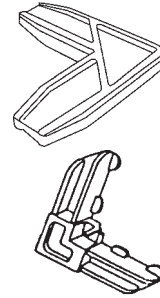

90M-352
Inside Corner Key
Plastic

Part #	Color
90-451	Mill
90-451AD	Almond
90-452	White
90-453	Dark Bronze

Outside Corner Key
Plastic

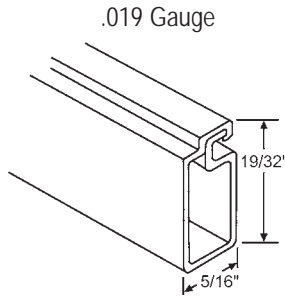

Part #	Length	Carton Qty	Wt	Color
90-232	12' 6"	190 lgths	100 lbs.	Mill
90-233	12' 6"	190 lgths	100 lbs.	White

Screen frame uses .140-9/64" spline.

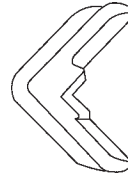

90-346
Inside Corner Key.
Metal

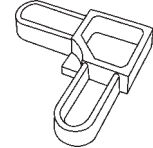

Part #	Color
900-21783W	White
900-21783GY	Grey

Outside Corner Key. Plastic
Philips

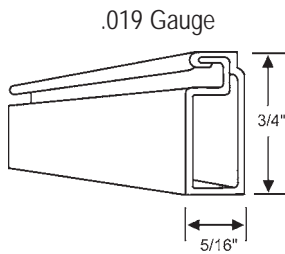

Part #	Length	Carton Qty	Wt	Color
90M-220	12' 6"	152 lgths	105 lbs.	Mill
90M-220AD	12' 6"	152 lgths	105 lbs.	Almond
90M-221	12' 6"	152 lgths	105 lbs.	White
90M-222	12' 6"	152 lgths	105 lbs.	Bronze
90M-223	8'	20 lgths	12 lbs.	Mill
90M-224	8'	20 lgths	12 lbs.	White
90M-225	8'	20 lgths	12 lbs.	Bronze

Screen frame uses .140-9/64" spline.

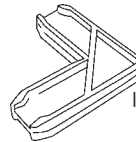

90M-106
Inside Corner Key
Plastic

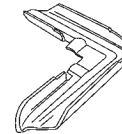

90M-106M
Inside Corner Key
Metal

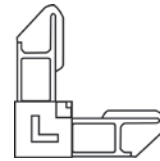

Part #	Color
90M-560	Gray
90M-560AD	Almond
90M-560BZ	Bronze
90M-560W	White

Outside Corner Key with Stop Leg
Plastic

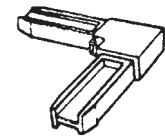

Part #	Color
90M-436	Mill
90M-436AD	Almond
90M-437	White
90M-438	Bronze

Outside Corner Key
Plastic

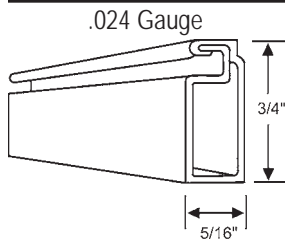

Part #	Length	Carton Qty	Wt	Color
90M-229	8'	20 lgths	12 lbs.	Mill
90M-230	8'	20 lgths	12 lbs.	White
90M-231	8'	20 lgths	12 lbs.	Bronze

Screen frame uses .140-9/64" spline.

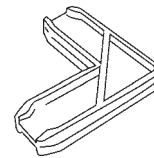

90M-106
Inside Corner Key. Plastic

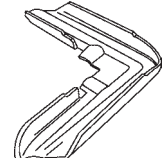

90M-106M
Inside Corner Key. Aluminum

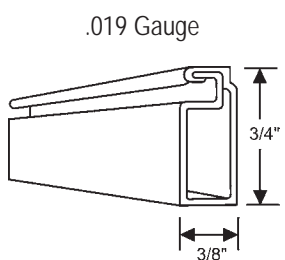

Part #	Length	Carton Qty	Wt	Color
90M-196	12' 6"	128 lgths	90 lbs.	Mill
90M-196AD	12' 6"	128 lgths	90 lbs.	Almond
90M-197	12' 6"	128 lgths	90 lbs.	White
90M-198	12' 6"	128 lgths	90 lbs.	Bronze
90M-199	8'	20 lgths	12 lbs.	Mill
90M-200	8'	20 lgths	12 lbs.	White
90M-201	8'	20 lgths	12 lbs.	Bronze

Screen frame uses .140-9/64" spline.

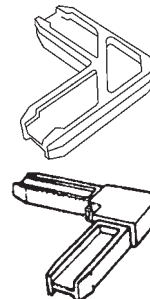

90M-125
Inside Corner Key
Plastic

Part #	Color
90M-454	Mill
90M-454AD	Almond
90M-455	White
90M-456	Bronze

Outside Corner Key. Plastic

Screen Frames

Freight pre-paid on 10 or more full cartons of frame. Only applies to 12' 6" length cartons. No freight allowance on 8' length cartons.

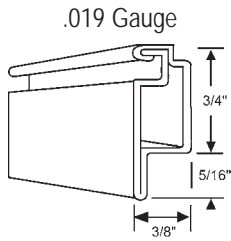

Part #	Length	Carton Qty	Wt	Color
90M-256	12' 6"	105 lgths	95 lbs.	Mill
90M-256AD	12' 6"	105 lgths	95 lbs.	Almond
90M-257	12' 6"	105 lgths	95 lbs.	White
90M-258	12' 6"	105 lgths	95 lbs.	Bronze
90M-259	8'	20 lgths	12 lbs.	Mill
90M-260	8'	20 lgths	12 lbs.	White
90M-261	8'	20 lgths	12 lbs.	Bronze

Screen frame uses .140-9/64" spline.

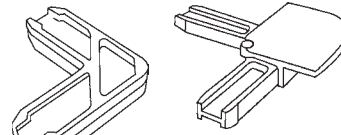

90M-125
Inside Corner Key
Plastic

Part #	Color
90M-633	Mill
90M-633AD	Almond
90M-634	White
90M-635	Bronze

Outside Corner Key
Plastic

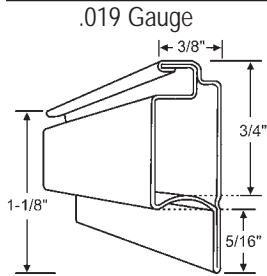

A Good Substitute For Bayform Series B38LI Frame

Part #	Length	Carton Qty	Wt	Color
90M-314	12' 6"	105 lgths	95 lbs.	White
90M-646	8'	20 lgths	30 lbs.	White

Screen frame uses .140-9/64" spline.

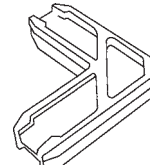

90M-125
Inside Corner Key
Plastic

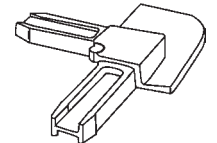

90M-648
Outside Extruded Corner
Key, White Plastic.

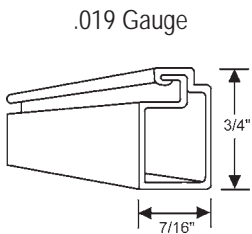

Part #	Length	Carton Qty	Wt	Color
90M-280	12' 6"	112 lgths	85 lbs.	Mill
90M-280AD	12' 6"	112 lgths	85 lbs.	Almond
90M-281	12' 6"	112 lgths	85 lbs.	White
90M-282	12' 6"	112 lgths	85 lbs.	Bronze
90M-283	8'	20 lgths	12 lbs.	Mill
90M-284	8'	20 lgths	12 lbs.	White
90M-285	8'	20 lgths	12 lbs.	Bronze

Screen frame uses .140-9/64" spline.

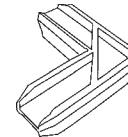

90M-463
Inside Corner Key, Plastic

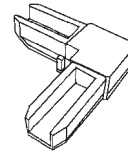

Part #	Color
90M-460	Mill
90M-460AD	Almond
90M-461	White
90M-462	Bronze

Outside Corner Key, Plastic

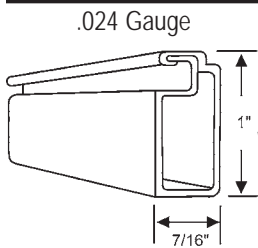

A Good Substitute to Fit Andersen Windows

When substituting for an Andersen screen, use the external plastic corner keys.

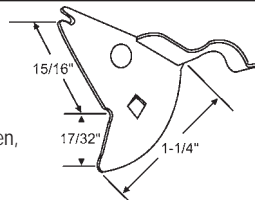

90-515
Butterfly Latch

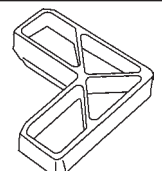

90-503P
Internal Plastic Corner

Part #	Length	Carton Qty	Wt	Color
90-504M	12' 6"	84 lgths	100 lbs.	Mill
90-504W	12' 6"	84 lgths	100 lbs.	White
90-504AD	12' 6"	84 lgths	100 lbs.	Almond
90-504BG	12' 6"	84 lgths	100 lbs.	Beige
90-504S	12' 6"	84 lgths	100 lbs.	Stone
90-504BZ	12' 6"	84 lgths	100 lbs.	Bronze
90-505M	8'	14 lgths	9 lbs.	Mill
90-505W	8'	14 lgths	9 lbs.	White
90-505BZ	8'	14 lgths	9 lbs.	Bronze

Screen frame uses .140-9/64" spline.

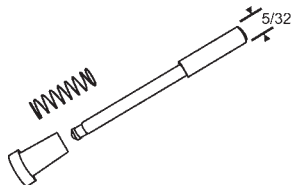

Part #	Cap Color
90-513	White Cap
90-513B	Black Cap

Plunger Pin, 5/32" Diameter Tip

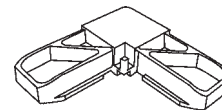

Part #	Color
90M-464	White
90M-464AD	Almond
90M-465	Dark Bronze

External Square Plastic Corner Key

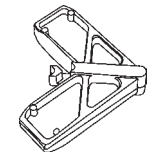

Part #	Color
90-503BZ	Bronze
90-503AD	Almond
90-503W	White
90-503S	Stone

External Plastic Corner Key

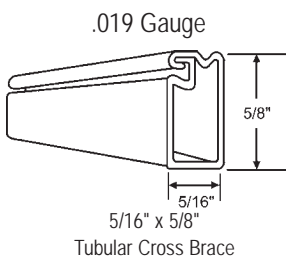

Tubular Cross Brace

Part #	Length	Carton Qty	Wt	Color
90M-184	12' 6"	153 lgths	110 lbs.	Mill
90M-184AD	12' 6"	153 lgths	110 lbs.	Almond
90M-185	12' 6"	153 lgths	110 lbs.	White
90M-186	12' 6"	153 lgths	110 lbs.	Bronze
90M-187	8'	20 lgths	12 lbs.	Mill
90M-188	8'	20 lgths	12 lbs.	White
90M-189	8'	20 lgths	12 lbs.	Bronze

Screen frame uses .140-9/64" spline.

CROSS BRACES

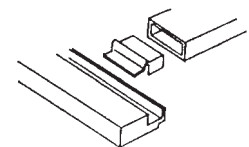

90M-386
Cross Brace Insert
Fits 5/16" x 5/8" Cross Brace

Screen Hardware

Screen Wire & Screen Cloth

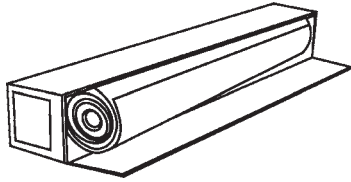

FREE FREIGHT On 25 or more assorted 100' or 600' rolls.

Popular sizes in stock for quick shipment.

Fiberglass 18 x 16 Mesh 100 Foot Roll

Popular package for contractors and for hardware stores that repair screens.

- 011" Diameter
- Easy to Install
- Resilient, Long Lasting
- Fire and Corrosion Resistant
- Will Not Crease, Dent or Unravel
- Withstands All Climates, Salt Air and Industrial Fumes

Width	Charcoal Part #	Gray Part #
16"	69-1	69-2
18"	69-7	69-8
20"	69-13	69-14
22"	69-19	69-20
24"	69-25	69-26
26"	69-31	69-32
28"	69-37	69-38
30"	69-43	69-44
32"	69-49	69-50
34"	69-55	69-56
36"	69-61	69-62
42"	69-67	69-68
48"	69-73	69-74
60"	69-79	69-80
72"	69-85	69-86

Aluminum 18 x 16 Mesh 100 Foot Roll

Popular package for contractors and for hardware stores that repair screens.

- 011" Diameter
- Strong and Durable
- Resists Rust, Won't Sag
- Withstands all Climates
- Protective Finish Prevents Corrosion, Strengthens Weave, Enhances Appearance

Width	Bright Part #	Charcoal Part #	Black Part #
16"	69-5	69-6	69-6B
18"	69-11	69-12	69-12B
20"	69-17	69-18	69-18B
22"	69-23	69-24	69-24B
24"	69-29	69-30	69-30B
26"	69-35	69-36	69-36B
28"	69-41	69-42	69-42B
30"	69-47	69-48	69-48B
32"	69-53	69-54	69-54B
34"	69-59	69-60	69-60B
36"	69-65	69-66	69-66B
42"	69-71	69-72	69-72B
48"	69-77	69-78	69-78B
60"	69-83	69-84	69-84B
72"	69-89	69-90	69-90B

Fiberglass 7' Roll

Popular item for home centers and hardware stores. A big do-it-yourself item. Enough to cover two average size windows or one screen door.

Width	Charcoal Part #
30"	69-43-7
36"	69-61-7
48"	69-73-7

Fiberglass 18 x 16 Mesh 600 Foot Roll (Other Sizes Available)

Width	Charcoal Part #	Gray Part #
24"	69-27	69-28
36"	69-63	69-64
48"	69-75	69-76



Premium fiberglass invisible screen cloth

(20 x 20 mesh .008" diameter)

Invisible Screen, our new fiberglass mesh product offering 50% more visibility than standard fiberglass screening at a fraction of the cost of competitive products. Available in our most popular color, charcoal, this lightweight screen offers the same ease of installation and weathering benefits as standard fiberglass screening.

Size	Charcoal Part #
24" x 100'	69-125
30" x 100'	69-143
36" x 100'	69-161
48" x 100'	69-173



Solar Screen Cloth

(54 x 18 mesh .011" diameter)

Solar Screening is an inexpensive and easy to install alternative designed to provide an attractive outdoor appearance while maintaining good visibility from inside with no distortion. It filters sunlight, helps reduce air conditioning bills and lessens fading of carpet, upholstery and drapes. Superior heat resistance and color retention help keep it looking great for years.

Size	Charcoal Part #
24" x 100'	69-S25
30" x 100'	69-S43
36" x 100'	69-S61
48" x 100'	69-S73
60" x 100'	69-S79
72" x 100'	69-S85

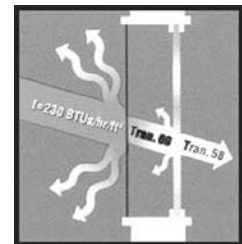

Energy-saving sun screening provides maximum solar control and visibility. Reflects and dissipates up to 75% of sun's rays entering the building.

Screen Wire & Screen Cloth



Charcoal

Pool, Porch & Patio Fiberglass Screen Cloth

(18 x 14 Mesh .013" Diameter)

Pool, Porch & Patio Screening is for use in pool, patio and sun room enclosures. It offers superior strength and durability.

Width	Charcoal Part #
36" x 100'	69-P61
48" x 100'	69-P73
60" x 100'	69-P79
72" x 100'	69-P85
84" x 100'	69-P92
96" x 100'	69-P96
108" x 100'	69-P108



Ultra strong screening resists tears and damage by dogs and cats yet still offers superb outward visibility. Ideal for areas where children or pets push against the screen.

Resistant to tears and damage caused by household pets.

Pet Screen Cloth

(17 x 11 Mesh .025" Diameter)

Width	Charcoal Part #
36" x 100'	69-PP61
36" x 7'	69-PP61-7
48" x 100'	69-PP73
48" x 7'	69-PP73-7



Charcoal

No-See-Um Fiberglass Screen Cloth

(20 x 20 Mesh .013" Diameter)

Finer mesh screening to protect against no-see-ums, gnats, sand flies, and other tiny, irritating insects common in low marshy areas.

Width	Charcoal Part #
36" x 100'	69-61NSM
48" x 100'	69-73NSM
60" x 100'	69-79NSM



Bronze

Bronze Screening

(18 x 14 Mesh .011" Diameter)

Our heavy-duty solid bronze insect screening is designed for fabrication of high quality window screens and screen doors. It is woven of .011" solid bronze wire into an 18 X 14 mesh.

Width	Bright Bronze Part #
24" x 100'	69-29BR
30" x 100'	69-47BR
36" x 100'	69-65BR
48" x 100'	69-77BR

Screen Spline

Gray & Black Vinyl Hollow Ribbed Spline

Replacement spline for metal and fiberglass screening available in 100 ft., 250 ft., 500 ft. and 1,000 ft. spools.

100 Foot Spools

Part # Gray	Part # Black	Trade Size	Decimal Size
66-1	66-1B	1/8"	.120
66-5	66-5B	9/64"	.140
66-9	66-9B	11/64"	.165
66-13	66-13B	3/16"	.187
66-17	66-17B	15/64"	.230
66-21	66-21B	1/4"	.250



Sold by Spools

250 Foot Spools

Part # Gray	Part # Black	Trade Size	Decimal Size
66-2	66-2B	1/8"	.120
66-6	66-6B	9/64"	.140
66-10	66-10B	11/64"	.165
66-14	66-14B	3/16"	.187
66-18	66-18B	15/64"	.230
66-22	66-22B	1/4"	.250



1/8" (.120)



9/64" (.140)



11/64" (.165)



3/16" (.187)



15/64" (.230)



1/4" (.250)

Screen Hardware

Screen Spline

Gray & Black Vinyl Hollow Ribbed Spline (Continued)

500 Foot Spools

Part # Gray	Part # Black	Trade Size	Decimal Size
66-3	66-3B	1/8"	.120
66-7	66-7B	9/64"	.140
66-11	66-11B	11/64"	.165
66-15	66-15B	3/16"	.187
66-19	66-19B	15/64"	.230
66-23	66-23B	1/4"	.250

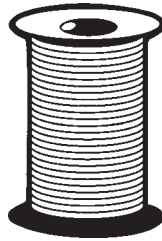

Sold by Spools

1000 Foot Spools

Part # Gray	Part # Black	Trade Size	Decimal Size
66-4	66-4B	1/8"	.120
66-8	66-8B	9/64"	.140
66-12	66-12B	11/64"	.165
66-16	66-16B	3/16"	.187
66-20	66-20B	15/64"	.230



1/8" (.120)



9/64" (.140)



11/64" (.165)



3/16" (.187)



15/64" (.230)



1/4" (.250)

Gray & Black Vinyl Hollow Round Spline

Replacement spline for metal and fiberglass screening. Available in 200 ft., 750 ft., and 1,000 ft. spools.

200 Foot Spools

Part # Gray	Part # Black	Trade Size	Decimal Size
66-64	66-65	1/8"	.125
66-68	66-69	9/64"	.140
66-72	66-73	5/32"	.156
-	66-77	11/64"	.172
66-80	66-81	13/64"	.203
66-84	66-85	15/64"	.234

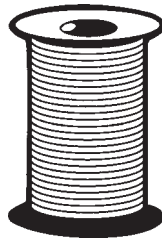

Sold by Spools

1000 Foot Spools

Part # Gray	Part # Black	Trade Size	Decimal Size
66-62	66-63	1/8"	.125
66-66	66-67	9/64"	.140
66-70	66-71	5/32"	.156
-	66-75	11/64"	.172
-	66-79	13/64"	.203
66-82	66-83	15/64"	.234

750 Foot Spools

Part # Black	Trade Size	Decimal Size
66-87	1/4"	.250



1/8" (.125)



9/64" (.140)

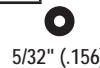

5/32" (.156)



11/64" (.172)



13/64" (.203)



15/64" (.234)



1/4" (.250)

Solid Black Foam Spline

Replacement spline for metal and fiberglass screening. Available in 500 ft., 1,000 ft., 1,500 ft. and 3,000 ft. spools.

500 Foot Spools

Part # Black	Decimal Size
66-40	.135
66-42	.140
66-44	.150
66-46	.155
66-48	.170
66-50	.235
66-52	.250

1000 Foot Spools

Part # Black	Decimal Size
66-41	.135
66-43	.140
66-45	.150
66-47	.155
66-49	.170
66-51	.235
66-53	.250
66-60M	.270

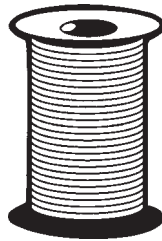

Sold by Spools

- Solid Black Foam Spline produced with only 100% virgin materials.
- User friendly - helps reduce operator fatigue.
- The softness of solid black foam spline allows it to be easily inserted in channels and allows easy cornering.
- Helps reduce customers' inventory. One size will work for several different screen channels.

1500 Foot Spools

Part # Black	Decimal Size
66-57	.235
66-34	.250

3000 Foot Spools

Part # Black	Decimal Size
66-54	.135
66-30	.140
66-55	.150
66-56	.155
66-31*	.170

(* 2700 Foot spools only)



.135



.140



.150



.155



.170



.235



.250



.270

Screen Door Spline

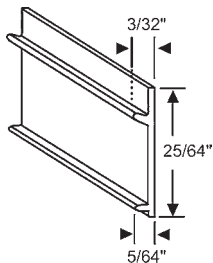

66-61X

Vinyl Screen Spline. Black
Sold in 100' Rolls
Forever Door

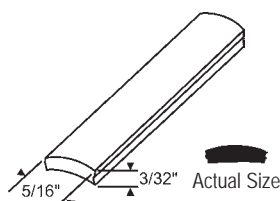

Part #	Length
16-240B	100 ft. Roll
16-240BM	1000 ft. Roll

Flat Spline. Black

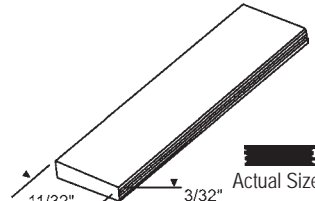

Part #	Length
16-239	100 ft. Roll
16-239X	750 ft. Roll

Flat Spline. Black
Peachtree

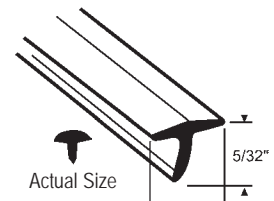

Part #	Length
16-241	100 ft. Roll
16-241M	1000 ft. Roll

Black Spline made of polyethylene. Used with fiberglass cloth for patio screen doors.

Retractable Window Screen Systems

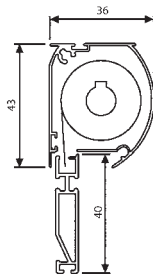

36mm Cassette

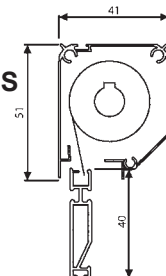

41mm Cassette

VERTICAL RETRACTABLE WINDOW SYSTEMS

Genius vertical window screen systems add a distinctive touch to any window. This unique design is small enough to rest virtually unnoticed in the reveal of a window. Customize in your shop or in the field for a fast and easy installation. Because the screen is protected when not in use, there is never a need to remove and store screens during the winter.



36MM SYSTEM			41MM SYSTEM		
Part #	Color	Maximum Opening	Part #	Color	Maximum Opening
990-300W	White	24" x 52"	990-304W	White	24" x 66"
990-300BRN	Brownstone	24" x 52"	990-304BRN	Brownstone	24" x 66"
990-301W	White	36" x 52"	990-305W	White	36" x 66"
990-301BRN	Brownstone	36" x 52"	990-305BRN	Brownstone	36" x 66"
990-302W	White	48" x 52"	990-306W	White	48" x 66"
990-302BRN	Brownstone	48" x 52"	990-306BRN	Brownstone	48" x 66"
990-303W	White	60" x 52"	990-307W	White	60" x 66"
990-303BRN	Brownstone	60" x 52"	990-307BRN	Brownstone	60" x 66"

HORIZONTAL RETRACTABLE WINDOW SYSTEMS

Genius horizontal window screen systems add a distinctive touch to any window. This unique design is small enough to rest virtually unnoticed in the reveal of a window. Customize in your shop or in the field for a fast and easy installation. Because the screen is protected when not in use, there is never a need to remove and store screens during the winter.



36MM SYSTEM			41MM SYSTEM		
Part #	Color	Maximum Opening	Part #	Color	Maximum Opening
990-400W	White	36" x 36"	990-403W	White	66" x 36"
990-400BRN	Brownstone	36" x 36"	990-403BRN	Brownstone	66" x 36"
990-401W	White	52" x 48"	990-404W	White	66" x 48"
990-401BRN	Brownstone	52" x 48"	990-404BRN	Brownstone	66" x 48"
990-402W	White	52" x 60"	990-405W	White	66" x 60"
990-402BRN	Brownstone	52" x 60"	990-405BRN	Brownstone	66" x 60"

SALESMEN' SAMPLES/ACCESSORIES



SALESMEN' HAND DISPLAY SAMPLES		
Part #	Size	Description
990-19V	36mm	Vertical Window Sample
990-41V	41mm	Vertical Window Sample



SALESMEN PROMOTIONAL ACCESSORIES		
Part #	Quantity	Description
500-217	100/Bundle	Genius Consumer Brochures
500-218	100/Bundle	Genius Promotional Hanger
500-219	—	Color Options Sheet
500-220	—	Genius DVD

Other colors also available through special order: Silver, Almond, Adobe Gray, Hunter Green and Desert Tan.

Charcoal fiberglass screening is included as standard. Call for other options.

Screen Hardware

Tension Springs

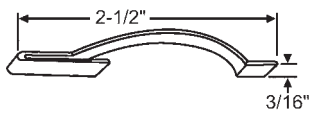

900-17211

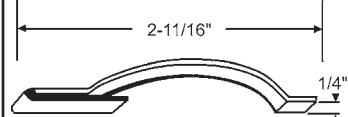

90-498

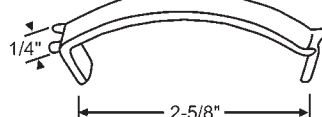

16-158

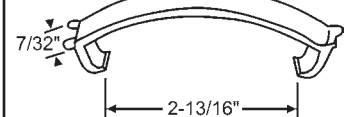

900-17011

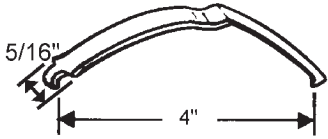

90-98



900-12221
Ram Horn Spring

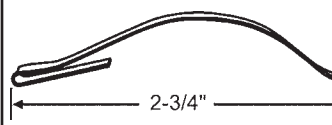

900-18037

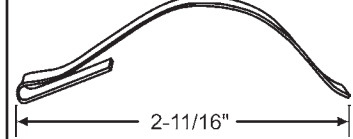

90-628
Tension Spring 1/4" Wide

Wire Loop Latches

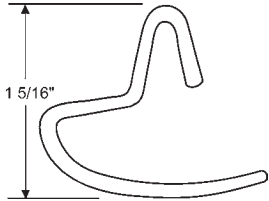

90-127

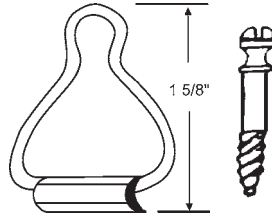

90-103
Wire Loop Latch Set
90-103X Loop Only
20-019 Screw Only

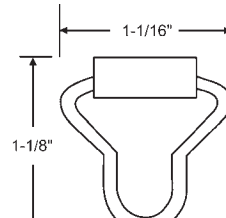

90-104
Small Loop Latch. Used with Ball Head
Screw 20-019

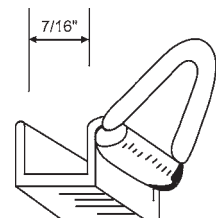

900-9851
Slip-On Type
Aluminum Finish

Aluminum Stretch Clips

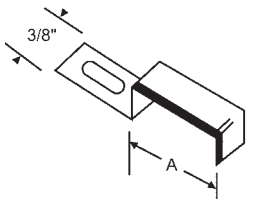

Part #	"A"	"B"	Part #	"A"	"B"
90-60	5/8"	1/4"	90-58	3/4"	5/16"
90-68	5/8"	5/16"	90-58BZ	3/4"	5/16"
90-65	11/16"	1/4"	90-58W	3/4"	5/16"
90-72	11/16"	9/32"	90-59	3/4"	3/8"
90-61	11/16"	3/8"	90-62	13/16"	9/32"
90-71	3/4"	9/32"	90-55	7/8"	5/16"

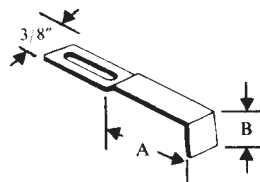

Part #	"A"	"B"
90-67	11/16"	11/32"
90-57	7/8"	11/32"
90-64	7/8"	5/16"

Cee Clips

Zee Clips

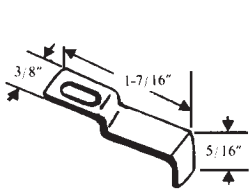

90-69

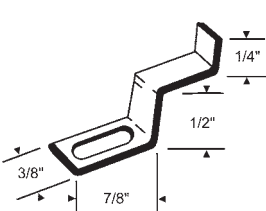

90-66

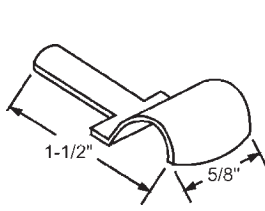

90-850
Old Miami

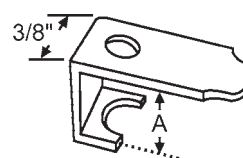

Part #	"A"
90-30	3/16"
90-31	1/4"
90-32	3/8"
90-33	7/16"
90-34	5/16"

Aluminum

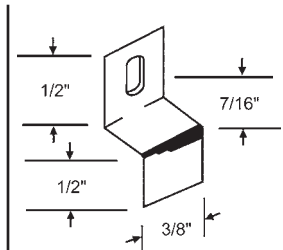

Part #	Description
90-52	Stainless Steel

Screen Hardware

Retainer Clip

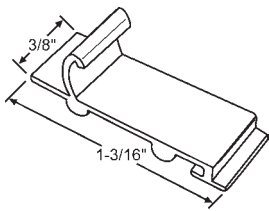

90-839
White Nylon
Screen Spring Retainer Clip
Patriot

Pivot Post

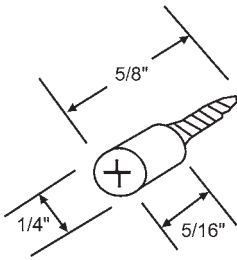

900-9351
Acorn

Butterfly Lock

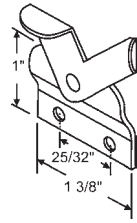

Part #	Hand
90-488LH	Shown
90-488RH	Opposite

1/8" Offset

Hanger

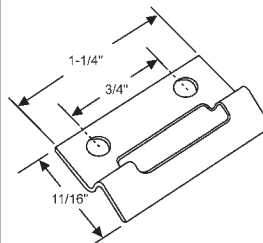

900-7098
Female Hanger
Jim Walters

Pointer Latch

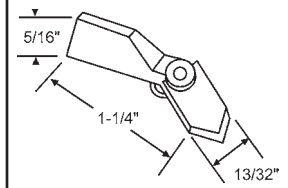

Part #	Color
90-124	White
90-124B	Black

Latches

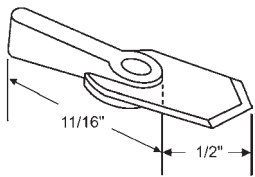

Part #	Color
900-9823	Black
900-9823W	White
900-9823N	Natural

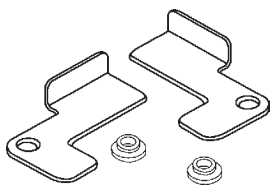

90-384A
Screen Latch Set
LH Only: 90-384. RH Only: 90-385
Bushing Only: 900-7231

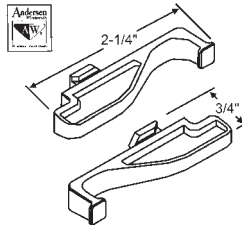

Part #	Color
750-0873293	Stone
750-0873292	White

Screen Latch Set

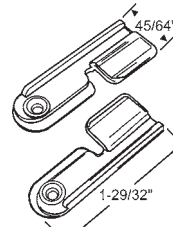

900-21432
Clear Plastic
Peachtree

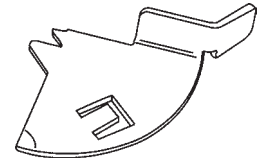

Part #	Hand
90-383	Shown
90-382	Opposite

Knife Latch. Mill

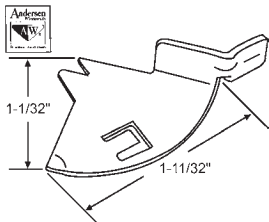

750-2962208
Pair

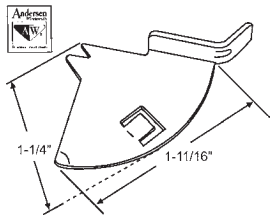

750-2962214
Pair

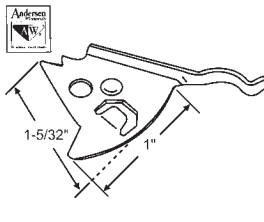

750-2962218
Pair

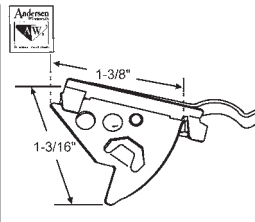

750-2962202
Pair. Stone Finish

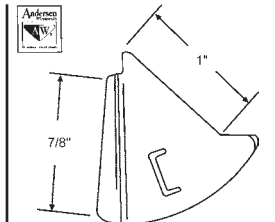

750-2962216
Pair

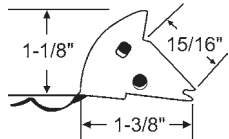

90-506
Pair

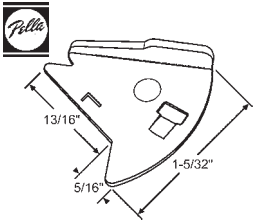

90-883A
Sold in Sets Only (LH Shown)

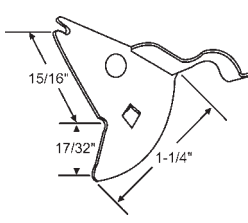

90-515
Pair (LH/RH)
Stainless Steel

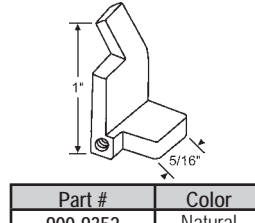

Part #	Color
900-9352	Natural
900-9352B	Black

Nylon Screen Latch without Screw.
For Screw order #20-520
Acorn

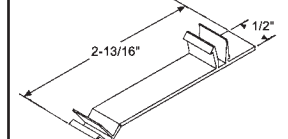

900-18585
Vinyl Screen Latch
Malta

Slide Latches

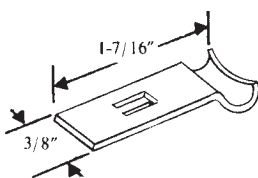

90-90
Aluminum

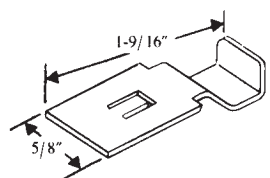

90-91
Aluminum

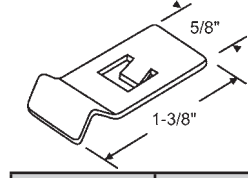

Part #	Color
90-715	Bronze
90-715W	White
90-715M	Mill

Fixed Pins

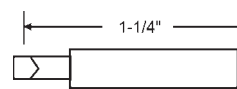

90-698
5/32"x1-1/4"
Aluminum

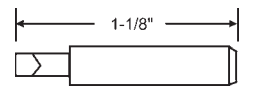

Part #	Description
900-21792	5/32" Plunger
900-21747	7/32" Plunger

Cross Brace Insert

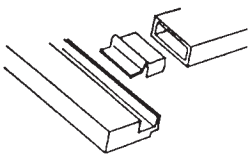

90-313

Fits 1/4" x 3/4" Cross Brace

Screen Corners

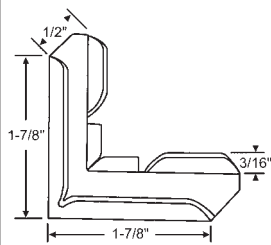

Part #	Color
90-125	Mill
90-125B	Black

Metal

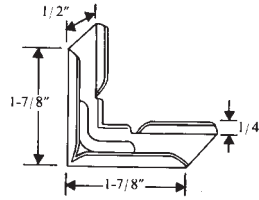

90-106

Metal

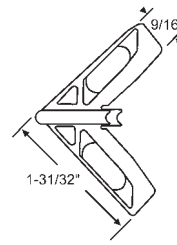

Part #	Color
90-865TN	Tan
90-865	White
90-865BZ	Bronze

Plastic

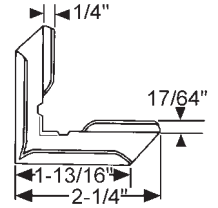

90-487

Metal

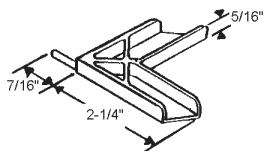

90-13515

Black
Acorn

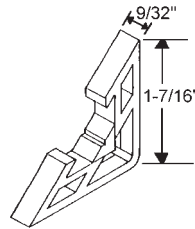

900-10679B

Black
Seasonall

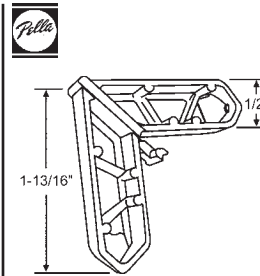

900-16634

Champagne

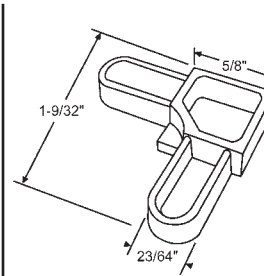

Part #	Color
900-21783W	White
900-21783GY	Gray

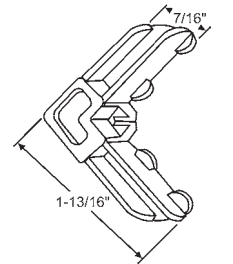

Part #	Color
90-347	Gray
90-348	White
90-349	Dark Bronze

Plastic

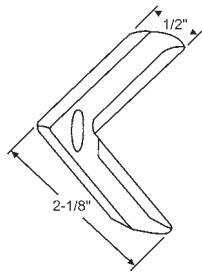

90-352

Metal

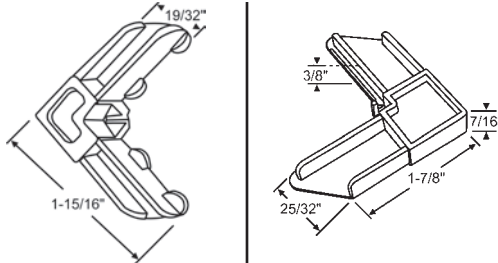

Part #	Color
90-436	Gray
90-437	White
90-438	Dark Bronze

Plastic

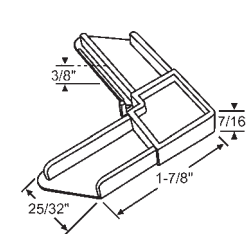

Part #	Color
900-19936	Beige
900-19936WH	White

Plastic. Fits Kolbe

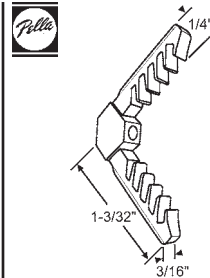

90-931W

White

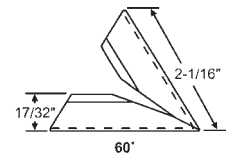

90-978

60° Aluminum Corner for 3/8" x 3/4" Screen Frame
Bayform

Grille Fastener

Lifts & Pull Tabs

Lifts Packaged 25 Per Bag

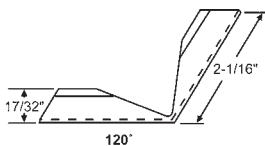

90-979

120° Aluminum Corner for 3/8" x 3/4" Screen Frame

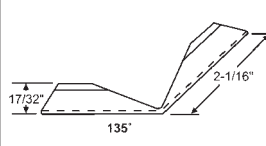

90-980

135° Aluminum Corner for 3/8" x 3/4" Screen Frame
Bayform

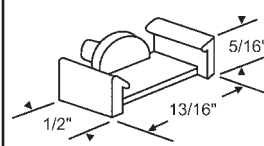

900-1451C

Clear

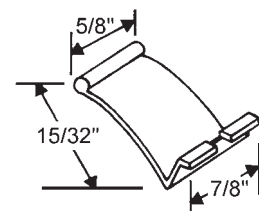

Part #	Color
90-116	Natural
90-116B	Black

Vinyl

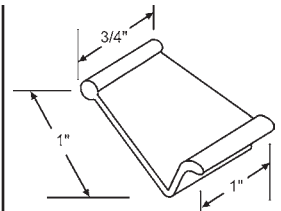

Part #	Color
90-117	Natural
90-117B	Black

Nylon

Screen Hardware

Lifts & Pull Tabs

Lifts Packaged 25 Per Bag

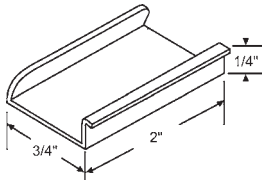

Part #	Color
90-118	Mill
90-118WH	White
90-118BZ	Bronze

Aluminum

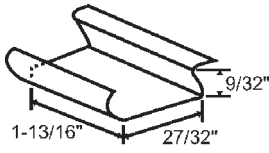

Part #	Color
90-378	Mill

Aluminum

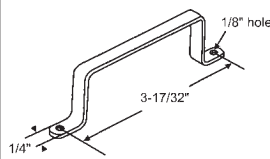

90-390

Flat Aluminum Handle, Mill

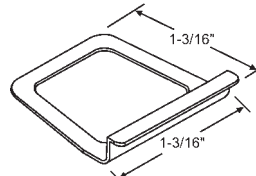

Part #	Color
900-14950	Natural
900-14950B	Black
900-14950W	White

Nylon

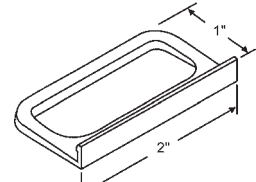

Part #	Color
900-12883	Natural
900-12883B	Black

Nylon

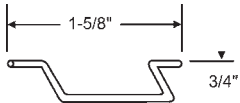

90-377

Wire Lift



750-1631110

Screen Finger Pull

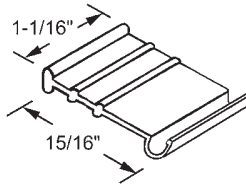

Part #	Color
90-633	Black Flexible
90-634	Black Rigid
90-634G	Gray Rigid

Vinyl

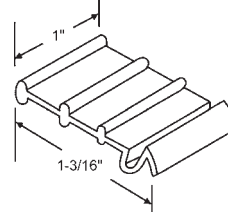

90-129

Plastic, Black

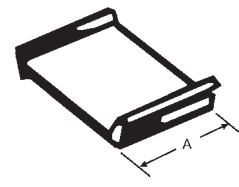

Part #	Color	"A"
90-785	White	3/4"
90-376	Black	1"
90-376GY	Gray	1"

Vinyl

Spring Plungers

In Order by Tip Outside Diameter

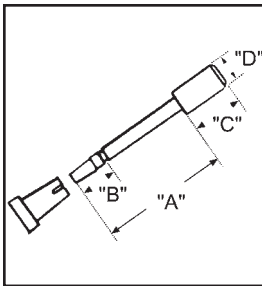

90-15

Snap-On Plastic Knob, White

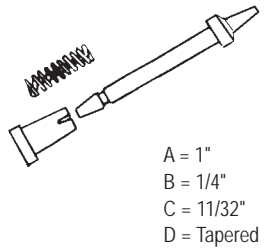

Part #	Knob
90-532	White
90-532B	Black

Blunt Tip Plunger Assembly
Plastic Knob, Black

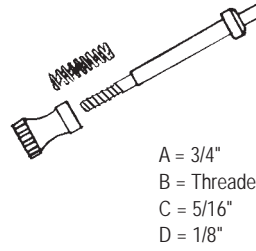

90-22

Metal Screw-On Knob

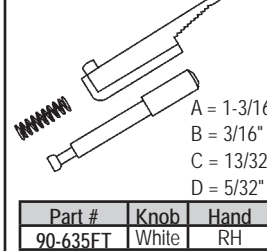

Part #	Knob	Hand
90-635FT	White	RH
90-635FTL	White	LH

Flip Type

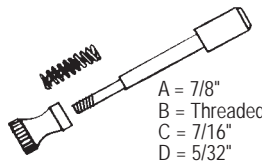

90-21

Screw-On Metal Knob
Metal Plunger

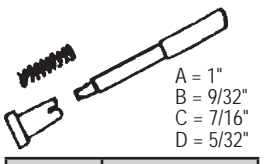

Part #	Knob
90-136	White
90-136B	Black

Snap-On Plastic Knob,
Metal Plunger

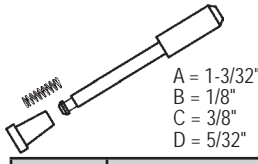

Part #	Knob
90-635	White
90-635B	Black

Metal Plunger

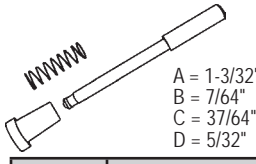

Part #	Knob
90-513	White
90-513B	Black

For Use with 1" Frame

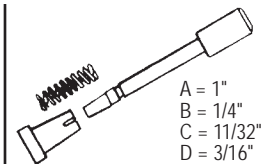

90-23

Snap-On Knob, White Plastic
Metal Plunger

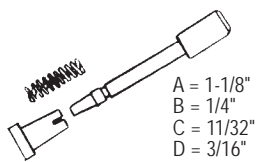

90-20

Snap-On Knob, White Plastic
Metal Plunger

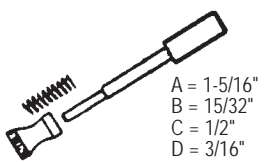

900-7070

Stake-On Knob
Metal Knob and Plunger

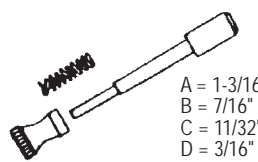

90-322

Stake-On Knob
Metal Knob and Plunger

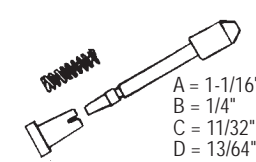

90-12

Snap-On Knob, White
Plastic

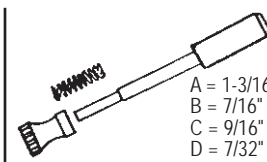

90-327

Stake-On Knob
Metal Knob and Plunger

Spring Plungers

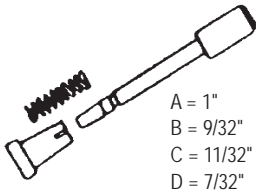

A = 1"
B = 9/32"
C = 11/32"
D = 7/32"

90-312

Snap-On Knob, White Plastic Metal Plunger

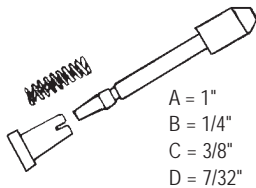

A = 1"
B = 1/4"
C = 3/8"
D = 7/32"

90-14

Snap-On Plastic Knob, White

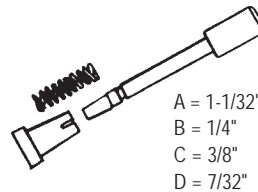

A = 1-1/32"
B = 1/4"
C = 3/8"
D = 7/32"

90-11

Snap-On Plastic Knob, Black

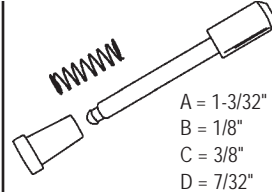

A = 1-3/32"
B = 1/8"
C = 3/8"
D = 7/32"

Part #	Knob
900-9850	White
900-9850B	Black

Snap-On Plastic Knob, Metal Plunger

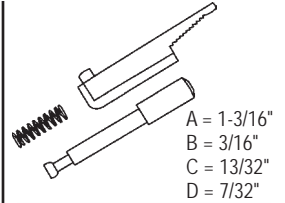

A = 1-3/16"
B = 3/16"
C = 13/32"
D = 7/32"

Part #	Knob	Hand
900-9850FT	White	RH
900-9850FTL	White	LH

Flip Type

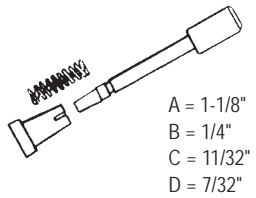

A = 1-1/8"
B = 1/4"
C = 11/32"
D = 7/32"

Part #	Knob
90-24	White
90-24B	Black

Snap-On Plastic Knob, Metal Plunger

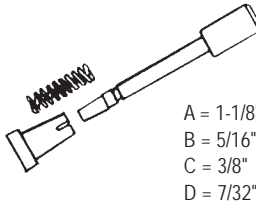

A = 1-1/8"
B = 5/16"
C = 3/8"
D = 7/32"

90-13

Snap-On Plastic Knob, White

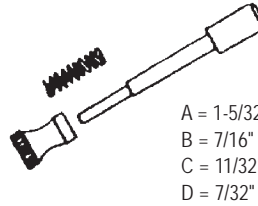

A = 1-5/32"
B = 7/16"
C = 11/32"
D = 7/32"

90-375

Stake-On Metal Knob Metal Plunger

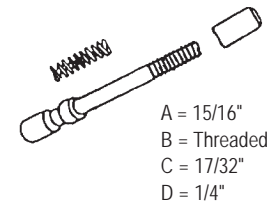

A = 15/16"
B = Threaded
C = 17/32"
D = 1/4"

90-371

Metal Screw-On Knob Metal Plunger

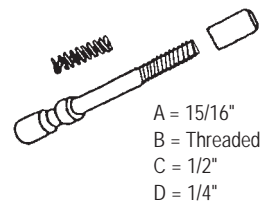

A = 15/16"
B = Threaded
C = 1/2"
D = 1/4"

90-370

Metal Screw-On Knob Metal Plunger

Friction Hangers

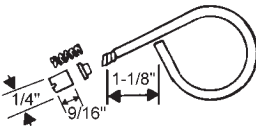

90-514

P-Type Plunger Assembly for 1" Frame

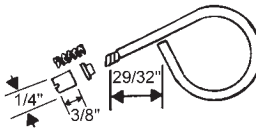

90-25

Tip

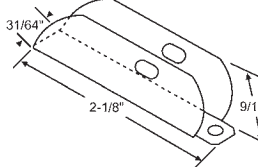

Part #	Frame Thickness	Color
90-120	3/8"	Aluminum
90-389	7/16"	Aluminum
90-389W	7/16"	White
90-389BZ	7/16"	Bronze

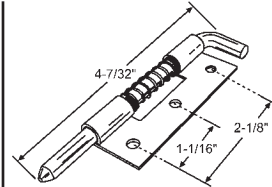

90-736

Low Profile Latch Set Sold in Sets Only.

Warning Label

WARNING!

DO NOT USE SCR FROM WINDOWS. Insect screens are not intended to be persons within the out the window.

500-287

1000 Per Roll 1/2" x 2-3/4"

Pet Screen Door

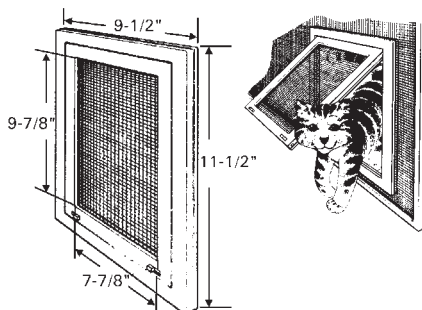

990-2

Pet Screen Bronze

Screen Shield

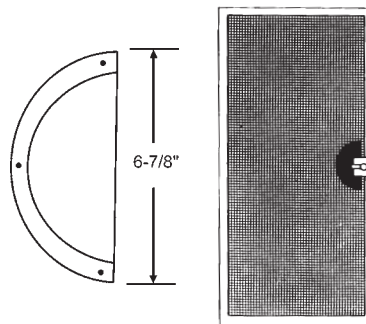

16-191

Screen Shield. Protects Screening Around Door Handle. Snaps Together. Durable Plastic

Automatic Screen Door Closer

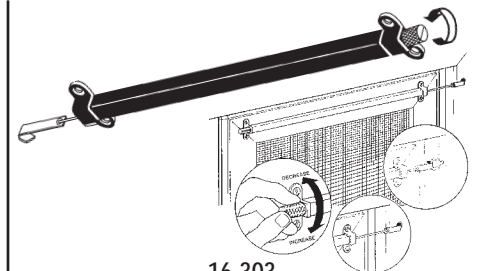

16-303

Screen Door Closer with Screws. Black. Fits Patio Screen Doors 36" and Larger. Simple Installation Takes Only Minutes. Block And Tackle Design Provides Smooth Operation.

Screen Hardware

Custom Made Extruded Aluminum Wicket & Hopper Screens Order Form

Customer Name: _____ Account Number _____

Contact: _____ Phone Number _____

Quantity: _____ Cost: _____ Signature _____ Date _____

For Commercial & Institutional Application

Frame: .050 Gauge, 6063 T5 Aluminum Alloy

1. Select Frame Profile/Color



90-531M

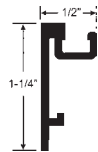

90-509M

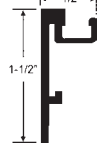

90-497M

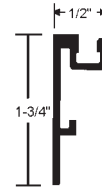

90-530M

- Mill
- Bronze
- White

2. Select Screen Wire

- Bright Aluminum
- Charcoal Aluminum
- Gray Fiberglass
- Charcoal Fiberglass

3. Select Type

- Single Wicket Screen
 - Hinged
 - Sliding
- Hopper Screen
- Double Wicket Screen
 - Hinged
 - Sliding
- Full Height Hinged Wicket Screen
- Other

Wicket Size _____ W x _____ H

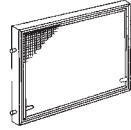
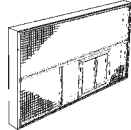

Wicket Size _____ W x _____ H

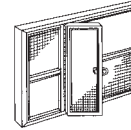
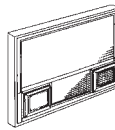

(Specify) _____

4. Screen Size: _____ W x _____ H

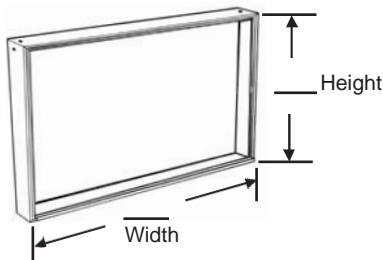

6. Measuring Instructions: For Hardware to be Installed

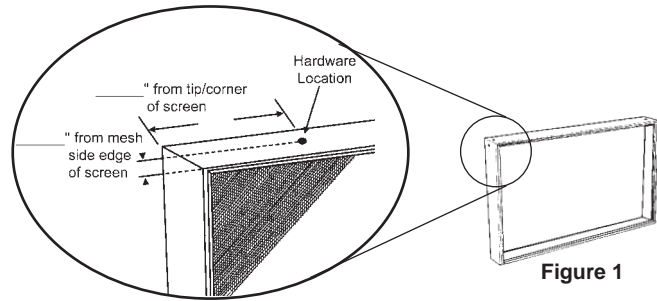

5. Quantity _____

7. Hardware & Hardware Location:

- Hardware to be installed on _____ rail (See Figure 2). Part No. _____
Location: _____ " from tip/corner of screen (See Figure 1)
_____ " in from mesh side edge of screen (See Figure 1)
- Hardware to be installed on _____ rail (See Figure 2). Part No. _____
Location: _____ " from tip/corner of screen (See Figure 1)
_____ " in from mesh side edge of screen (See Figure 1)
- Hardware to be installed on _____ rail (See Figure 2). Part No. _____
Location: _____ " from tip/corner of screen (See Figure 1)
_____ " in from mesh side edge of screen (See Figure 1)
- Hardware to be installed on _____ rail (See Figure 2). Part No. _____
Location: _____ " from tip/corner of screen (See Figure 1)
_____ " in from mesh side edge of screen (See Figure 1)

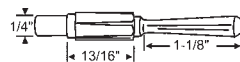

90-100NS

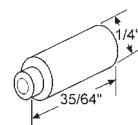

90-551

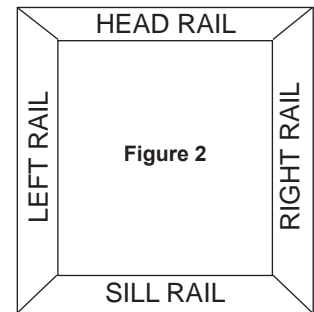

IMPORTANT: Hardware must be located by position. In the spaces above please indicate both height & width AND depth of frame.

Please Call for Pricing and Delivery

Screen Hardware

Screen Door Order Form

CUSTOM MADE PATIO SCREEN DOOR ORDER FORM

Account# _____

Page# ____ of ____

Sold To: _____

Ship To: _____

Purchase Order# _____

Date _____ Quoted By _____

STEP 1 Determine style and material of door

- Custom Roll Form Aluminum
- Custom Roll Form Steel
- Multi-Fit Roll Form Aluminum
- Custom Extruded Aluminum

STEP 2 Determine finish

- Mill (Aluminum Doors)
- Gray (Steel Doors)
- White
- Bronze
- Other _____

STEP 3 Select screen cloth or screen wire

- Charcoal Fiberglass (standard)
- Gray Fiberglass
- Bright Aluminum
- Charcoal Aluminum
- Other _____

STEP 4 Select type of wheel

- Nylon
- Steel
- Stainless Steel

STEP 5 Determine head and sill rail depth

(Note: Deep head/sill only available on assembled Apollo custom aluminum doors)

- 1/16" to 1/4" (standard)
- 5/16" to 5/8"

STEP 9 Select Part Number, Quantity & Size

- 991M-999 ENTERPRISE Custom Roll Form Steel - Assembled
- 997M-999 BOSS Heavy Duty Custom Roll Form Steel - Assembled
- 992M-999 APOLLO Custom Roll Form Aluminum - Assembled
- 995M-999 TITAN Classic Custom Extruded Aluminum - Assembled
- 998M-999 TITAN Contemporary Custom Extruded Aluminum - Assembled
- 996-999 MOOSE Custom Extruded Aluminum - Assembled
- 999M-999 GEMINI Custom Extruded Aluminum - Assembled

STEP 6 Lock Assembly Location:

- Centered (Reversible)
- Inches _____

Measure from the top of the sill track bead up to the center of the existing keeper.

View from the Inside Looking Out: RH LH (check one)

STEP 7 Bug Seal:

- Vinyl Bug Flap - Circle Size: 7/8" 1-1/8" 1-1/2"
- Wool Pile - Circle Size: .250" .350" .380" .450"
- .500" .600" .650" .750"

STEP 8 Measuring Instructions for Custom Screens

Width: Measure from inside the jamb to the center of the first rail of the fixed door.

Height: See Illustration:

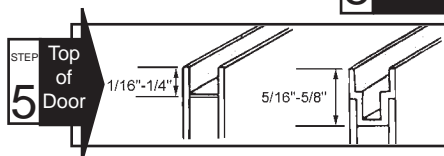
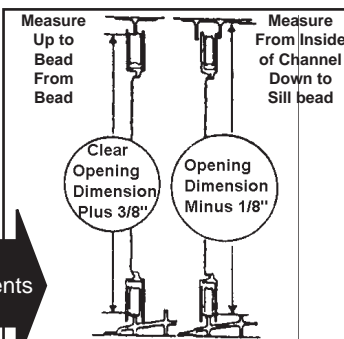

STEP 8 Height Measurements

- 991M-999KD ENTERPRISE Custom Roll Form Steel - Knocked Down
- 997M-999KD BOSS Heavy Duty Custom Roll Form Steel - Knocked Down
- 992M-999KD APOLLO Custom Roll Form Aluminum - Knocked Down
- 995M-999KD TITAN Classic Custom Extruded Aluminum - Knocked Down
- 998M-999KD TITAN Contemporary Custom Extruded Aluminum - Knocked Down
- 996-999KD MOOSE Custom Extruded Aluminum - Knocked Down
- 999M-999KD GEMINI Custom Extruded Aluminum - Knocked Down

•All Knocked Down Doors Come with Cloth and Spline Except #992M-999KD Apollo

Part#	Quantity (see note below)	Size	Price Each	Amount
		_____ " width x _____ " height		
891-999-3		Less than 10 charge	\$ _____	
891-999-1		Less than 5 charge	\$ _____	
891-999-2		Top Hung System	\$ _____	
Note: Minimum 2 screens per size & color			TOTAL	
			FREIGHT	

I understand that this material is not regular stock, but custom made to specifications as stated above. I understand and accept the condition that this material is NON RETURNABLE and NON-CANCELABLE. No freight charges on orders of 125 or more in assorted styles or sizes. **There is an additional packaging charge per screen when ordered in less than 10 or 5 per size per color.** IT IS THE RESPONSIBILITY OF THE CUSTOMER TO INSPECT FOR DAMAGE, AND MAKE THE CLAIM WITH THE CARRIER, AS WE ARE NOT RESPONSIBLE FOR DAMAGE.

***Please Note*: Carrier charges continue to fluctuate. Please call for delivery charges.**

Signature of Authorized Buyer _____ Buyer Phone _____

Title _____

Steel Custom Patio Screen Doors

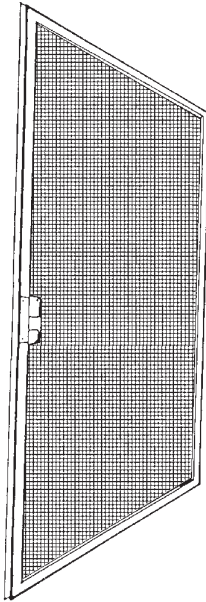

- Vinyl Bug Flap (Standard)
- Reversible for right or left hand doors
- Available in Gray or Charcoal Fiberglass Cloth (Standard)
- Replaces Patio Screen Doors with 1/16" to 3/16" sill/track bead height
- Each door includes: latch, keeper, rollers, bug seal and instructions
- Spring loaded latch will not break when door is slammed
- Custom made to fit width and height openings
- Frame size is 1/2" thick x 1-5/8" wide
- Frame size is 1-3/4" thick x 2" wide (Boss Steel Heavy Duty)
- Additional charges apply for steel rollers.
- Additional charges apply for stainless steel rollers & coastal hardware.
- Additional charges apply for aluminum wire.
- Additional charges apply for woolpile.
- Freight: FOB Shipping Point

FREIGHT PRE-PAID!
 on 125+ combination of all styles, sizes and colors.
 WITHIN CONTINENTAL UNITED STATES EXCLUDES ALASKA & HAWAII

Top Hung System
Now Available for Top Rolling Application!
 Includes top hung adapter & track. Additional charges apply.

Steel Custom Made Patio Screen Doors ENTERPRISE - 991M-999 (Standard)

Made of .019 Gauge Roll form Steel
 Colors Available: Gray, White, Almond, Beige, Sandstone, Bronze

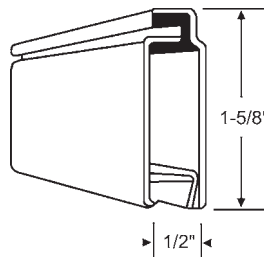

PRE-ASSEMBLED & KNOCKED DOWN

Width x Height
up to 33" x up to 83"
up to 39" x up to 83"
up to 51" x up to 83"
up to 61" x up to 83"
up to 33" x up to 105"
up to 39" x up to 105"
up to 51" x up to 105"

Steel Custom Made Patio Screen Doors BOSS - 997M-999 (Heavy Duty)

Made of .019 Gauge Roll form Steel
 Colors Available: Gray, White, Almond, Bronze

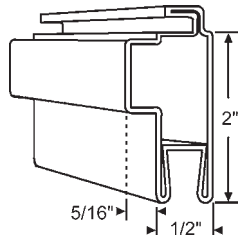

PRE-ASSEMBLED & KNOCKED DOWN

Width x Height
up to 33" x up to 83"
up to 39" x up to 83"
up to 51" x up to 83"
up to 61" x up to 83"
up to 33" x up to 105"
up to 39" x up to 105"
up to 51" x up to 105"
up to 61" x up to 105"

Steel Custom Made Patio Screen Doors are not Available with Deephead and Deepsill.

Freight on all doors will be prepaid on 125+ combination of all styles, sizes, and colors.
 Within Continental United States. Excludes Alaska & Hawaii

Pre-Assembled Steel & Aluminum Roll Form Doors are sold either 10 per color per size or 5 per color per size. Any quantity other than a multiple of 10 or 5 will be assessed with a single packaging charge per screen.

CARRIER CHARGES CONTINUE TO FLUCTUATE. PLEASE CALL FOR DELIVERY CHARGES

Aluminum Custom Patio Screen Doors

FREIGHT PRE-PAID!
 on 125+ combination of all styles, sizes and colors.
 WITHIN CONTINENTAL UNITED STATES EXCLUDES ALASKA & HAWAII

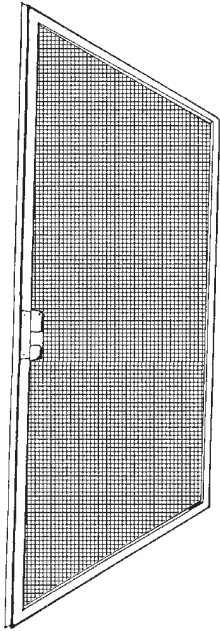

- Vinyl Bug Flap (Standard)
- Reversible for right or left hand doors
- Available in Gray or Charcoal Fiberglass Cloth (Standard)
- Replaces patio screen doors with 1/16" to 3/16" sill/track bead height
- Each door includes: latch, keeper, rollers, bug seal and instructions
- Spring loaded latch will not break when door is slammed
- Custom made to fit width and height openings
- Frame size is 1/2" thick x 1-5/8" wide
- Additional charges apply for steel rollers.
- Additional charges apply for stainless steel rollers & coastal hardware.
- Additional charges apply for aluminum wire.
- Additional charges apply for woolpile.
- Freight: FOB Shipping Point

Top Hung System
Now Available for Top Rolling Application!
 Includes top hung adapter & track. Additional charges apply.

Aluminum Custom Made Patio Screen Doors APOLLO - #992M-999

Made of .038 Gauge Roll form Aluminum
 Colors Available: Mill, White, Almond, Bronze

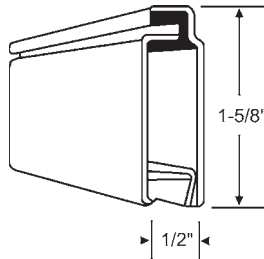

PRE-ASSEMBLED*

Width x Height
up to 33" x up to 83"
up to 39" x up to 83"
up to 51" x up to 83"
up to 61" x up to 83"
up to 33" x up to 105"
up to 39" x up to 105"
up to 51" x up to 105"

KNOCKED DOWN - #992M-999KD

Width x Height
24" to 30" x up to 80"
31" to 36" x up to 80"
37" to 48" x up to 80"
49" to 60" x up to 80"
24" to 30" x up to 96"
31" to 36" x up to 96"
37" to 48" x up to 96"
49" to 60" x up to 96"

A more cost effective way to order Patio Screen Doors
Save on Freight Costs • Less Storage Space Needed • Build as You Need

Freight on all doors will be prepaid on 125+ combination of all styles, sizes, and colors.
 Within Continental United States. Excludes Alaska & Hawaii.

Pre-Assembled Steel & Aluminum Roll Form Doors are sold either 10 per color, per size or 5 per color per size. Any quantity other than a multiple of 10 or 5 will be assessed with a single packaging charge per screen.

CARRIER CHARGES CONTINUE TO FLUCTUATE. PLEASE CALL FOR DELIVERY CHARGES.

Aluminum Knocked Down Patio Screen Doors

APOLLO Aluminum Rollform

- Frame size is 1/2" thick x 1-5/8" wide
- Reversible for right or left hand doors
- Made of .038 Gauge Rollform Aluminum
- Above doors are WITHOUT cloth or spline
- Spring loaded latch will not break when door is slammed
- Each door includes: latch, keeper, rollers and bug seal.
- Comes standard with nylon wheels.
- Replaces Patio Screen Doors with 1/16" to 3/16" sill/track bead height
- Additional charges apply for steel rollers.

Note: Maximum cut is 1/2" from each end of width, without having to re-drill hole.

COMBINE SIZES TO GET QUANTITY DISCOUNTS

Part #	Size	Color
92-1KD	30" x 81"	Mill
92-2KD	30" x 81"	Bronze
92-3KD	30" x 81"	White
92-4KD	36" x 81"	Mill
92-5KD	36" x 81"	Bronze
92-6KD	36" x 81"	White
92-7KD	48" x 81"	Mill
92-8KD	48" x 81"	Bronze
92-9KD	48" x 81"	White

The Above Screen Frame Uses .140 - 9/64" Spline

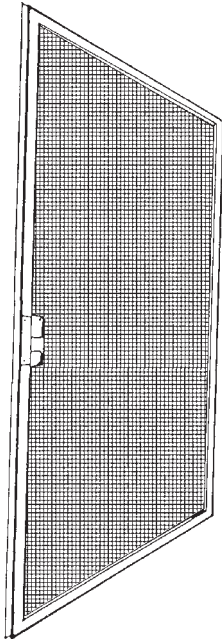
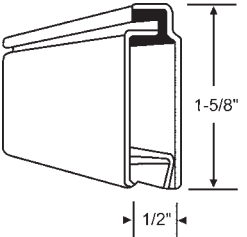
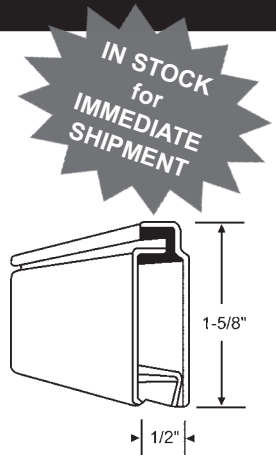

Aluminum Custom Patio Screen Doors

GEMINI Custom Extruded 999M-999

- Vinyl Bug Flap (Standard)
- Reversible for right or left hand doors
- Available in Gray or Charcoal Fiberglass Cloth (Standard)
- Available in Mill, Bronze, Almond, White, Beige
- Replaces Patio Screen Doors with 1/16" to 3/16" sill/track bead height
- Each door includes: latch, keeper, rollers, bug seal and instructions
- Spring loaded latch will not break when door is slammed
- Custom made to fit width and height openings
- Prices are for Standard Patio Screen Doors
- Frame size is 1/2" thick x 1-5/8" wide
- Additional charges apply for steel rollers.
- Additional charges apply for stainless steel rollers & coastal hardware.
- Additional charges apply for aluminum wire.
- Additional charges apply for woolpile.
- Freight: FOB Shipping Point

Made of .040 Gauge Extruded Aluminum

Width x Height
up to 33" x up to 83"
up to 39" x up to 83"
up to 51" x up to 83"
up to 61" x up to 83"
up to 33" x up to 103"
up to 39" x up to 103"
up to 51" x up to 103"
up to 61" x up to 103"

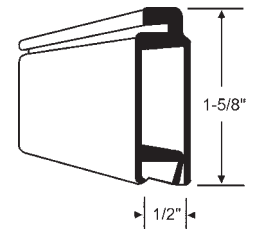

**Top Hung System
Now Available for Top
Rolling Application!**
Includes top hung adapter & track. Additional charges apply.

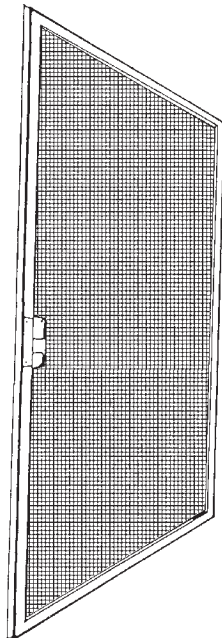

Note: Gemini doors are available in K/D form.

Freight on all doors will be prepaid on 125+ combination of all styles, sizes, and colors. Within Continental United States. Excludes Alaska & Hawaii.

Pre-Assembled Steel & Aluminum Roll Form Doors are sold either 10 per color, per size or 5 per color per size. Any quantity other than a multiple of 10 or 5 will be assessed with a single packaging charge per screen.

CARRIER CHARGES CONTINUE TO FLUCTUATE. PLEASE CALL FOR DELIVERY CHARGES.

Screen Hardware

Aluminum Custom Patio Screen Doors

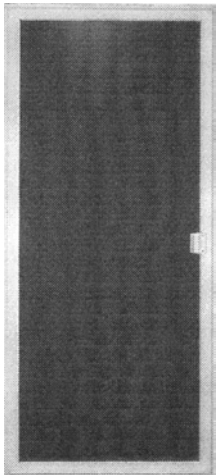

TITAN

Custom Extruded
995M-999 - Classic

998M-999 - Contemporary

- Frame size 1/2" x 2" wide • Reversible for right or left hand doors
- Custom made to fit width and height openings
- Made of heavy duty .040 gauge extruded aluminum
- Available In mill, white, bronze, almond and beige
- Available In two designs: classic and contemporary
- Comes standard with top adjusting nylon roller, upgraded handle system, and vinyl bug flap
- Each door includes: latch, keeper, and instructions
- Affordable upgrade from a roll formed door
- Additional charges apply for steel rollers.
- Additional charges apply for stainless steel rollers & coastal hardware.
- Additional charges apply for aluminum wire.
- Additional charges apply for woolpile.
- Freight: FOB Shipping Point



PRE-ASSEMBLED*

Width x Height
up to 33" x up to 83"
up to 39" x up to 83"
up to 51" x up to 83"
up to 61" x up to 83"
up to 33" x up to 103"
up to 39" x up to 103"
up to 51" x up to 103"
up to 61" x up to 103"

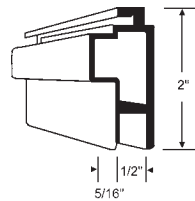

Classic Design

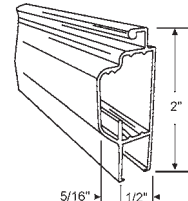

Contemporary Design

**Top Hung System
Now Available for Top
Rolling Application!**
Includes top hung adapter &
track. Additional charges apply.

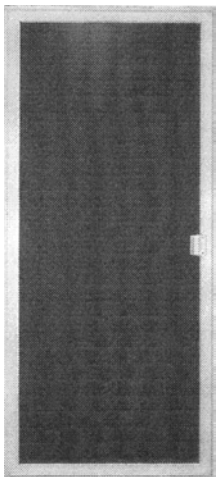

THE MOOSE™

Custom Extruded
996-999

A Good Substitute to Replace Andersen Screen Door

- Available in mill, white, almond and bronze
- Features our own premium locking handle and strike
- Offer your customers the ultimate upgrade in a rolling patio door screen
- Especially well designed to match the profiles of the best wood patio doors
- Rolls quietly and effortlessly on steel ball bearing wheels that can easily adjusted to fit your opening
- Enhance your product image with our heavy duty frame design, with walls a full .050" thick
- Individually packed with all necessary hardware and installation guidelines
- Additional charges apply for steel rollers.
- Additional charges apply for stainless steel rollers & coastal hardware.
- Additional charges apply for aluminum wire.
- Additional charges apply for woolpile.
- Freight: FOB shipping point

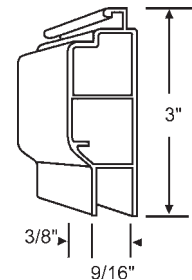

PRE-ASSEMBLED*

Width x Height
up to 33" x up to 83"
up to 39" x up to 83"
up to 51" x up to 83"
up to 61" x up to 83"
up to 33" x up to 115"
up to 39" x up to 115"
up to 51" x up to 115"
up to 61" x up to 115"

**Top Hung System
Now Available for Top
Rolling Application!**
Includes top hung adapter &
track. Additional charges apply.



Note: Both Titan and Moose doors are available in K/D form.

Freight on all doors will be prepaid on 125+ combination of all styles, sizes, and colors. Within Continental United States. Excludes Alaska & Hawaii.

Pre-Assembled Steel & Aluminum Roll Form Doors are sold either 10 per color per size or 5 per color, per size. Any quantity other than a multiple of 10 or 5 will be assessed with a single packaging charge per screen.

CARRIER CHARGES CONTINUE TO FLUCTUATE. PLEASE CALL FOR DELIVERY CHARGES.

Steel Multi-Fit Patio Screen Doors

COMBINE SIZES TO GET QUANTITY DISCOUNTS

Note: This is a painted galvanized steel product. No warranty is given, written, or inferred against rusting, corrosion or reactions against dissimilar metals.

- Made of .019 gauge rollform steel
- Reversible for right or left hand doors
- Replaces 90% of existing patio screen doors
- Steel wheels available, add \$2.25 to cost of screen (Standard on Heavy Duty Door)
- Available in gray or charcoal fiberglass cloth - standard
- Bright and charcoal aluminum wire available add 35% to cost of screen
- Complete with latch, door pull, keeper, non-adjusting nylon rollers, bug strip and instructions
- Comes with heavy duty top & bottom expanders allowing the doors to adjust from 78" to 80" for a custom fit
- Tear away vinyl bug flap is designed for hand peeling to custom fit your door
- Easy access field adjustments for quick installation
- Patio doors are 1/2" thick x1-5/8" wide (Standard) or 3/4" x 2" (Heavy Duty)
- Freight: FOB shipping point

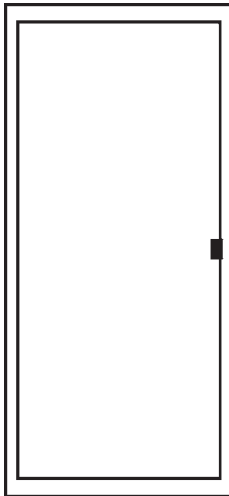

Standard

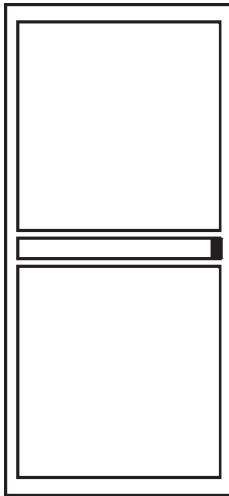

Heavy Duty

(Includes 2 Removable Push Bars, Steel Rollers and HD Latching Handle)

STANDARD PRE-ASSEMBLED*

Part #	Size	Color
93-1	30"	Gray
93-2	36"	Gray
93-3	48"	Gray
93-4	60"	Gray
93-5	30"	Earthtone Bronze
93-6	36"	Earthtone Bronze
93-7	48"	Earthtone Bronze
93-8	60"	Earthtone Bronze
93-9	30"	White
93-10	36"	White
93-11	48"	White
93-12	60"	White

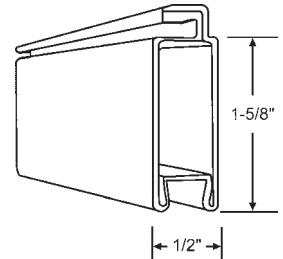

HEAVY DUTY PRE-ASSEMBLED*

Part #	Size	Color
997-1	30"	Gray
997-2	36"	Gray
997-3	48"	Gray
997-5	30"	Earthtone Bronze
997-6	36"	Earthtone Bronze
997-7	48"	Earthtone Bronze
997-9	30"	White
997-10	36"	White
997-11	48"	White

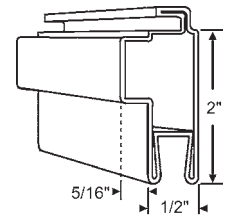

Freight on all doors will be prepaid on 125+ combination of all styles, sizes, and colors. (Within Continental United States. Excludes Alaska & Hawaii)

Pre-Assembled Steel & Aluminum Roll Form Doors are sold either 10 per color per size or 5 per color, per size. Any quantity other than a multiple of 10 or 5 will be assessed with a single packaging charge per screen.

CARRIER CHARGES CONTINUE TO FLUCTUATE. PLEASE CALL FOR DELIVERY CHARGES.

Top Hung System for Top Rolling Application



Top Hung Adapter

Part #	Size	Color
90M-637W	30"	White
90M-638W	36"	White
90M-639W	48"	White



90M-640W

White
Top Hung Track
8 ft.

Screen Hardware

Retractable Screen Door Systems

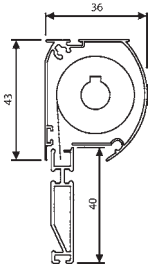

36mm Cassette

PETITE DESIGN - The petite design of the 36mm Retractable Screen makes it perfect for most door applications. This Retractable Screen is small enough to rest virtually unnoticed in the jamb area of most swing doors and in the meeting rail of most sliding Patio Doors. The standard 36mm cassette housing contains 54" of 18 x 16 screen fabric. The Genius TuffScreen series 36mm cassette housing contains 42" of 18 x 14 screen fabric.

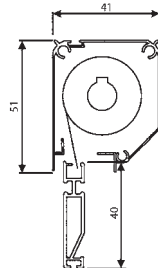

41mm Cassette

DELUXE DESIGN - This Deluxe Design 41mm Retractable Screen is stylish and has added rigidity for taller doors. It is best for larger/wider openings or anywhere you may need more screen. The standard 41mm cassette housing contains 66" of 18 x 16 screen fabric. The Genius TuffScreen series 41mm cassette housing contains 54" of 18 x 14 screen fabric.



SINGLE DOOR RETRACTABLE SCREEN SYSTEMS



Single Door

36MM SYSTEM			41MM SYSTEM	
Part #	Color	Maximum Opening	Part #	Maximum Opening
990-13W	White	42" x 84"	990-13W-41	60" x 84"
990-13B	Black	42" x 84"	990-13B-41	60" x 84"
990-13BRN	Brownstone	42" x 84"	990-13BRN-41	60" x 84"
990-14W	White	42" x 96"	990-14W-41	60" x 96"
990-14B	Black	42" x 96"	990-14B-41	60" x 96"
990-14BRN	Brownstone	42" x 96"	990-14BRN-41	60" x 96"

DOUBLE DOOR RETRACTABLE SCREEN SYSTEMS



Double Door

36MM SYSTEM		
Part #	Color	Maximum Opening
990-15W	White	72" x 84"
990-15B	Black	72" x 84"
990-15BRN	Brownstone	72" x 84"
990-16W	White	72" x 96"
990-16B	Black	72" x 96"
990-16BRN	Brownstone	72" x 96"

LARGE VERTICAL OPENING SYSTEMS



Garage Door

HEAVY DUTY DESIGN - The heavy duty design 46mm retractable screen is great for large vertical openings, such as garage doors, porch enclosures or for use within almost any large opening application. The Standard 46mm Cassette Housing contains 102" of 18 x 16 screen fabric.

46MM SYSTEM		
Part #	Color	Maximum Opening
990-45W	White	96" x 96"
990-46W	White	108" x 96"
990-47W	White	192" x 96"

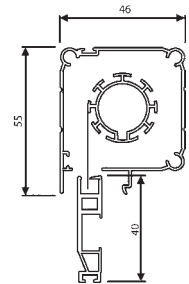

46mm Cassette

THRESHOLD TRANSITIONS

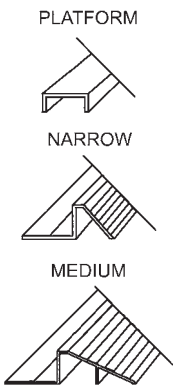

TRANSITIONS FOR 36MM AND 41MM SYSTEMS

Description	Clear Anodized	Bronze Anodized
Platform Transition	990-38CA	990-38DBZA
Narrow Transition	990-39CA	990-39DBZA
Medium Transition	990-40CA	990-40DBZA

Sold Min. 5 Lengths - 122" per Length - Can Mix and Match

SALESMEN SAMPLES



Part #	Size	Description
990-62	36mm	Counter Top Sample Door
990-19S	36mm	Single Door Sample
990-19D	36mm	Double Door Sample
990-41S	41mm	Single Door Sample
990-41D	41mm	Double Door Sample
990-42V	46mm	Vertical Window Sample for Garages

Part #	Quantity	Description
500-217	100/Bundle	Genius Consumer Brochures
500-218	100/Bundle	Genius Promotional Hanger
500-219		Color Option Sheet
500-220		Genius Instructional DVD

Other colors also available through special order: Silver, Almond, Adobe Gray, Hunter Green and Desert Tan.

Charcoal Fiberglass Screening is included as standard.

For TuffScreen (recommended for heavily traveled doorways), Solar Screen or Pet Screen options, please contact your account manager.

Screen Tools

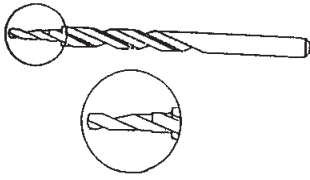

59-51

Step Drill. For plunger with 7/32" tip. High speed hardened steel step drill makes two diameter holes in one pass for a precise screen plunger fit.



59-44

Concave Roller/Cutter
Steel Wheel

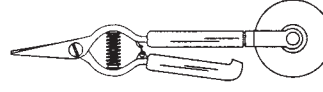

59-45

Cloth Cutter with Steel Wheel



Part #	Description
59-10	5/32" Wheel
59-10SP	1/16" Wheel

Plastic Roller and Housing

Screen Spline and Screen Wire Installation Tool

A professional tool with wood handle and steel enclosed ball bearing rollers. Use convex roller of installation tool to roll screen wire into slot of screen frame; use concave roller to roll spline into slot over screen wire to hold it tightly in place.



Part #	Description
59-4	Steel Rollers
59-4P	Plastic Rollers



Convex Roller



Concave Roller

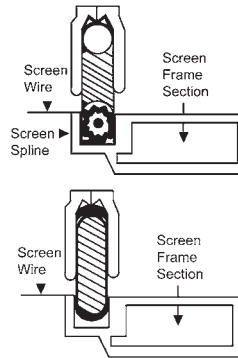

Screen Frame Notching Jig

**Easy to Use!
A Real Time Saver!**

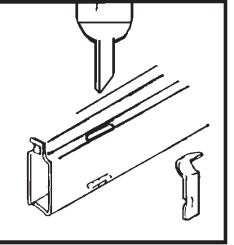
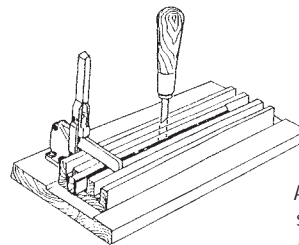

900-15853

The Screen Frame Notching Jig and Tool Assembly installs tension springs, slide locks, swivel and knife latches in aluminum window screen metal. The grooved wooden jig holds 5/16", 3/8" and 7/16" screen frame securely while you notch the metal with the notching tool.



900-15852
Notching Tool

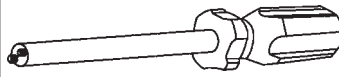

59-15
One-Way Screw Remover

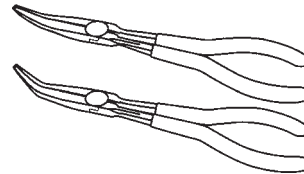

59-7

Long Reach Needle Pliers Set
2 piece 11" 20° offset & 45° angle
• Reach areas too tight for standard pliers
• Made from drop-forged, heat-treated steel

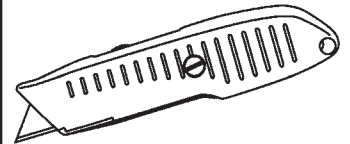

59-14
Utility Knife

- Professional Quality.
- Button Projects and Retracts Blade
- Sturdy Handle Provides Storage



59-23

6-in-1 Screwdriver.

Bits and tube are made of hardened steel. Lifetime Guarantee.



Phillips® #2 1/4" Nut Driver Phillips® #1 Slotted 9/32" 5/16" Nut Driver Slotted 3/16"

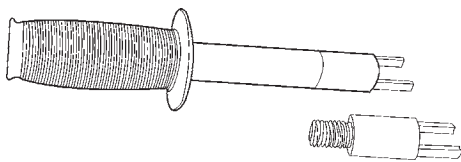

Part #	Fits	Tip Only
59-47	52-614 Roller Assy.	59-47T
59-47-1	52-613 and 52-675 Roller Assy.	59-47-1T
59-47-2	900-1285 Roller Assy.	59-47-2T

Roller Assembly Inserting Tool. Includes Tip.



Net Weight 9.4oz.

59-5

Alum-A-Lub Cleaner is the "All Purpose" lubricating cleaner that can be used on all products that stick or squeak. Alum-A-Lub assures ease of operation and a "Like New" appearance for metal windows, doors, locks, hinges, cabinets and more. Simply spray and wipe away dirt, grime and gummy residue left by other lubricants. A must for your shop, workroom, home, maintenance department or garage.

12 per case



Net Weight 11oz.

59-50

"L.C. Wax" Alumalub Aluminum Lubricant & Liquid Masking cleans and lubricates aluminum better than anything. Quick penetration/release and long lasting lubrication. Cleans corrosion and tarnish; protects from salt corrosion; reduces wear; stops squeaks, bumps, klunks, clinks.

12 per case