

# Patio Door Hardware

## Precision Bearing Roller Assembly for Patio Sliding Glass Door

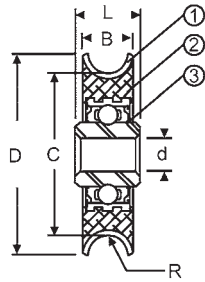

Part #	D	C	d	B	R	L
11-212	1-1/2"	1-1/4"	1/4"	5/16"	1/8"	3/8"
11-214	1-1/4"	1"	1/4"	5/16"	1/8"	3/8"

1. Outer Ring - Stainless Steel
2. Reinforced Nylon
3. Precision Bearing

### ABB Series Precision Bearing Stainless Steel Wheels

Completely new design that establishes a new level of quality for Patio Door Rollers. Design Highlights:

- Ideal for coastal applications
- Extremely smooth rolling
- Less operating force (motion to open/close)
- Less noise and vibrations
- Better corrosion resistance
- The Precision Bearing is factory greased and completely sealed
- The outer ring, that is the rolling surface of the wheel, is made of Stainless Steel to avoid any rust formation between the wheel and the track.
- Using composite nylon, the Precision Bearing is assembled with the outer ring by an injection molding process.



Part #	Wheel
11-227	1-1/2"

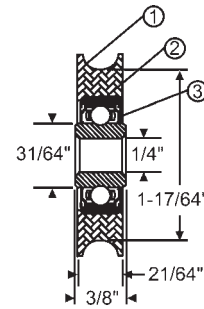

1. Outer Ring - Nylon
2. Reinforced Nylon
3. Precision Bearing

### MBB Series Precision Bearing Nylon Wheels

This is an upgraded Nylon wheel that is assembled with a precision bearing as in the ABB Series. The Nylon tire is injected with fiber glass reinforced Nylon. The competitive advantages of this wheel are similar to those for the ABB Series,

- Extremely smooth rolling
- Less operating force (motion to open/close)
- Less noise and vibrations
- Higher Load capacity of 65 Lbs. per wheel (compared to 45 Lbs. per wheel on a regular Nylon wheel)
- The Precision Bearing is factory greased and completely sealed

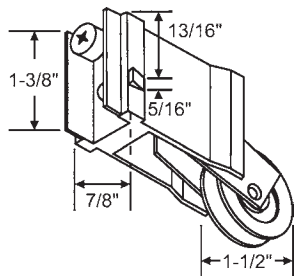

Part #	Size	Outer Ring
9-257SPB	1-1/2"	Stainless Steel
9-257NPB	1-1/2"	Nylon

Pan Am

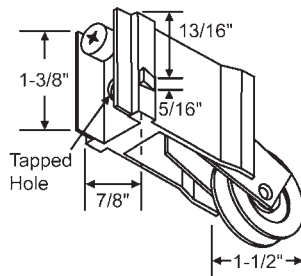

Part #	Size	Outer Ring
9-457SPB	1-1/2"	Stainless Steel
9-457NPB	1-1/2"	Nylon

Pan Am/AAA

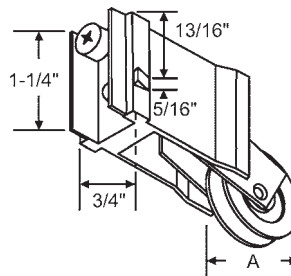

Part #	A	Outer Ring
9-247-1.25SPB	1-1/4"	Stainless Steel
9-247SPB	1-1/2"	Stainless Steel
9-247NPB	1-1/2"	Nylon

Yale Ogron

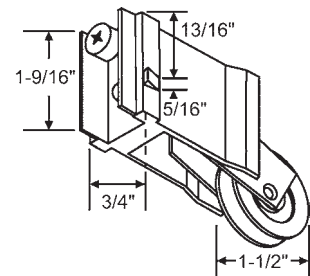

Part #	Size	Outer Ring
9-249SPB	1-1/2"	Stainless Steel
9-249NPB	1-1/2"	Nylon

Weathertite/Lawson

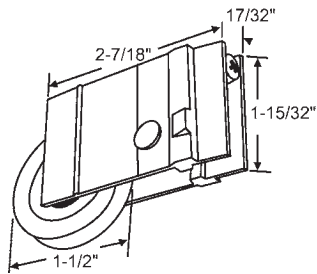

Part #	Size	Outer Ring
9-364SPB	1-1/2"	Stainless Steel
9-364NPB	1-1/2"	Nylon

Max. Width at Locking Tangs 31/32"  
Lawson/Wallace

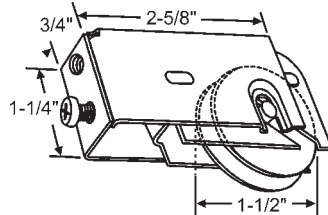

Part #	Size	Outer Ring
9-392SPB	1-1/2"	Stainless Steel

Max. Housing Thickness 3/4"  
Croft

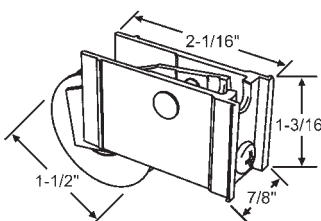

Part #	Size	Outer Ring
9-330SPB	1-1/2"	Stainless Steel

Security

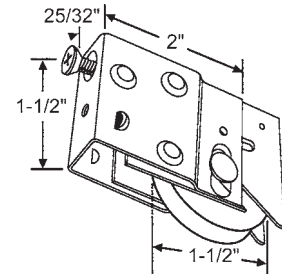

Part #	Size	Outer Ring
9-366SPB	1-1/2"	Stainless Steel

Max. Dimple Width 29/32"  
Max. Width at Locking Tangs 1"  
Binnings/Pan Am

## Precision Bearing Roller Assembly for Patio Sliding Glass Door

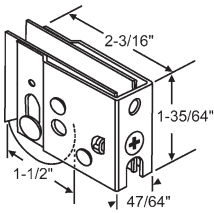

Part #	Size	Outer Ring
9-338SPB	1-1/2"	Stainless Steel

Maximum Width at Locking Tangs 7/8"  
Harcar/Keller/Pan Am

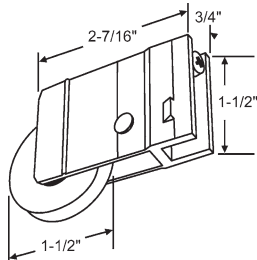

Part #	A	Outer Ring
9-453SPB	1-1/2"	Stainless Steel

Lawson

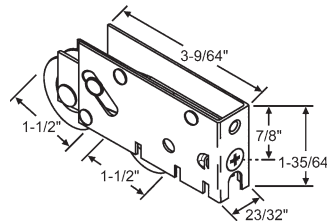

Part #	Size	Outer Ring
900-22693-SPB	1-1/2"	Stainless Steel
900-22693-NPB	1-1/2"	Nylon

PGT/Kinco

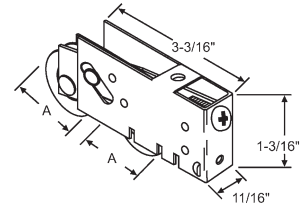

Part #	A	Outer Ring
9-443-1.25SPB	1-1/4"	Stainless Steel
9-443SPB	1-1/2"	Stainless Steel
9-443NPB	1-1/2"	Nylon

Nu-Air

### Your Roller Assembly Not Listed?

Call your sales representative and find out if we can furnish your particular patio door roller assembly with our Precision Bearing Roller. We have machine shop capabilities where we can supply many patio door roller assemblies equipped with our new Precision Bearing Roller.

## Stamped Glass Door Roller Assemblies

In Order by Wheel Diameter

27/32"

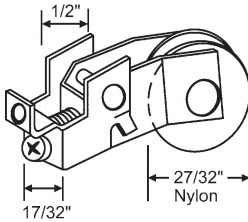

Part #	Wheel Type
9-291	Concave
9-291F	Flat

Used by Traco

7/8"

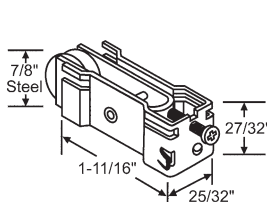

9-295

Acorn

1"

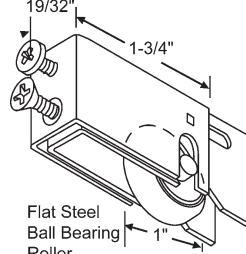

Flat Steel  
Ball Bearing  
Roller

900-9469

Capitol/Remington

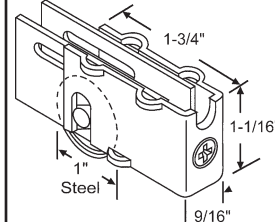

Part #	Wheel Type
9-305	Flat w/Tapered Edges
9-305SP	Concave

Capitol

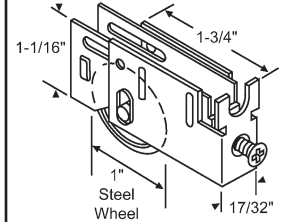

Part #	Wheel Type
900-10138	Flat
9-333	Concave

Capitol/Remington

1-1/16"

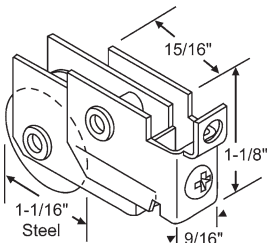

9-306

Capitol/Remington

1-1/8"

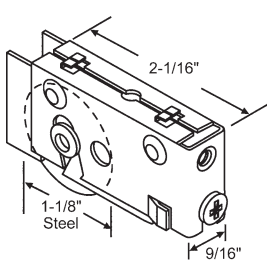

9-218

Max. Dimple Width 3/4"

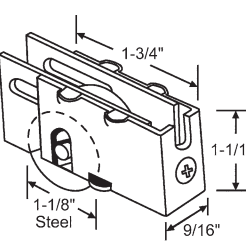

9-273

Remington

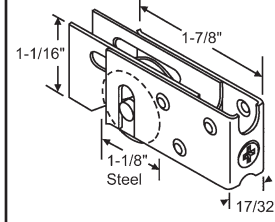

9-325

Max. Dimple Width 19/32" No  
Longer Available. Use: 900-14295C  
Metal Industries/  
Capitol

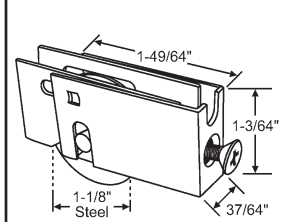

900-14295C

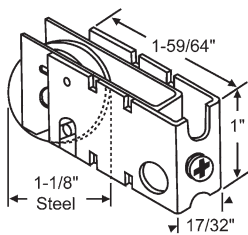

900-16711

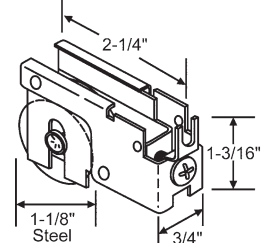

9-289

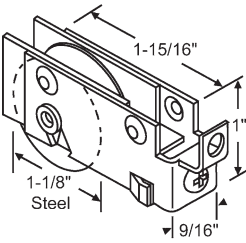

9-324

Max. Dimple Width 7/8"

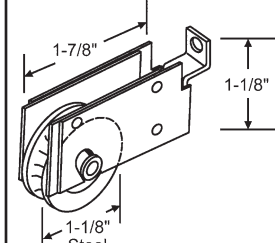

9-293

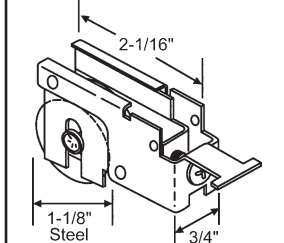

9-292

# Patio Door Hardware

## Stamped Glass Door Roller Assemblies

In Order by Wheel Diameter

1-1/4"

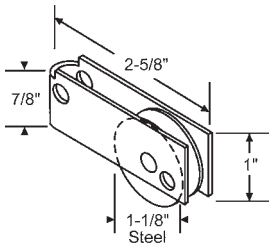

**9-279**  
Top Hole  
Capitol

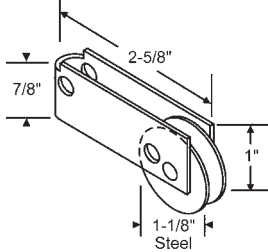

**9-279-1**  
Bottom Hole  
Capitol

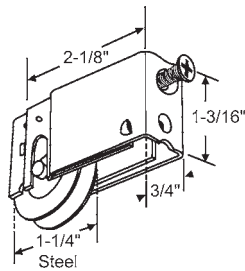

**900-10106**  
Nu-Air

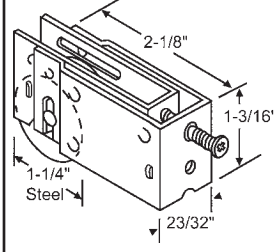

**900-15153**  
Dimple Width 3/4"  
Tang Width 7/8"

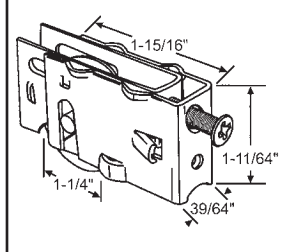

**900-10095**  
Max. Dimple Width 13/16"  
Better-Bit

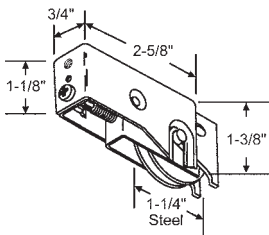

**9-238**

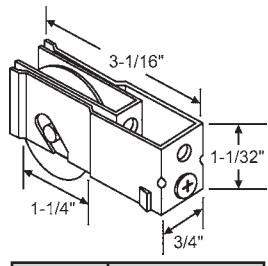

Part #	Wheel Type
9-258	Steel
9-258N	Nylon

Daryl

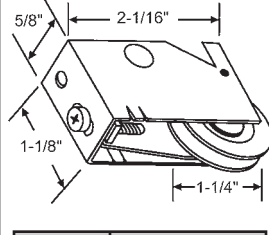

Part #	Wheel Type
9-245	Steel
9-245N	Nylon
9-245SS	Stainless Steel

Crossly

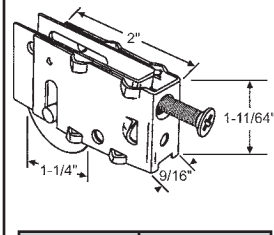

Part #	Wheel Type
900-7662	Steel
900-7662SS	Stainless Steel

Max. Dimple Width 3/4"  
Acorn/Arundel

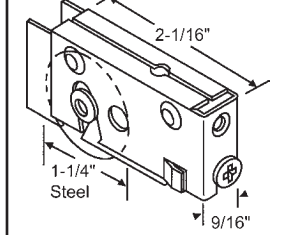

**900-13579**  
Max. Dimple Width 23/32"  
Arundel

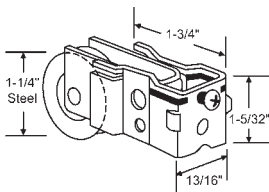

**9-215**  
Acorn

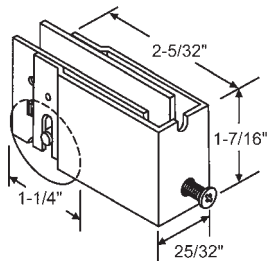

Part #	Wheel Type
9-331	Steel
9-331SS	Stainless Steel

Pennco

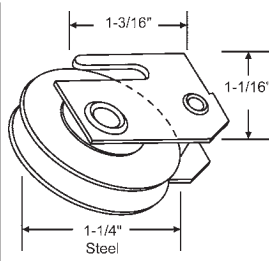

**9-209**

Ador Hi-Lite

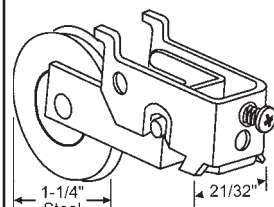

**9-209A**

Ador Hi-Lite

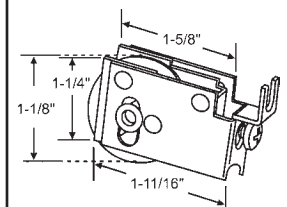

Part #	Wheel Type
900-13138	Steel
900-13138N	Nylon

Look

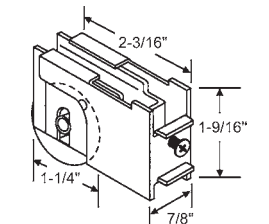

Part #	Wheel Type
9-266	Steel
9-266SS	Stainless Steel

Peachtree

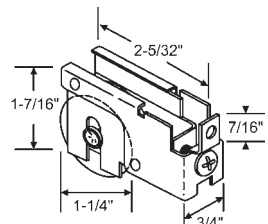

Part #	Wheel Type
9-200	Steel
9-200N	Nylon

9-200

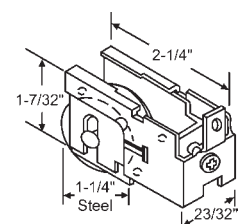

**9-299**

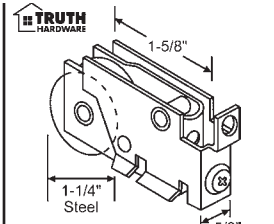

**9-286**

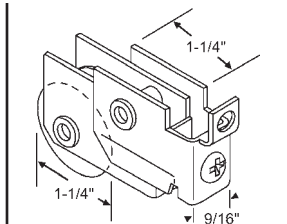

Part #	Wheel Type
9-216	Steel
9-216P	Nylon

9-216

## Stamped Glass Door Roller Assemblies

In Order by Wheel Diameter

1-1/4"

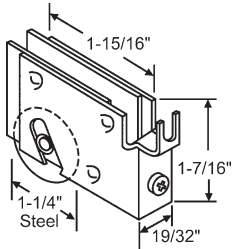

Part #	Wheel Type
9-294	Steel
9-294N	Nylon

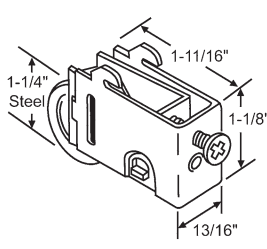

**900-10098A**

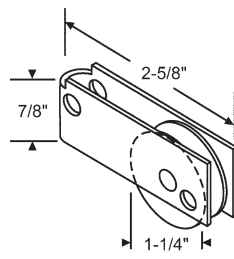

Part #	Wheel Type
9-262M	Steel
9-262	Nylon

Top Hole

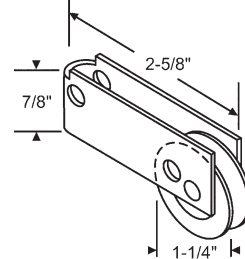

Part #	Wheel Type
9-263M	Steel
9-263	Nylon

Bottom Hole

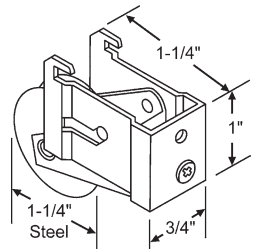

**900-9498**

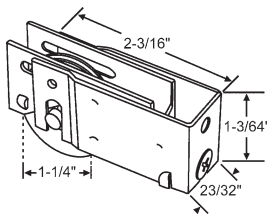

**900-18649**

Steel Wheel/Steel Body 7/8" Tab Width

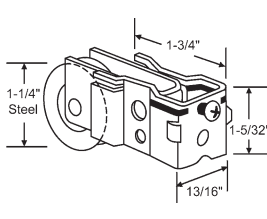

**9-215D**

Acorn

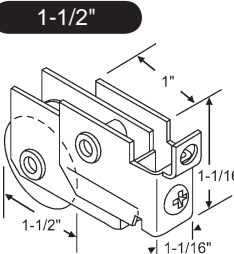

Part #	Wheel Type
9-217M	Steel
9-217P	Nylon

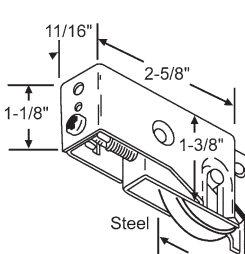

**9-341**

Lenahan/Daryl

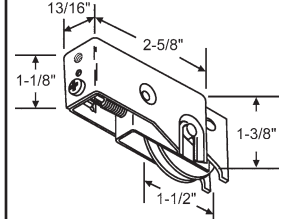

Part #	Wheel Type
9-260M	Steel
9-260	Nylon

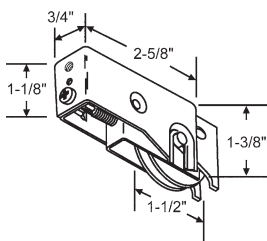

Part #	Wheel Type
9-261	Steel
9-261SS	Stainless Steel

Air Control/Keller

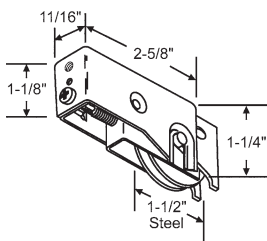

**9-318**

Jones

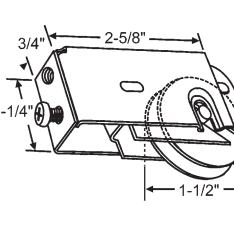

Part #	Wheel Type
9-392	Steel
9-392SS	Stainless Steel

Max. Housing Thickness 3/4"

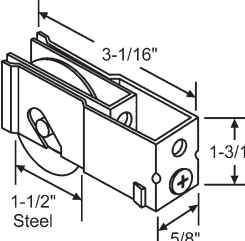

**9-250**

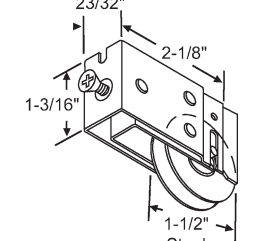

**900-10116**

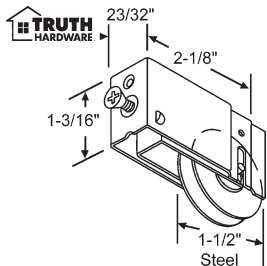

**900-10107**

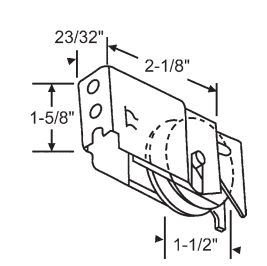

Part #	Wheel Type
9-304	Steel

Maximum Width at Locking Tangs 57/64"

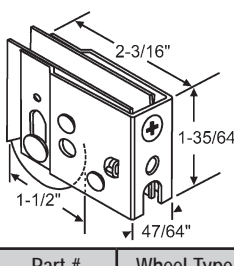

Part #	Wheel Type
900-11287	Steel
900-11287N	Nylon
900-11287SS	Stainless Steel

Maximum Width at Locking Tangs 7/8"  
Crown/Lawson

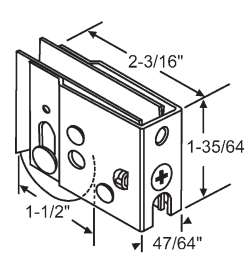

Part #	Wheel Type
9-338N	Nylon
9-338	Steel
9-338SS	Stainless Steel

Maximum Width at Locking Tangs 7/8"  
Harcar

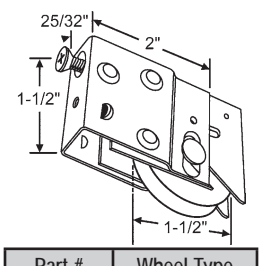

Part #	Wheel Type
9-366	Steel
9-366N	Nylon
9-366SS	Stainless Steel

Max. Dimple Width 29/32"  
Max. Width at Locking Tangs 1"  
Binnings/Pan Am

# Patio Door Hardware

## Stamped Glass Door Roller Assemblies

In Order by Wheel Diameter

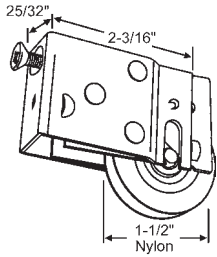

Part #	Wheel Type
9-327	Nylon
9-327S	Steel

Max Dimple Width 27/32". Max Width at Locking Tangs 59/64"

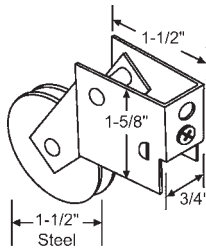

**9-235**  
Keller

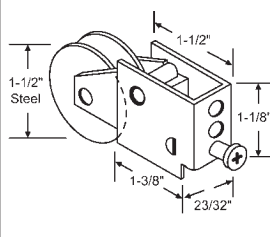

**9-211**  
Harcar

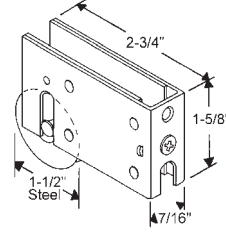

**9-377**  
Crown Industries

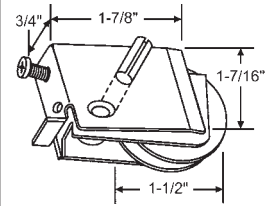

Part #	Wheel Type
9-255	Nylon
9-255M	Steel

Lumidor

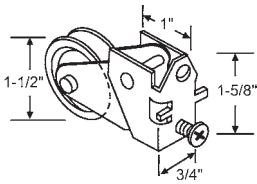

Part #	Wheel Type
9-233	Steel
9-233N	Nylon

Stanley

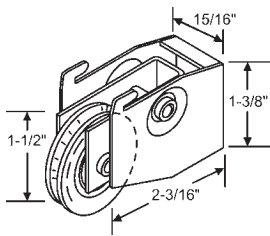

Part #	Wheel Type
9-220	Nylon
9-229	Steel

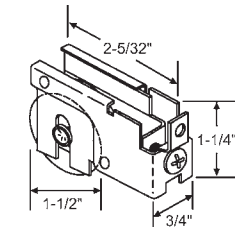

Part #	Wheel Type
9-201	Steel

Dimple Width 25/32"

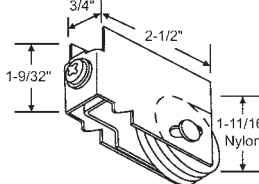

**9-207N**  
Arcadia

## Die Cast Roller Assemblies

5/8"

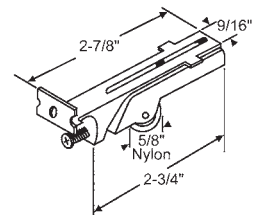

**9-202**  
Flat Roller

7/8"

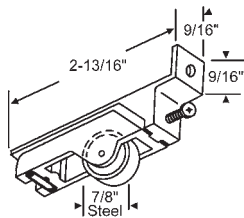

**9-277**  
Atlas/Portalume

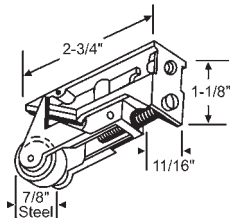

**9-303**  
Flat Roller, Die Cast

1-1/4"

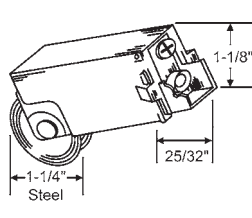

**9-214**  
Binnings

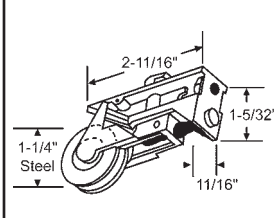

**9-276**

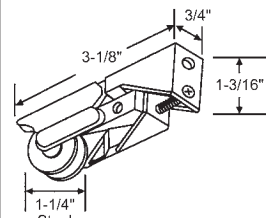

Part #	Wheel Type
9-248	Steel
9-248SS	Stainless Steel

## Extruded Glass Door Roller Assemblies

1-1/2"

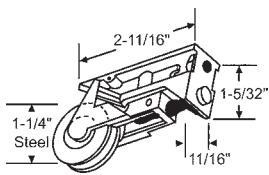

**9-275**

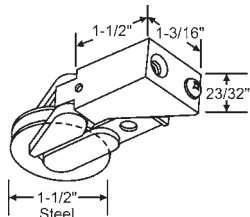

**9-268**  
Die Cast  
Keller/Air Control

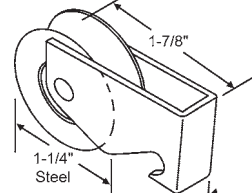

**900-11663**  
Silverline

1-1/4"

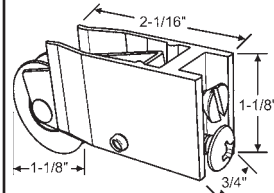

**900-11663A**  
with Corner Housing and Screw.  
Silverline

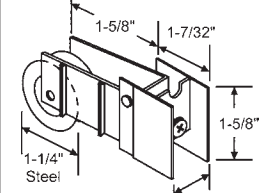

**9-231**  
Peachtree





## Screen Door Roller Assemblies

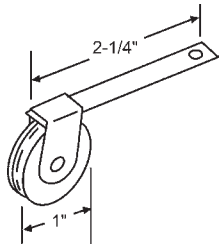

Part #	Wheel Type
10-356	Nylon
10-392	Steel

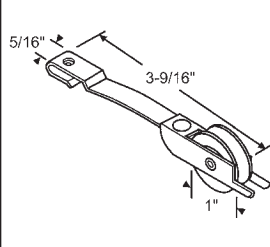

Part #	Wheel Type
10-407	Nylon
10-407M	Steel

Columbia

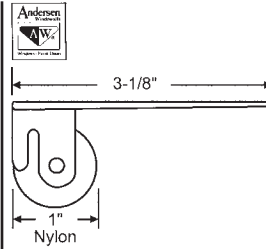

750-1274004

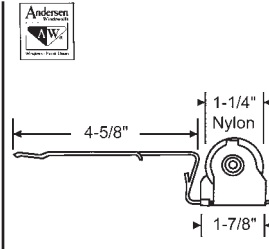

750-1997063  
Upper

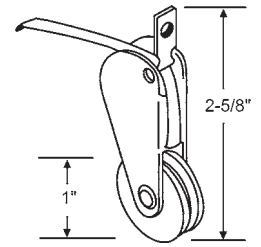

Part #	Wheel Type
10-312	Nylon
10-372	Steel

Metal Industries

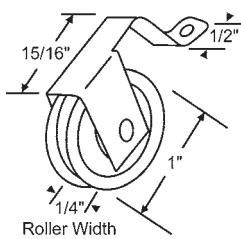

Part #	Wheel Type
10-396	Nylon
10-396M	Steel

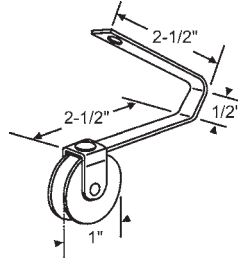

10-388  
Nylon

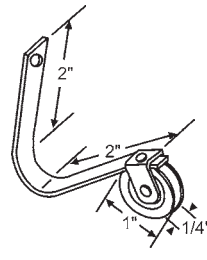

Part #	Wheel Type
10-359	Nylon
10-359M	Steel

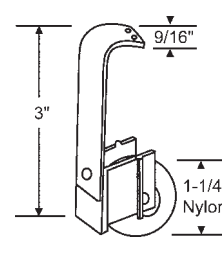

10-353  
Peachtree

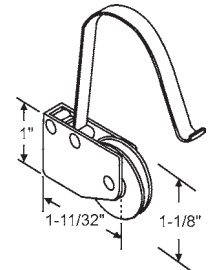

10-414  
1-1/8" Dia. Steel Ball Bearing Wheel. Used with Corner 16-301

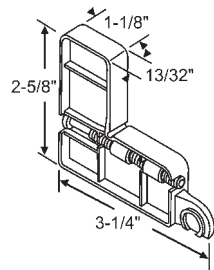

16-301  
Corner for 10-414

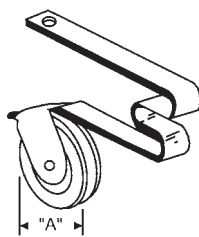

Part #	"A"	Wheel Type
10-358	7/8"	Nylon
10-314	1"	Nylon
10-371	1"	Steel

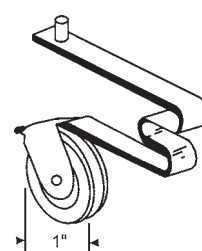

Part #	Wheel Type
10-306	Nylon
10-306M	Steel

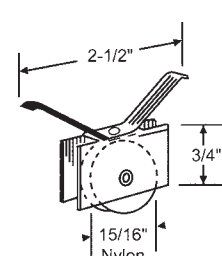

10-300  
Keller

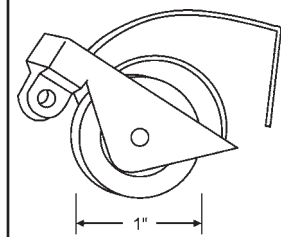

Part #	Wheel Type
10-348	Nylon
10-348M	Steel

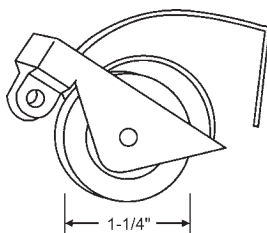

Part #	Wheel Type
10-360	Nylon
10-360M	Steel

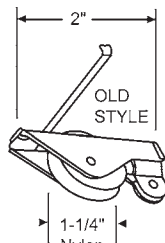

10-368  
Acorn

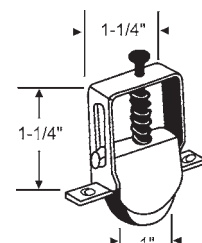

Part #	Wheel Type
10-343	Nylon
10-343M	Steel

Mounting Holes 1-11/16"  
Columbia

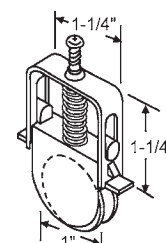

Part #	Wheel Type
10-403	Nylon
10-403M	Steel

Columbia

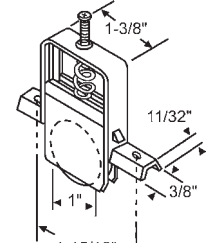

10-404  
Nylon  
Columbia

# Patio Door Hardware

## Screen Door Roller Assemblies

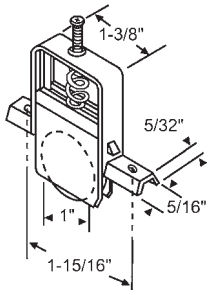

Part #	Wheel Type
10-406	Nylon
10-406M	Steel

Columbia

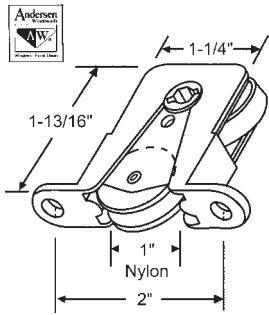

**750-1274104**

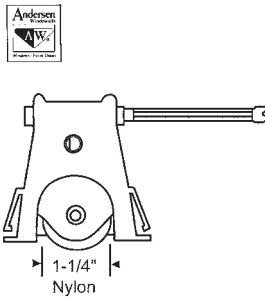

**750-1997310**  
Lower

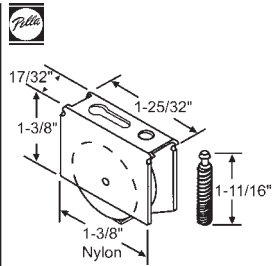

**900-10862**

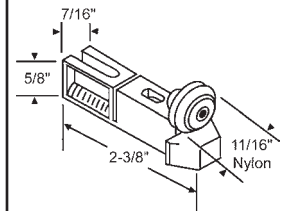

**10-365**

Ador Hi-Lite

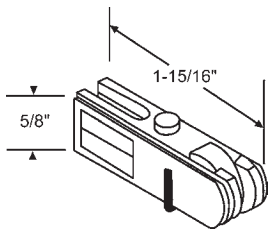

**10-326**

Ador Hi-Lite

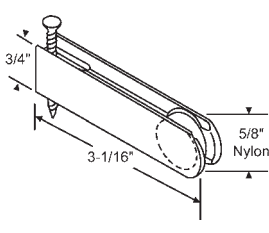

**10-401**

Weathershield

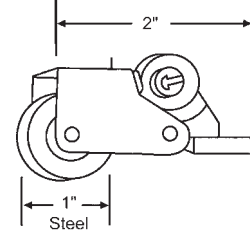

Part #	Hand
900-12879LH	LH (shown)
900-12879RH	RH

Adjustable Roller  
Ritescreen

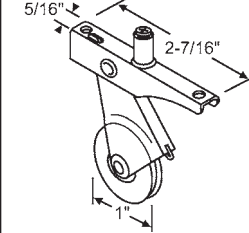

Part #	Wheel Type
10-410	Steel
10-410P	Nylon
10-410SS	Stainless Steel

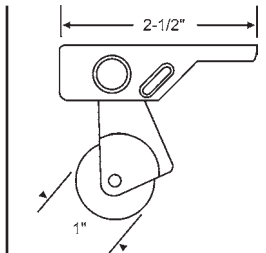

Part #	Wheel Type
900-20072	Nylon
900-20072S	Steel

Ritescreen/Metal  
Industries

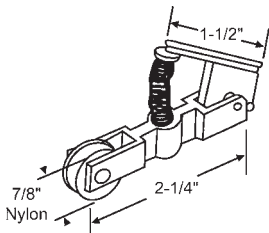

**10-302**

Chrysler

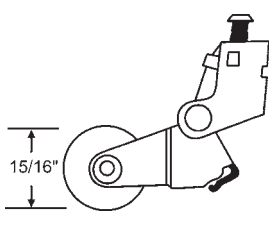

Part #	Wheel Type
10-367	Nylon
10-367M	Steel

Jim Walters

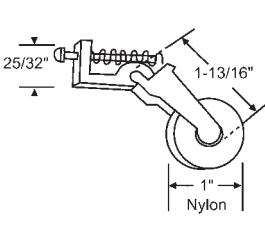

**900-9705**

Nylon Wheel and Housing  
Yale Ogron

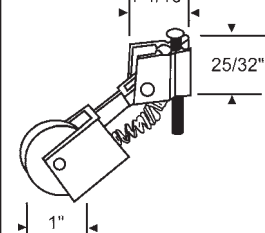

**10-313**

Miller

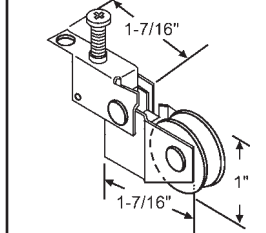

Part #	Wheel Type
900-19216	Nylon
900-19216M	Steel

Moss

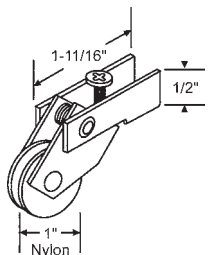

**10-435**

Peachtree

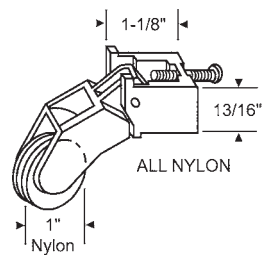

**10-394**

Peachtree

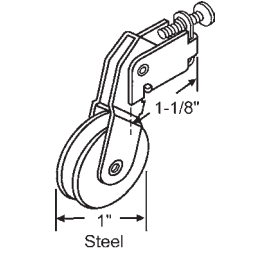

**10-394M**

Peachtree

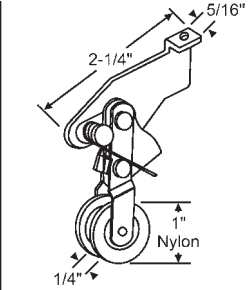

**10-395**

Use with 900-14766  
Weather-Barr



**900-17614**  
Adjustment Sleeve for 10-395



**900-17615**  
Adjustment Screw for 10-395

## Screen Door Roller Assemblies

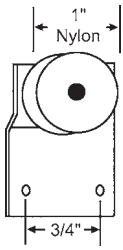

**900-14766**  
Top Hung. Use with 10-395  
Weather-Barr

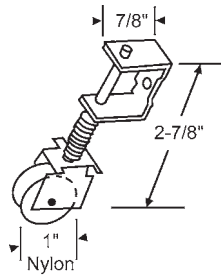

**10-351**  
Crossly

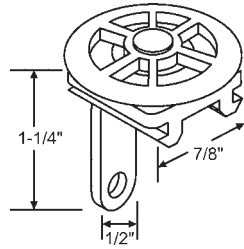

**900-9068**  
Peachtree

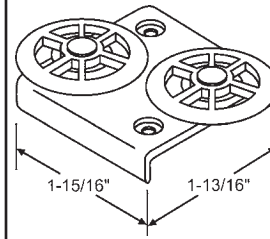

**900-14226**  
Peachtree

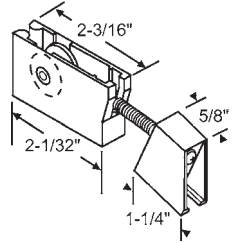

**10-417**  
Old Style  
Baltimore Thermal

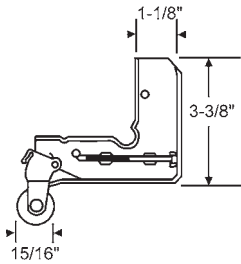

Part #	Wheel Type
10-373	Nylon
10-373M	Steel

Maximum Corner Thickness 7/16"  
Jim Walters

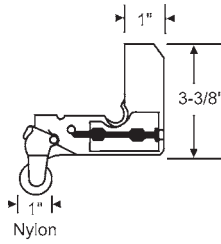

**10-399**  
Maximum Corner Thickness  
13/32"  
Acorn

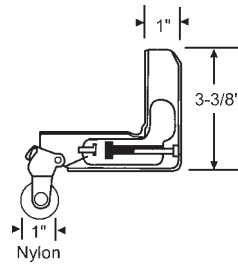

**10-355**  
Maximum Corner Thickness  
11/32"  
Jim Walters

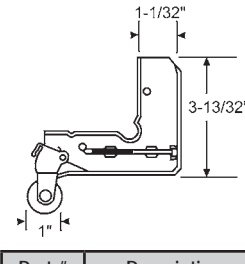

Part #	Description
10-398	Nylon for Steel Doors
10-398A	Nylon for Aluminum Doors
10-398S	Steel for Steel Doors
10-398AS	Steel for Aluminum Doors

Corner Thickness 7/16"  
Ritescreen

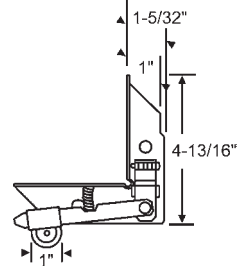

Part #	Hand
10-402LH	LH (shown)
10-402RH	RH

No Longer Available  
Columbia

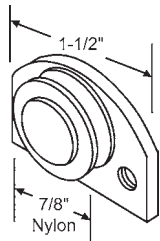

**10-301**

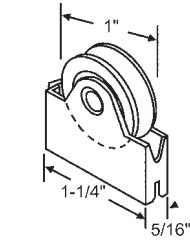

Part #	Wheel Type
10-408	Nylon
10-408M	Steel

Part of 10-402LH/RH  
Columbia

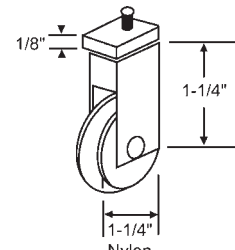

**10-318**  
Nylon

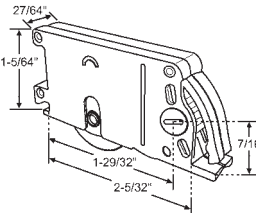

**10-443**  
1" Metal Wheel. Adjustable  
Vertical Roller 15/64" thru 7/8"  
Highest Position  
Norco

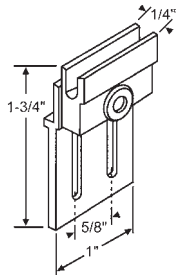

**10-455**  
Aluminum Bracket w/Nylon Guide  
Croft

## Track and Roller Assembly

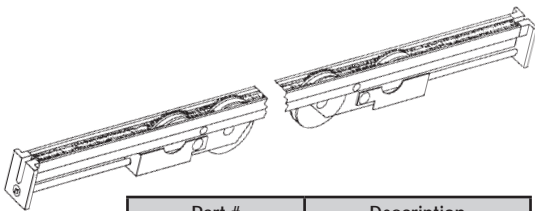

Part #	Description
900-15116	for 34" Glass 38-1/2"
900-15117	for 46" Glass 50"

Assembly has Four 1-1/8" Steel Adjustable Rollers-

## Nylon Wheels

In Order by Wheel Diameter

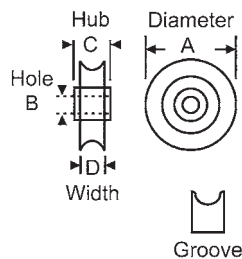

Part #	A	B	C	D
11-129	5/8"	5/32"	3/16"	3/16"

Nylon with Axle



Part #	A	B	C	D
11-115	5/8"	3/16"	1/4"	3/16"

Nylon

# Patio Door Hardware

## Nylon Wheels

In Order by Wheel Diameter

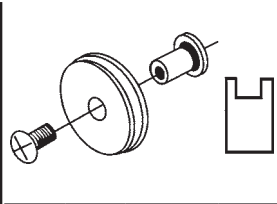
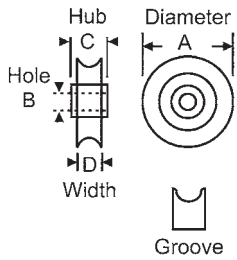

Part #	A	B	C	D
11-112	1-5/64"	1/4"	1/4"	15/64"

Nylon with Post and Screw  
Air Control

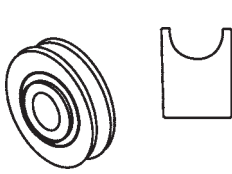

Part #	A	B	C	D
11-120	1-1/4"	1/4"	11/32"	5/16"

Nylon with Ball Bearing Steel Hub

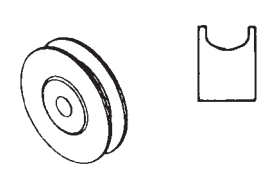

Part #	A	B	C	D
11-122	1-31/64"	1/4"	11/32"	19/64"

Nylon with Ball Bearing Steel Hub

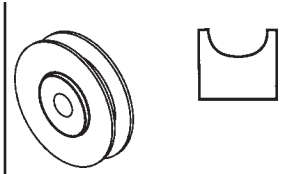

Part #	A	B	C	D
11-110	1-11/16"	1/4"	29/64"	13/32"

Nylon with Steel Ball Bearing Hub

## Steel Wheels

In Order by Wheel Diameter

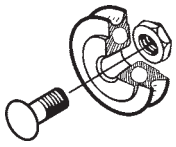

Part #	A	B	C	D
11-130	1"	1/4"	3/8"	5/16"

Steel with Steel Ball Bearing Hub,  
Nut & Bolt.  
11-130X for Roller Only

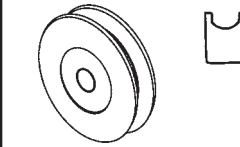

Part #	A	B	C	D
900-9576	1-1/8"	1/4"	3/8"	5/16"

Steel with Ball Bearing Hub

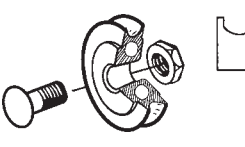

Part #	A	B	C	D
11-116	1-1/4"	1/4"	11/32"	5/16"

Steel with Steel Ball Bearing Hub  
Nut & Bolt.  
11-116X for Roller Only



Part #	A	B	C	D
11-139	1-1/4"	1/4"	51/64"	5/16"

Steel with Steel Ball Bearing Hub  
Acorn

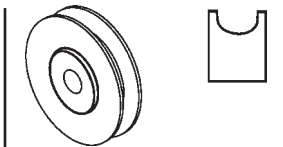

Part #	A	B	C	D
11-111	1-15/32"	1/4"	11/32"	5/16"

Steel with Steel Ball Bearing Hub

Part #	A	B	C	D
11-111SS	1-15/32"	1/4"	11/32"	5/16"

All Stainless Steel

## Sliding Glass & Screen Door Keepers

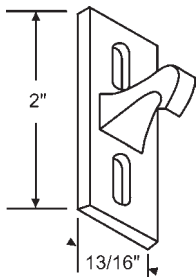

**12-251**  
Chrome Plated  
Miller

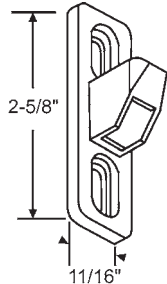

Part #	Finish
12-214	Chrome
12-214B	Black

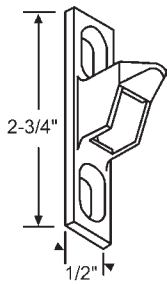

**12-211**  
Chrome Plated  
Narrow

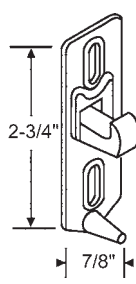

**12-205**  
Chrome Plated  
Crossly

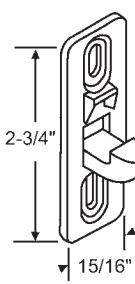

**12-216**

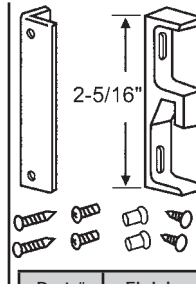

Part #	Finish
12-237	Aluminum
12-237B	Black

Universal Strike Kit

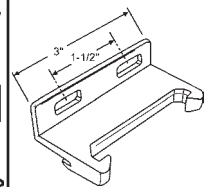

**900-69**  
Mill Finish  
Yale-Ogdon

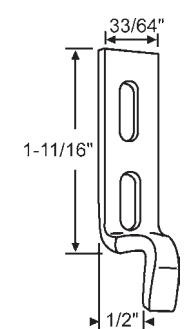

**12-304**  
Metal  
Wright Products

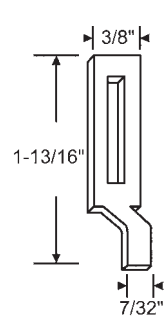

**12-206**  
Metal  
Rite Screen

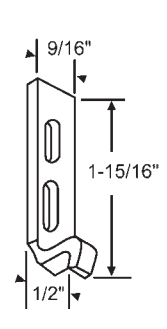

**12-248**  
Metal  
Acorn

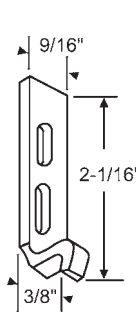

**12-240**  
Steel  
Wright Products

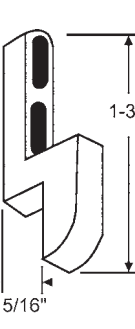

**12-212**  
Mill Finish  
Rite Screen

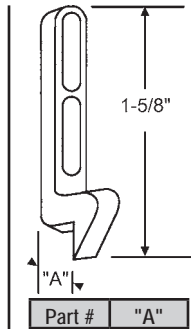

Part #	"A"
12-207	11/16"
12-226	3/16"
12-255	5/16"
12-230	15/32"

Mill Finish

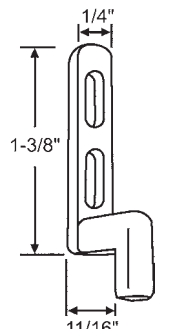

**12-287**  
Bayform

## Flush Mount Handles For Patio Doors

In Order by Hole Spacing

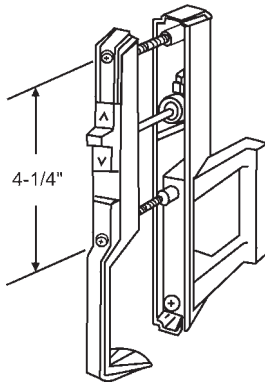

**13-275**  
Black  
Ariel- Peachtree

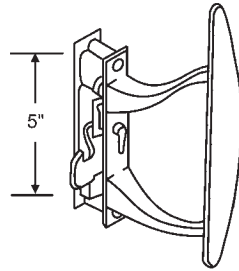

Part #	Hand	Finish
13-171	Shown	Aluminum
13-172	Opposite	Aluminum

Tucker

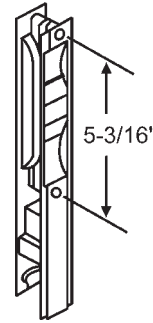

**13-177**  
Daryl

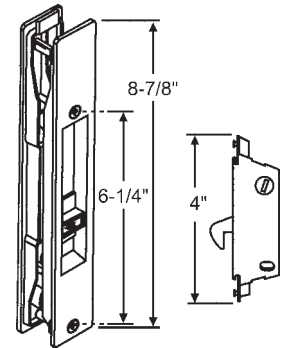

**13-391**  
Adams Rite

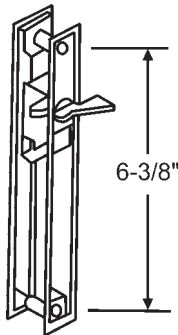

**13-175**  
Less Key Lock  
Miller

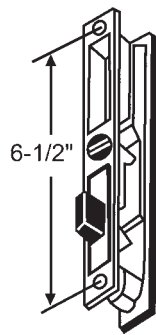

**13-100**  
Handle Set Less Key Lock  
Chrome Plated  
For Optional Pull Handle Use 13-108  
Crossly

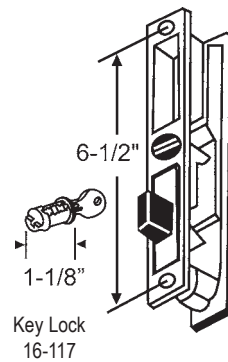

**13-107**  
Handle Set with Key Lock  
Chrome Plated  
For Optional Pull Handle Use 13-108  
Crossly

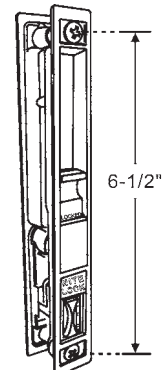

**900-7559**  
Black  
No Longer Available.  
Use: 13-140B or 13-192B

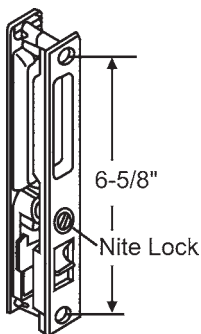

### Fit-All Flush Mount Handle Set with Nite Lock

Handle Set without Key Cylinder

Part #	Finish
13-140	Chrome
13-140B	Black
13-140W	White

Handle Set with Key Cylinder

Part #	Finish
13-140K	Chrome
13-140BK	Black
13-140WK	White

Both Handle Sets Include: Each of 5 Cam Sizes (S,C,P,X,K), 2 Screws and Keeper

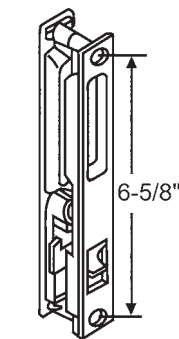

### Fit-All Flush Mount Handle Set without Nite Lock

Handle Set without Key Cylinder

Part #	Finish
13-192	Chrome
13-192B	Black
13-192W	White

Handle Set with Key Cylinder

Part #	Finish
13-192K	Chrome
13-192BK	Black
13-192WK	White

Both Handle Sets Include: Each of 5 Cam Sizes (S,C,P,X,K), 2 Screws and Keeper

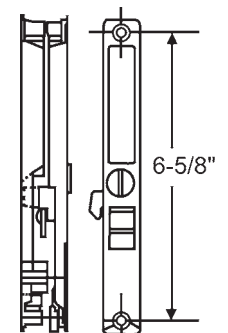
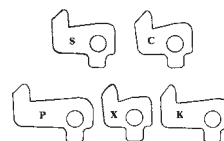

Part #	Finish
13-292	Chrome Plated
13-292W	White

With Nite Lock, "C" Cam and Keeper

# Patio Door Hardware

## Flush Mount Handles For Patio Doors

## Handles For Patio Doors

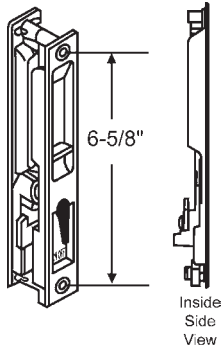

Inside  
Side  
View

Part #	Finish
900-21019	Black
900-21019C	Chrome
900-21019W	White

With Nite Lock, "S" Cam  
and Keeper

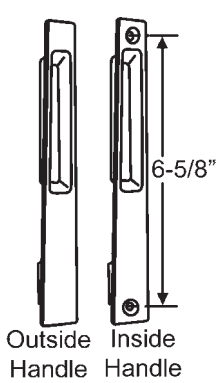

**13-311**  
Flush mount dummy set. Chrome

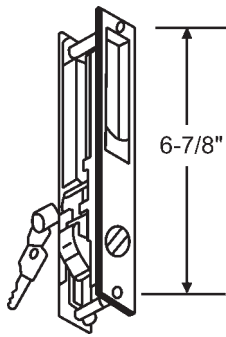

Part #	Description
13-178	w/Key Lock
13-178X	No Key Lock

Daryl

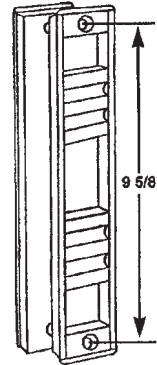

Part #	Finish
900-17543	Black
900-17543W	White

TM Products

In Order by Hole  
Spacing

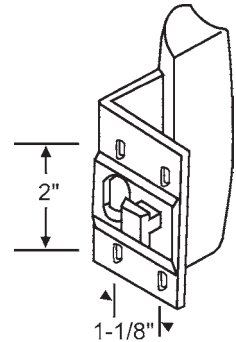

**13-191**  
Used with Lock Bar 16-188 and  
16-230  
Capitol

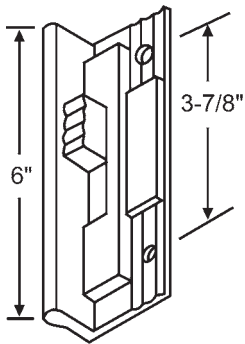

**900-49**  
Interior Handle  
Aluminum Finish

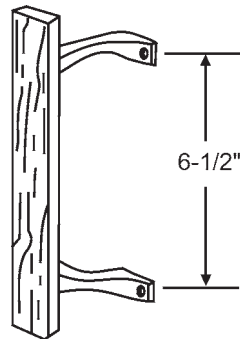

Part #	Finish
13-259	Chrome with Wood Handle
13-259B	Black with Wood Handle

Solid One Piece Bracket

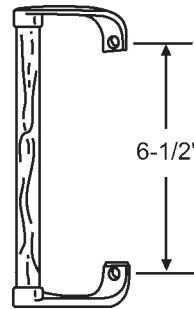

**13-108**  
Wood with Chrome Brackets  
Crossly

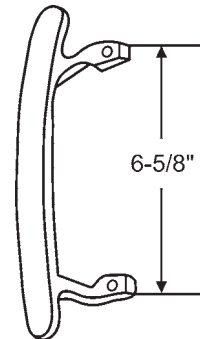

Part #	Finish
13-105	Chrome
13-105B	Black
13-105W	White

Die Cast

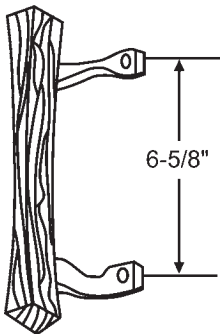

Part #	Finish
13-109	Chrome with Wood Handle
13-109B	Black with Wood Handle
13-109W	White with Wood Handle

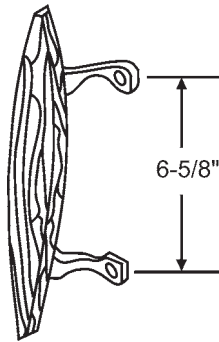

Part #	Finish
13-115	Chrome with Wood Handle
13-115B	Black with Wood Handle

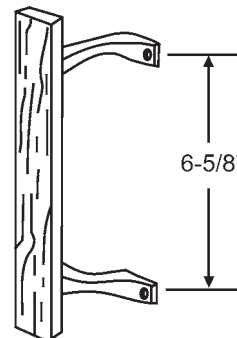

Part #	Finish
13-232	Chrome with Wood Handle
13-232B	Black with Wood Handle

Heavy Duty Brackets  
Capitol

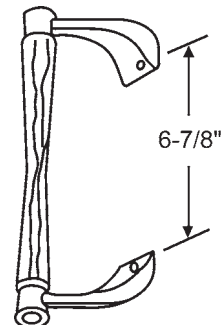

**900-9**  
Walnut Handle with Brackets  
Daryl

## Handles For Patio Doors

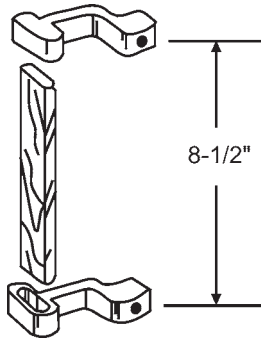

**13-190B**  
Wood with Black Brackets  
Use with 13-100 and 13-107  
Capitol

## Handle Brackets

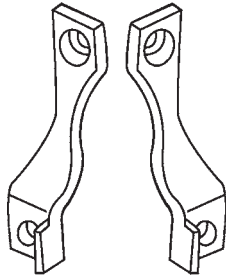

Part #	Finish
16-125	Black
16-123	Chrome

Handle Brackets Sold in Pairs  
Used with 13-109, 13-115

## Handle Sets For Patio Doors

In Order by Style and Hole Spacing

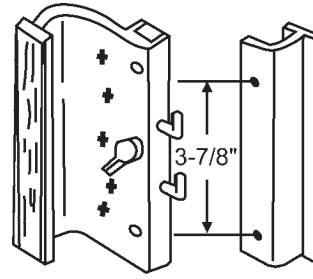

Part #	Finish
13-153	Aluminum
13-153B	Black

Ador Hi-Lite

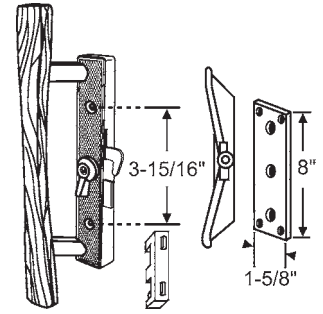

Handle Set with Plate

Part #	Finish
13-112	Aluminum with Wood Handle

Handle Set without Plate

Part #	Finish
13-112X	Aluminum with Wood Handle

Handle Set with Plate and 16-126 Key

Part #	Finish
13-113	Aluminum with Wood Handle

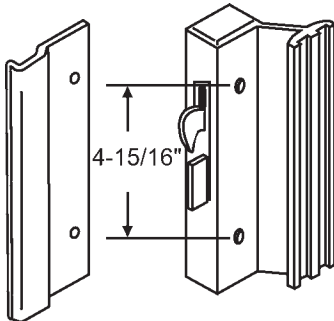

Part #	Finish
13-152	Aluminum
13-152B	Black

Includes Fit-All Keeper Assy., Screws and  
Black Outside Pull

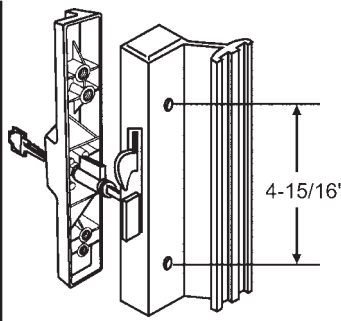

Part #	Finish
13-152K	Aluminum
13-152BK	Black

Includes Fit-All Keeper Assy., Screws and  
Black Outside Pull with Key Cylinder

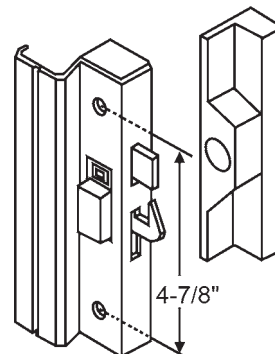

**13-255**  
Black

Peachtree/Citation

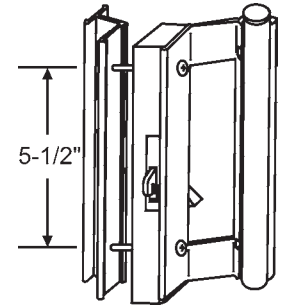

**13-160**

New Style  
Aluminum Finish  
Peachtree

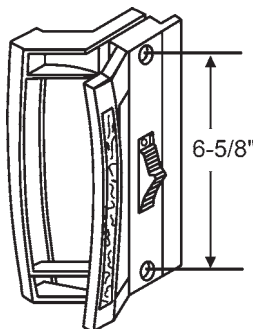

**900-16317**  
Black. Includes Keeper and Screws  
Norandex

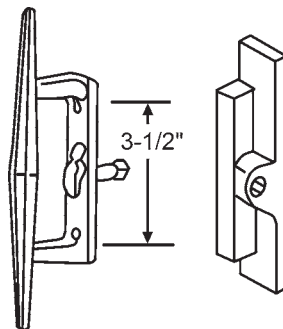

**13-106**

Original Acorn Metal Handle Set  
Base Plate Only: 900-8200  
Acorn

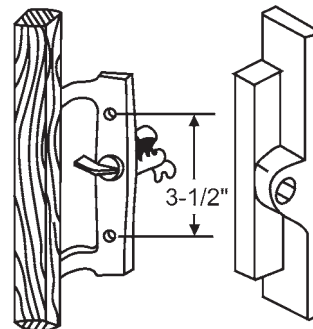

Handle Set without Key Cylinder

Part #	Finish
13-106X	Black

Handle Set with Key Cylinder

Part #	Finish
13-106KX	Black

Acorn Replacement

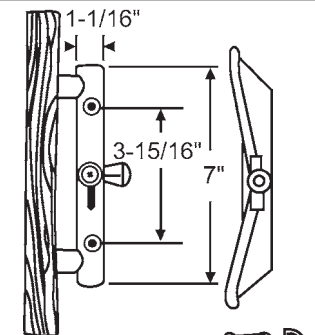

**16-126**

Key Lock

Handle Set with Key Lock

Part #	Finish
13-101	Aluminum w/Brown Handle

Handle Set without Key Lock

Part #	Finish
13-114	Aluminum w/Brown Handle

# Patio Door Hardware

## Handle Sets For Patio Doors

In Order by Style and Hole Spacing

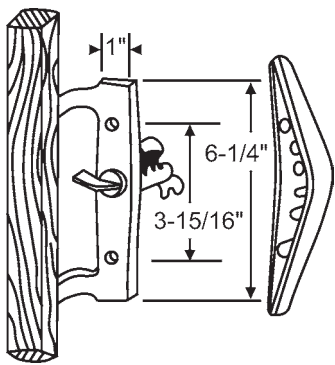

Part #	Finish	Description
13-104	Aluminum	No Key
13-104K	Aluminum	w/Key
13-141	Black	No Key

with 12-240 Keeper

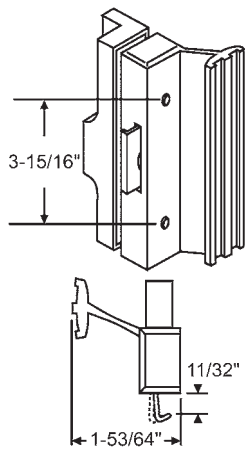

### 900-19556

Aluminum with Black outside pull  
Pennco

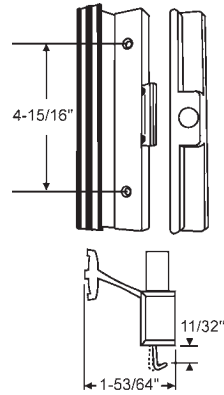

Part #	Handle Finish	Pull Finish
13-195	Black	Black
13-195A	Aluminum	Black
13-195W	White	White

Plastic Outside Pull  
Better-Bilt/Traco

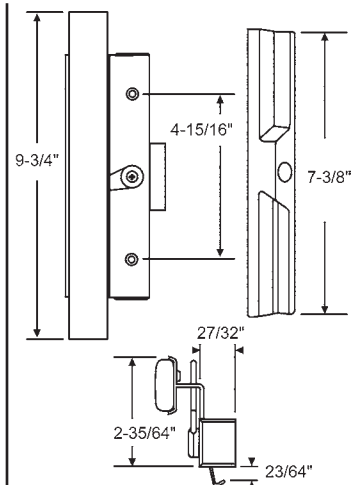

### 13-258

Black Finish. All Metal with Wood Handle  
Rollyson

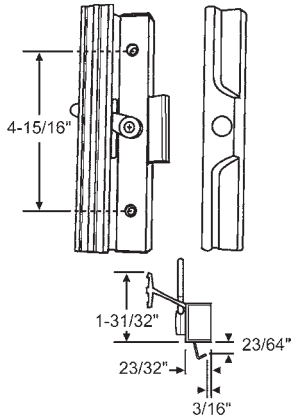

Part #	Finish
13-271	Black
13-271WH	White

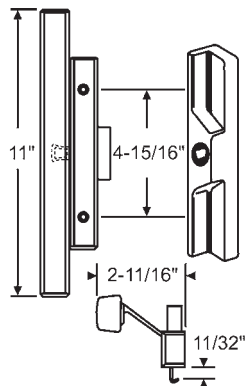

### 900-11414

Black with Wood Handle. Black Outside Pull  
Traco

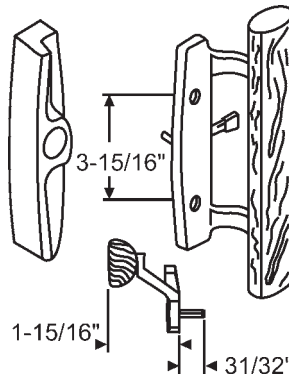

Handle Set without Key Cylinder

Part #	Finish
13-154	Black
13-154W	White
13-154CBZ	Bronze
13-154A	Almond

Handle Set with Key Cylinder

Part #	Finish
13-154K	Black
13-154WK	White

Metal with Wood Handle  
Sash Controls

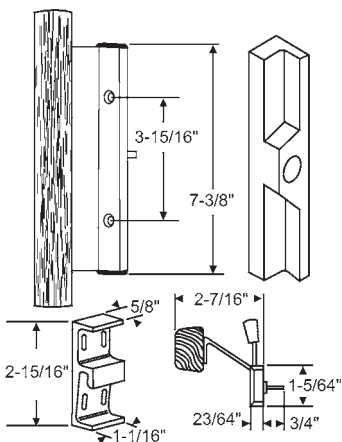

### 13-282BG

Beige. With 11" Solid Oak Bar and Keeper  
Malta

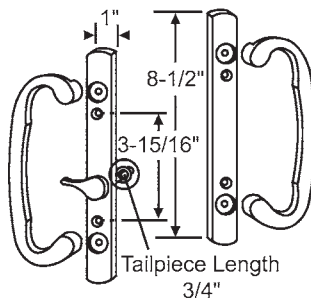

Part #	Finish
13-245BP	Brass Plated
13-245BC	Brushed Chrome
13-245W	White
13-245BZ	Bronze
13-245AB	Antique Brass

Offset Latch. 2265 Stamped on Back of Plate  
Mortise Lock Sold Separately  
Sash Controls

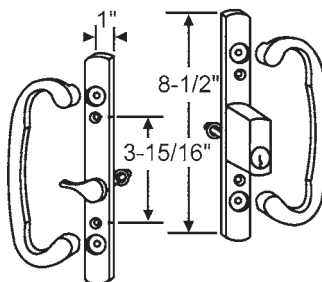

Part #	Finish
13-245WK	White
13-245BPK	Brass Plated
13-245BZK	Bronze
13-245ABK	Antique Brass

Offset Latch. 2265 Stamped on Back of Plate  
Mortise Lock Sold Separately  
Sash Controls

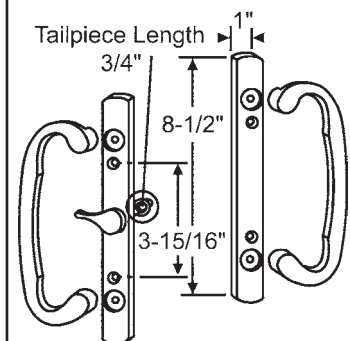

### 13-291

White. No Key. Center Latch  
2265 Stamped on Back of Plate  
Mortise Lock Sold Separately  
Sash Controls

## Handle Sets For Patio Doors

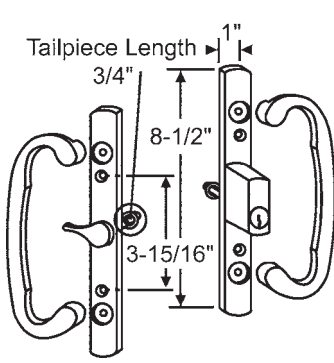

### 13-291K

White. With Key. Center Latch  
2265 Stamped on Back of Plate  
Mortise Lock Sold Separately  
Sash Controls

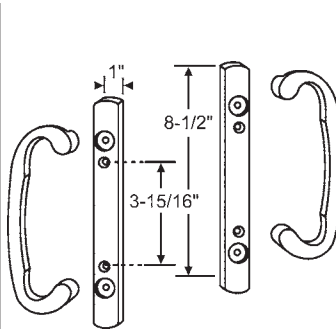

Part #	Finish
13-284DAB	Zinc-Antique Brass
13-284DBC	Zinc-Brushed Chrome

Dummy Set  
Mortise Lock Sold Separately  
Sash Controls

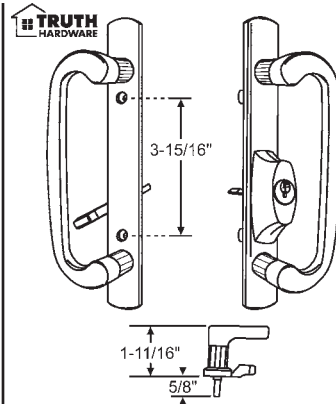

Part #	Description
13-295-10K	Offset Latch w/Key Lock
13-295-10D	Dummy Set

Black

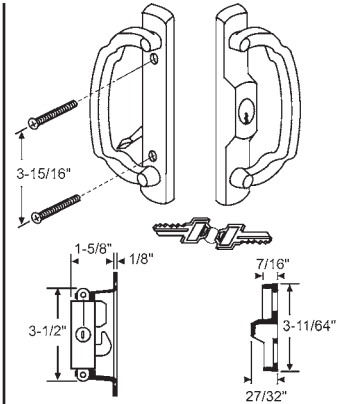

### 13-296PB

Solid Brass. Polished Brass finish with key  
combination mortise lock, keeper and all  
necessary screws.  
Peachtree/Prado

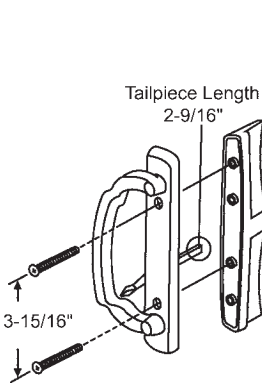

### 13-280

White  
Acorn

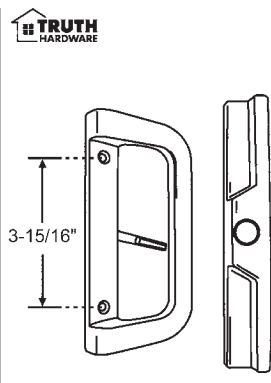

### 13-394-3

White

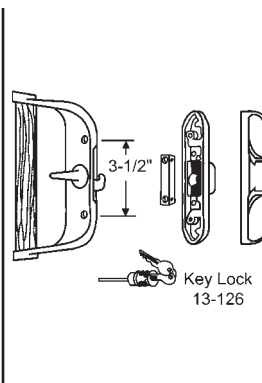

Part #	Description
13-188K	w/Key Lock
13-188	No Key Lock

Gray

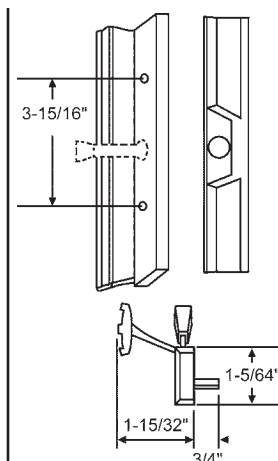

### 900-21409W

White

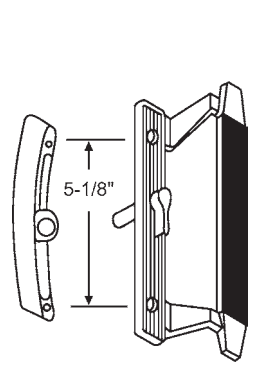

### 13-173

Gray Finish  
13-194 Outside Pull Only  
Howard

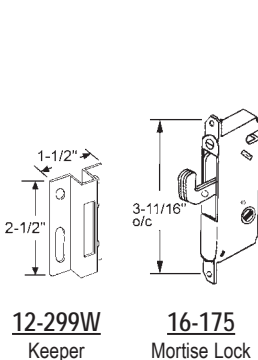
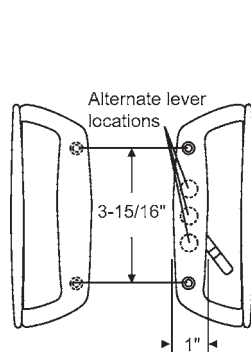

12-299W  
Keeper

16-175  
Mortise Lock

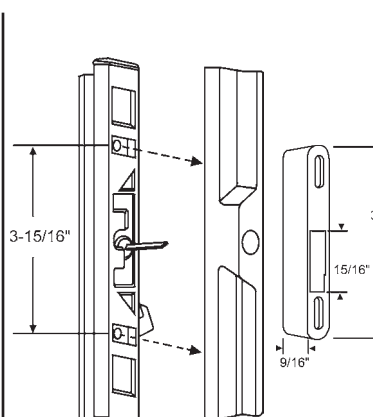

### 900-21630

White  
American Weatherseal

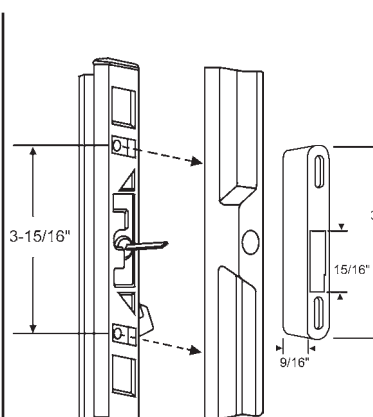

### 900-13021

Handle Assembly with Keeper  
Uses 900-9169 Mortise Lock  
Pennco

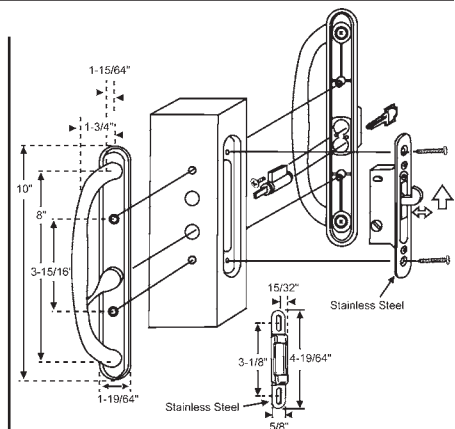

Part #	Finish
13-341BKA	Black
13-341WKA	White

Offset Latch with Key, Stainless Steel Mortise Lock  
and Keeper  
Amesbury

## Sliding Door Trim Sets



*Used by Marvin Integrity, Comfort Line,  
Therma Tru, Kolbe & Kolbe*

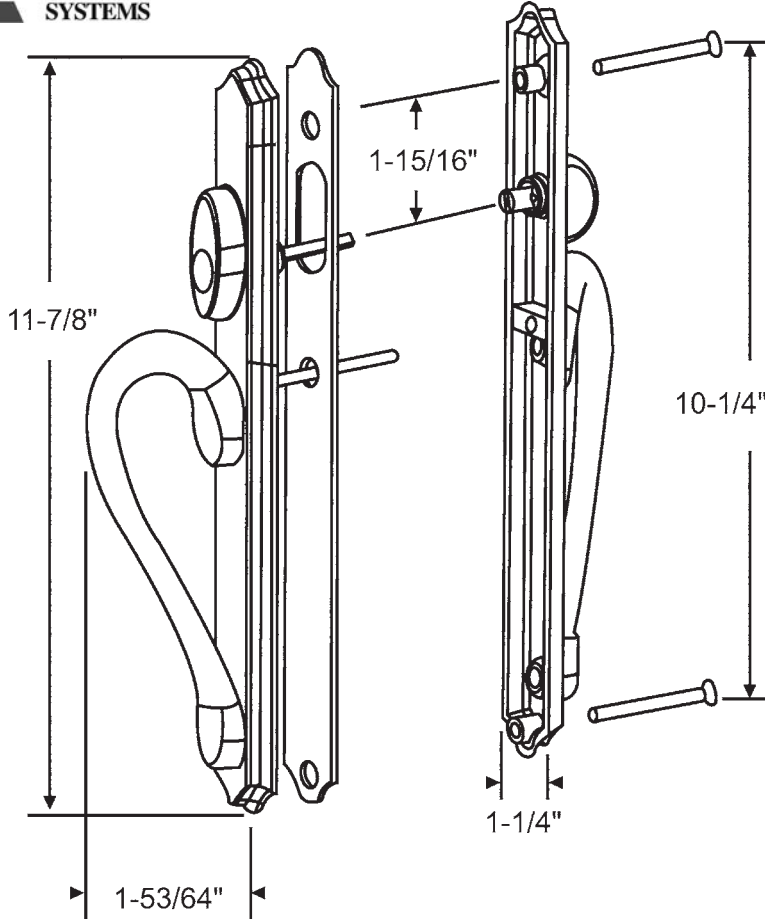

### Zinc Die Cast Sliding Door Trim Sets

Active - Thumb Turn w/Key

For 1.7" Door	
Part #	Finish
13-346AD	Almond
13-346B	Black
13-346W	White

Active(Shown) - Thumb Turn No Key

For 1.7" Door	
Part #	Finish
13-347AD	Almond
13-347B	Black
13-347W	White

Passive - No Thumb Turn, No Key

For 1.7" Door	
Part #	Finish
13-348AD	Almond
13-348B	Black
13-348W	White

### Solid Brass Sliding Door Trim Sets

Active - Thumb Turn w/Key

For 1.7" Door	
Part #	Finish
13-342AB	Antique Brass
13-342BC	Brushed Chrome
13-342BRS	PVD Brass
13-342CH	Chrome

For 2.0" Door

Part #	Finish
13-345AB	Antique Brass
13-345B	Black
13-345BC	Brushed Chrome
13-345BRS	PVD Brass
13-345CH	Chrome
13-345ORBZ	Oil Rubbed Bronze
13-345P	Pewter
13-345PB	Polished Brass
13-345SCH	Satin Chrome
13-345SNK	PVD Satin Nickel

Active - Thumb Turn No Key

For 1.7" Door	
Part #	Finish
13-343AB	Antique Brass
13-343PB	Polished Brass
13-343ORBZ	Oil Rubbed Bronze
13-343CH	Chrome
13-343BC	Brushed Chrome
13-343SCH	Satin Chrome
13-343P	Pewter
13-343B	Black
13-343BRS	PVD Brass
13-343SNK	PVD Satin Nickel

Passive - No Thumb Turn, No Key

For 1.7" Door	
Part #	Finish
13-344PB	Polished Brass
13-344ORBZ	Oil Rubbed Bronze
13-344CH	Chrome
13-344BC	Brushed Chrome
13-344SCH	Satin Chrome
13-344P	Pewter
13-344AB	Antique Brass
13-344AD	Almond
13-344B	Black
13-344W	White
13-344BRS	PVD Brass
13-344SNK	PVD Satin Nickel

## Sliding Door Trim Sets



inspirations

*Solid Brass aesthetically pleasing trim sets and high corrosion resistance*

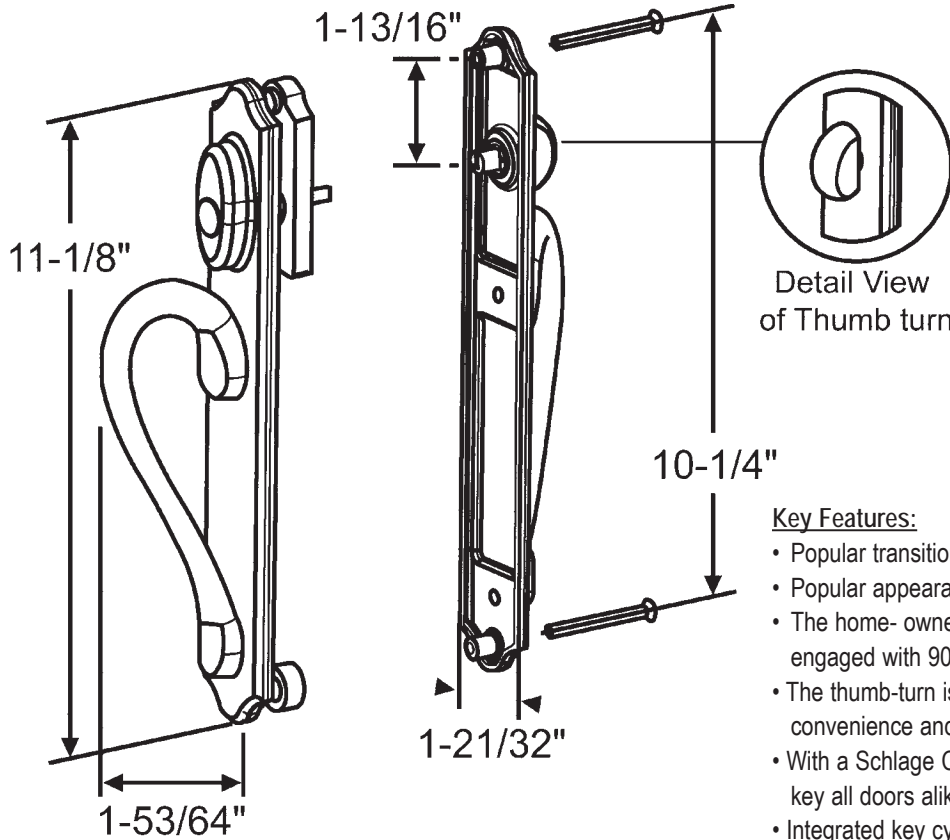

**Key Features:**

- Popular transitional style that is ergonomically friendly
- Popular appearance with first- class finishes
- The home- owner can visually verify that lock is engaged with 90-degree thumb-turn rotation
- The thumb-turn is located above the handle for convenience and ease of use
- With a Schlage C-keyway cylinder, homeowners can key all doors alike
- Integrated key cylinder housing prevents air and water infiltration and offers superior security
- Gasket behind escutcheon plate reduces air infiltration from the exterior
- Weep hole on exterior escutcheon plate prevents water collection

**Active - Thumb Turn w/Key**

Part #	Finish
13-335ORBZK	Oil Rubbed Bronze
13-335BCHK	Bright Chrome
13-335SCHK	Satin Chrome
13-335PK	Pewter
13-335BK	Black
13-335BGK	Beige
13-335WK	White
13-335ABK	Antique Brass
13-335PBK	Polished Brass
13-335BRK	PVD Brass
13-335SNKK	PVD Satin Nickel

**Active - Thumb Turn No Key**

Part #	Finish
13-335ORBZ	Oil Rubbed Bronze
13-335BCH	Bright Chrome
13-335SCH	Satin Chrome
13-335P	Pewter
13-335B	Black
13-335BG	Beige
13-335W	White
13-335AB	Antique Brass
13-335PB	Polished Brass
13-335BRS	PVD Brass
13-335SNK	PVD Satin Nickel

**Passive/ Dummy- No Thumb Turn, No Key**

Part #	Finish
13-335ORBZD	Oil Rubbed Bronze
13-335BCHD	Bright Chrome
13-335SCHD	Satin Chrome
13-335PD	Pewter
13-335BD	Black
13-335BGD	Beige
13-335WD	White
13-335ABD	Antique Brass
13-335PBD	Polished Brass
13-335BRSD	PVD Brass
13-335SNKD	PVD Satin Nickel

# Patio Door Hardware

## Handle Sets For Patio Doors

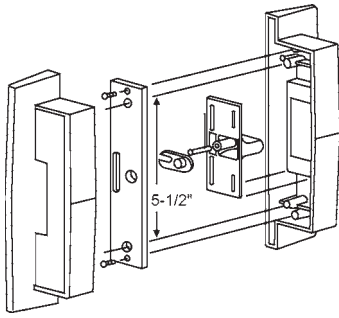

### 900-21292

Replacement Black Finish. Used with  
16-171 & 16-171SS Mortise Lock  
Acadia

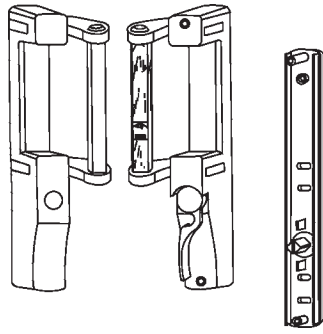

Part #	Finish	Handle
13-308PB	Polished Brass	Brass
13-307AB	Antique Brass	Wood

Mortise Lock (16-363 and  
Keeper (900-17355) Sold Separately  
Hurd/Chatel

## Outside Handle Pulls For Patio Doors

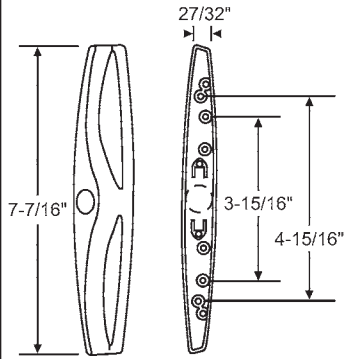

Part #	Finish
13-427B	Black
13-427W	White

Die Cast. No Cylinder Hole

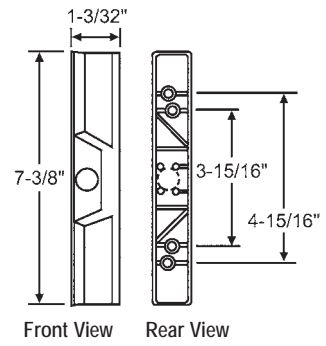

Part #	Description
900-8281	Black Plastic
900-8281M	Black Metal
900-8281MW	White Metal

Without Cylinder hole

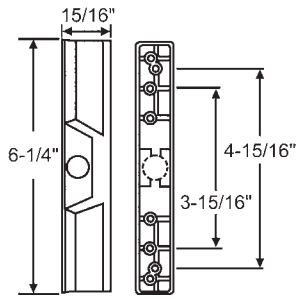

Front View Rear View

### 900-17370

Black  
Without Cylinder Hole

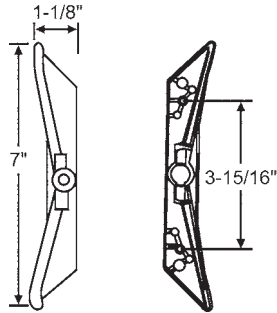

Front View Rear View

### 900-48

Aluminum  
Die Cast

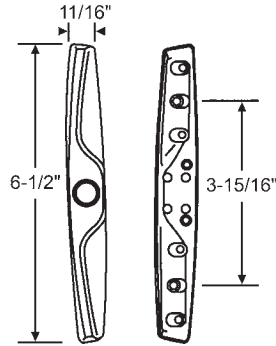

Front View Rear View

Part #	Finish
13-142	Aluminum

Die Cast

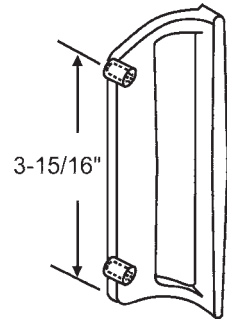

### 13-147

Flush Mount Pull. Aluminum

## Handles For Patio Screen Doors

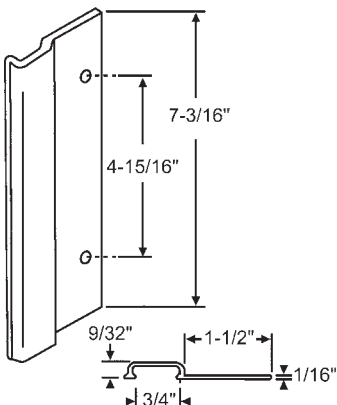

Part #	Finish
16-198	Aluminum
16-199	Black

Outside Pull

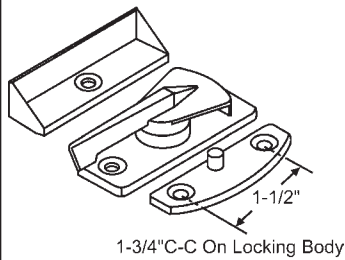

### 14-97

Howard

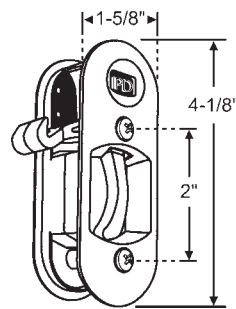

### 14-116

Almond  
Peachtree

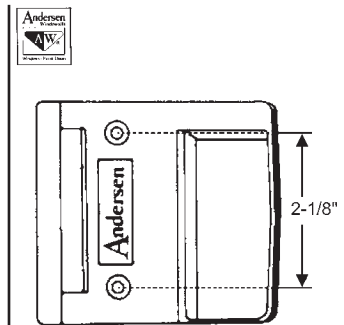

Part #	Finish
750-1997194	Stone
750-1997306	White

## Handles For Patio Screen Doors

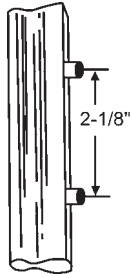

Part #	Finish
750-1997195	Stone
750-1997307	White

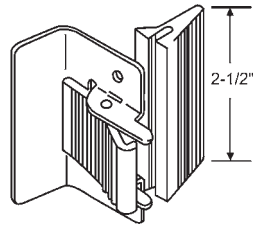

**14-72**

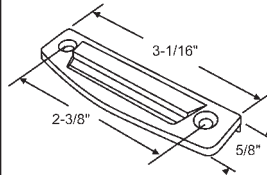

Part #	Finish
16-485B	Black
16-485W	White

Nylon Keeper

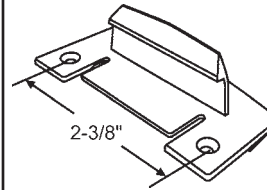

Part #	Finish
16-484B	Black
16-484W	White

Nylon Outside Handle

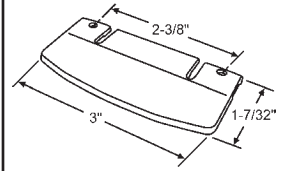

Part #	Finish
16-486B	Black
16-486W	White

Nylon Inside Handle

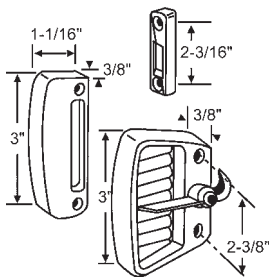

**14-75B**

Handle Assembly (3 pieces)  
Black  
Traco

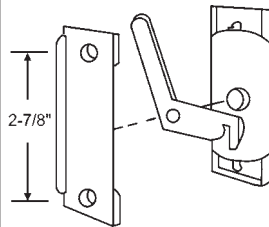

**14-61**

Handle Assembly with Latch  
Walters

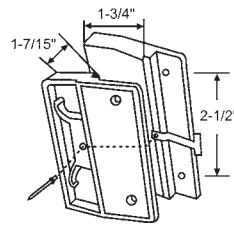

**900-17710**

Spring Loaded Black Plastic  
Rite Screen/Metal  
Industries

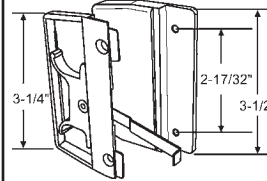

**14-52**

Black With Keeper and Screws  
Rite Screen

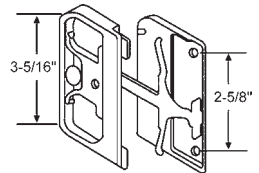

**14-64**

Metal Industries

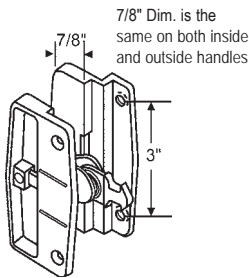

**14-95**

Handle Assembly  
Columbia

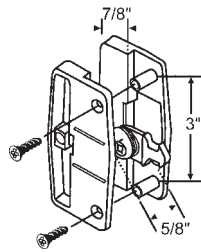

**14-94**

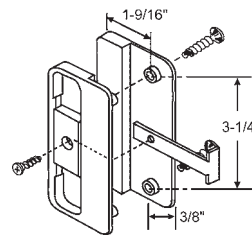

**14-96**

Handle Set. Black  
Jim Walters

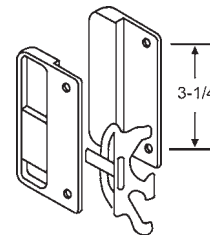

**14-63**

Handle Assembly  
Jim Walters

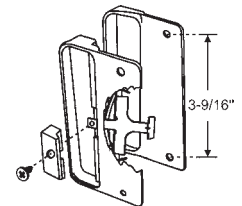

**14-62**

Acorn

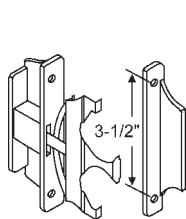

**14-103**

Black

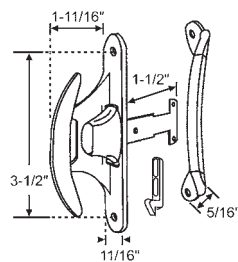

**14-155A**

Includes Keeper  
Bayform

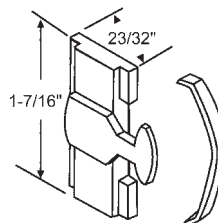

**900-10783**

Black with Spring  
Crossly

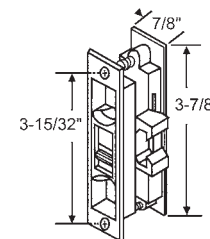

**900-11214**

Patio Screen Latch Assembly  
Includes 12-308 Keeper  
Peachtree

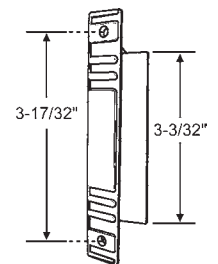

Part #	Finish
14-147W	White
14-147DT	Desert Tan

Inside Screen Pull Handle

# Patio Door Hardware

## Handles For Patio Screen Doors

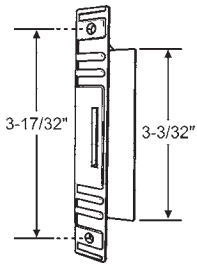

**14-151BR**  
Inside Screen Pull Handle. Brown

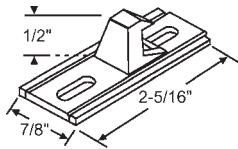

**12-308**  
Black Plastic  
Peachtree

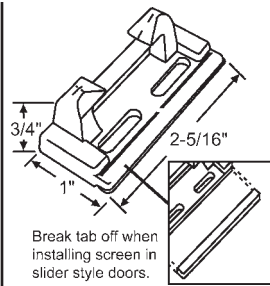

Break tab off when installing screen in slider style doors.

**900-21646**  
Beige  
Peachtree

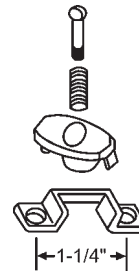

**14-51**  
Latch Assembly  
Acorn

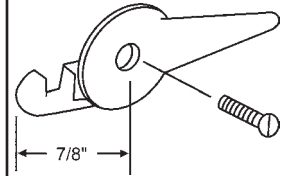

**14-54S**  
Latch Assembly with Spring

## Patio Door Screw Hole Covers

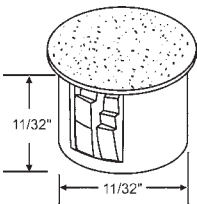

**16-335**  
Large Cover  
Black

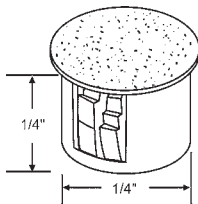

**16-336**  
Small Cover  
Black

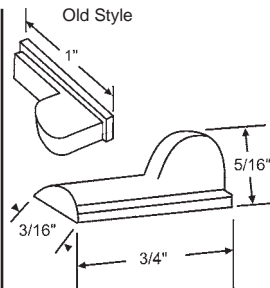

**900-6902**  
Crossly/Lumidor

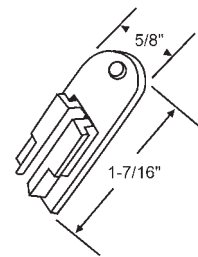

**15-63**

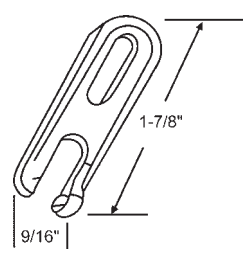

**15-55**  
Screen Guide  
Crossly

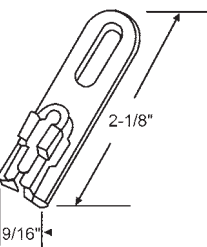

**15-54**

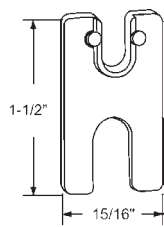

**900-10074**  
Nylon  
Lawson/Crown

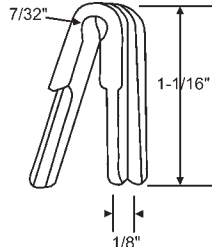

**900-71**  
Miller

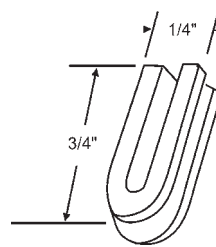

**15-94**  
Daryl

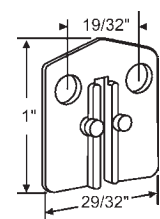

**900-10073**  
Nylon  
Lawson/Crown

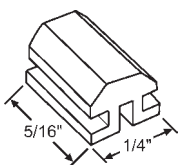

**52-846**  
White  
Pan Am/Binnings

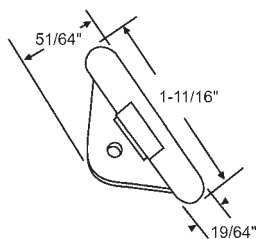

**15-66**  
Nylon  
Alcan

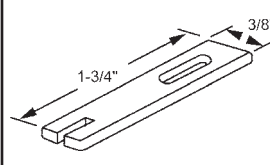

**15-65**  
Nylon  
Bellview

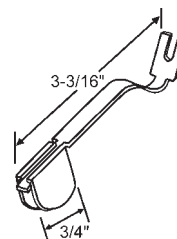

**15-57**  
Nylon  
Acorn

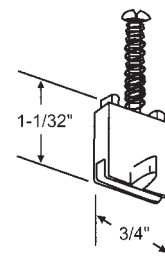

**900-84**  
Bottom Guide  
Tucker

## Screen Door Guides

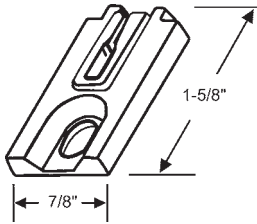

**15-52**  
Top Guide  
Daryl

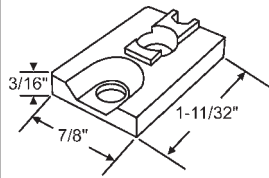

**900-78**  
Bottom Guide  
Tucker

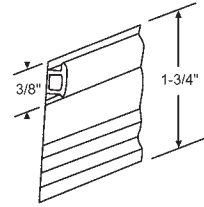

Part #	Length
16-243	50 ft.
16-243M	250 ft.

Can Be Torn Away in 3/16" Increments. Black

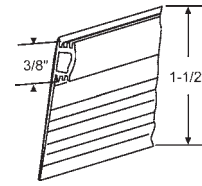

Part #	Length
16-244	50 ft.
16-244M	250 ft.

Can Be Torn Away in 1/8" Increments

## Patio Door Bumper

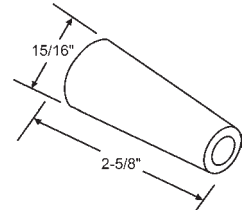

Part #	Finish
16-227B	Black
16-227W	White

Rubber

## Anti-Rattle Guides

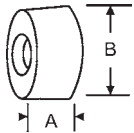

Part #	A	B	Finish
16-105	3/8"	15/16"	Gray
16-107	7/32"	3/4"	Clear

Rubber

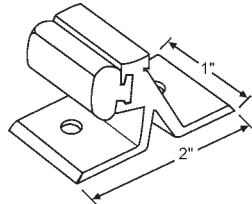

**16-579**  
Aluminum  
Miller

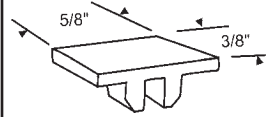

Part #	Finish	Description
15-88	Black	for Steel Doors
15-89	White	for Aluminum Doors

Anti-Rattle Guides

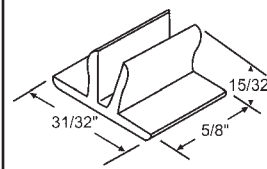

**900-7228**  
Nylon

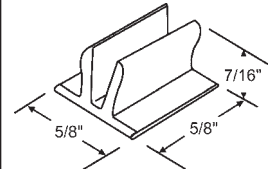

**900-7225**  
Nylon

## Security Hardware & Patio Door Locks



### Charley-BAR

Safety Lock



Makes Sliding Glass Doors Jimmy-Proof!

**NEW STEEL SAFETY KEY LOCK**



**16-108H**

Charley Bar Hardware Pack includes plastic saddle, rubber cap, four #8 1/2" sheet metal screws and metal angle bracket

Mailing TUBE - 50 per carton sold in carton qty only

Part #	Size	Finish
16-108T	48"	Mill
16-108TB	48"	Bronze
16-108TW	48"	White

Carded - 10 per carton sold in carton qty only

Part #	Size	Finish
16-108C	48"	Mill
16-108CB	48"	Bronze
16-108CW	48"	White

BULK - 25 per carton

Part #	Size	Finish
16-108	48"	Mill
16-108B	48"	Bronze
16-108W	48"	White
16-108-60	60"	Mill

Poly Bagged - 50 per Box

Part #	Size	Finish
16-108P	48"	Mill

- Key hangs neatly out of your way when not in use
- Comes with all necessary hardware and instructions
- Available in three lengths, three finishes and three packages
- Anodized Aluminum construction allows it to be cut to fit any size door
- New security feature: Improved black plastic saddle now takes a key so that the bar cannot be raised from the outside by wires or other devices
- New saddle keeps small children from opening the door from the inside

## Security Lock

### Security Lock

for both sliding glass doors and windows

MADE OF UNBREAKABLE LEXAN

Super Holding Power

Installs Without Tools

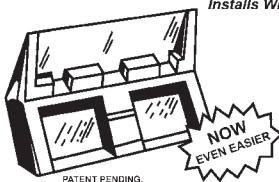

NOW EVEN EASIER

- Installs quickly without special tools.
- 3-M special adhesive bonds to glass like a weld
- Provides positive locking protection.
- Secures both sections firmly.
- Unbreakable GE Lexan.
- Crystal-clear transparency.

**16-192**

Sold in Pairs

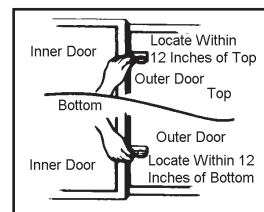

Glass Door Installation:  
Position both Security Locks within 12 inches of top and bottom on outer door flush against inner frame.

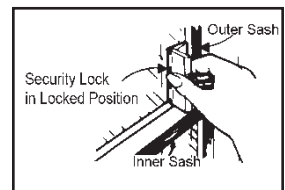

Sash Window Installation:  
Position one Security Lock flush in lower corner of top window.

# Security Hardware

## Security Latch

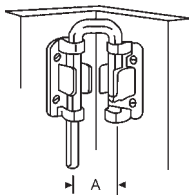

**NARROW FOR EXTRA TIGHT CORNERS**  
Where moldings and jams are narrow and mounting space is limited; 3/4" shackle width.

Part #	Finish	"A"
16-185	Nickel	1-1/8"

- Simple to install
- Very easy to use
- Attractive finishes
- Prevents accidental locking

**STANDARD FOR MOST CORNER APPLICATIONS**  
Where ample mounting space is provided; 1-1/4" shackle width.

Part #	Finish	"A"
16-186	Nickel	1-7/16"

- Can be used on windows too
- Assures snug closure of door
- All mounting hardware included
- Reversible (Works left to right/right to left)
- Latch serves as convenient handle for door

**WIDE FOR OFFSET MOUNTING**  
Where reaches require wider shackle to bridge wide gaps between jams and moldings to wall; 2" shackle width.

Part #	Finish	"A"
16-187	Nickel	2-1/8"

- Makes handy latch for all regular swinging doors
- Mounts anywhere along frame for easy accessibility
- Presently being used by the hospitality industry nationwide
- Sturdily constructed (Handle made from 9/32" steel rod stock)

"A" Dimension equals exact center to center measurement

## Security Hardware & Patio Door Locks

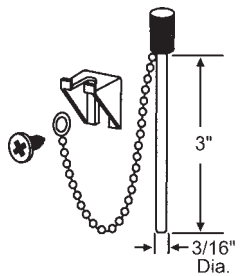

**16-104**  
Burglar Pin/Nite Lock

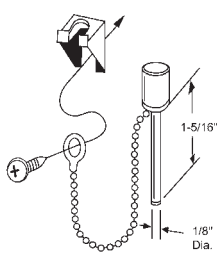

**16-431**  
Burglar Pin/Nite Lock  
Aluminum Finish

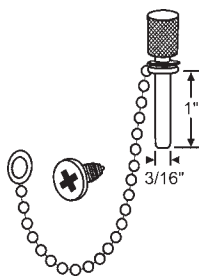

**900-1099**  
Travel Lock

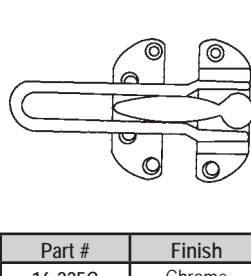

Part #	Finish
16-225C	Chrome
16-225PB	Brass

Door Guard

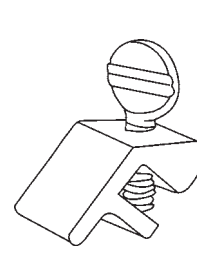

**50-682**

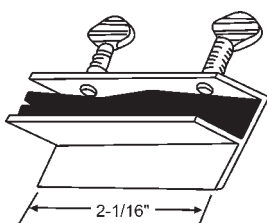

**50-636**

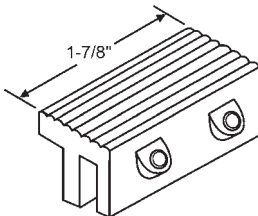

Part #	Finish
900-17508	Black
900-17508A	Aluminum

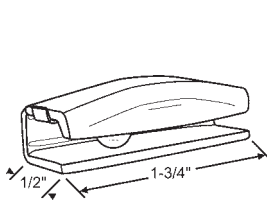

**900-10574**  
Snap-on Vent Lock

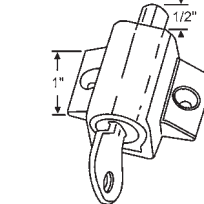

Part #	Finish
900-9718W	White
900-9718	Black

Heavy Duty Die Cast.  
1-1/4" Hole Center

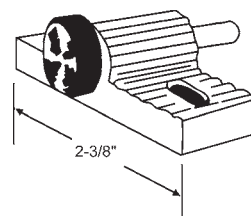

Part #	Finish
16-177	Aluminum
16-177B	Black

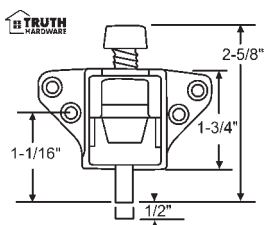

Part #	Finish
16-209-1	Bronze
16-209-3	White

Secondary Patio Lock

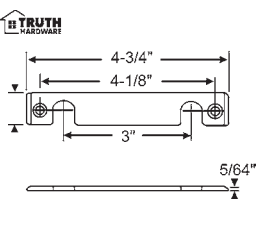

Part #	Finish
12-264-1	Bronze
12-264-3	White

Wingless Patio Lock

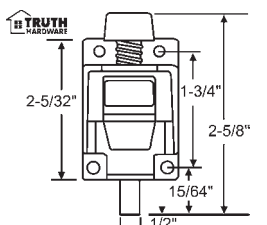

Part #	Finish
16-211-1	Bronze
16-211-3	White

Wingless Patio Lock

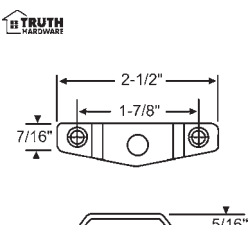

Part #	Finish
12-265-1	Bronze
12-265-3	White

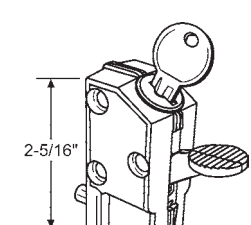

**16-682**  
Mill Finish w/2 Keys  
Pin Length 3/4"

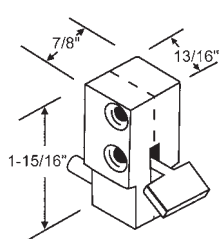

**900-8734**  
Aluminum

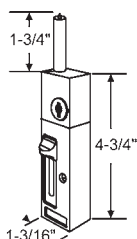

**16-687**  
Security Lock. Aluminum

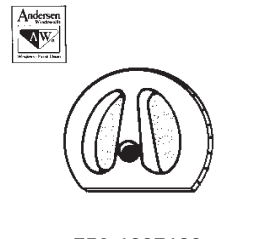

**750-1997192**  
Two Panel Screen Door Lock  
Stone

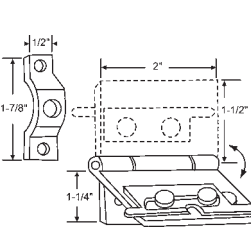

**16-406**  
Aluminum Flip Lock

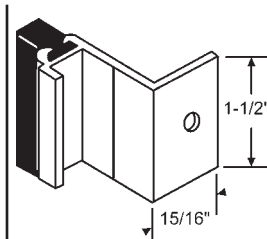

**16-183**  
Fixed Panel Clip

## Key Cylinders

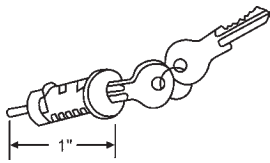

**16-100**  
Key Cylinder Lock

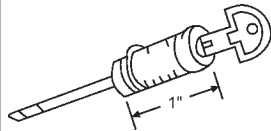

**16-126**  
Key Cylinder

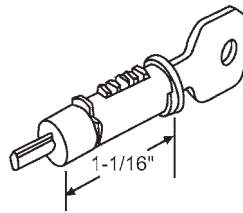

**16-189**  
Key Cylinder

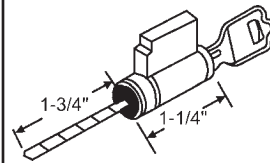

**16-133**  
Key Cylinder Lock

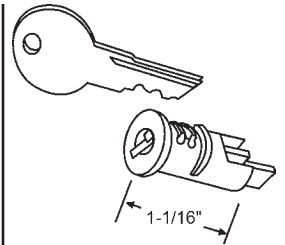

**16-103**  
Key Cylinder

## Mortise Locks

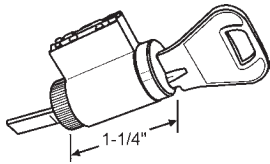

**900-11179**  
Key Cam  
Peachtree

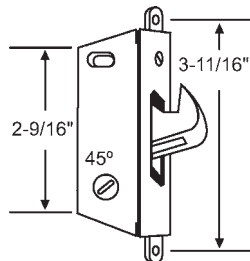

**16-170**  
Square Face

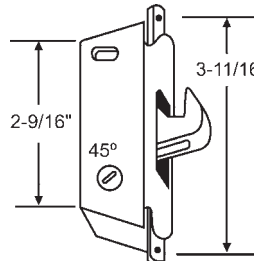

**16-171**  
Round Face

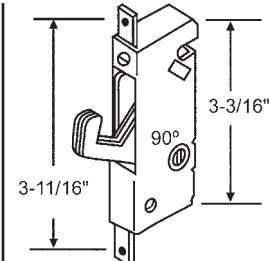

**16-173**  
Square Face

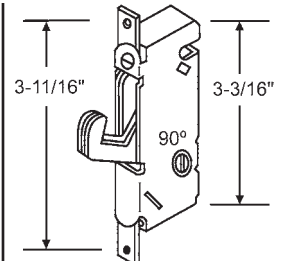

**16-174**  
Round Face

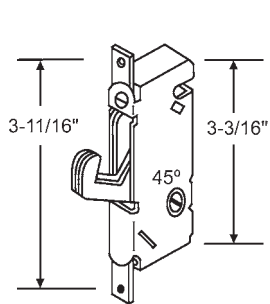

**16-175**  
Round Face

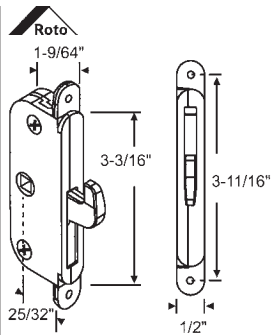

**16-490**  
Single Point Slider Lock

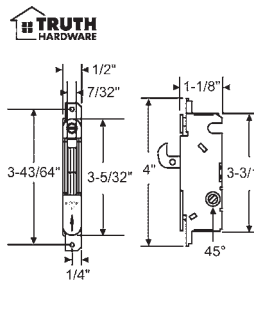

Part #	Description
16-397SS	Stainless Steel
16-397	Clear Chromate

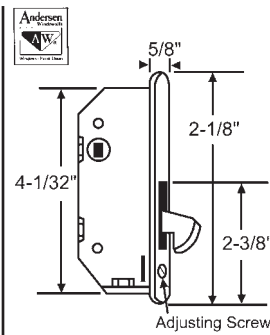

**750-1997156**

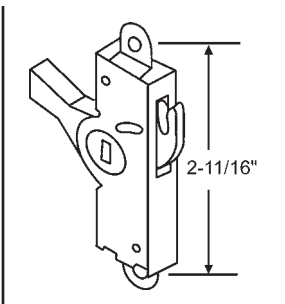

**16-142**  
Used for Surface Mounted  
Patio Door Handle

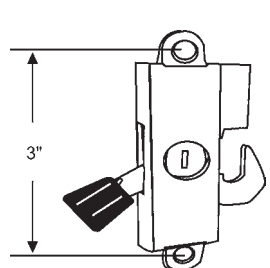

**900-7305**  
Flush Button. Front Surface  
Mounted Steel Hook  
Peachtree

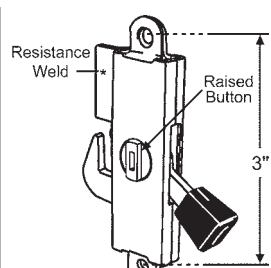

**16-673**  
Raised Button. Front Surface  
Mounted Steel Hook  
Peachtree

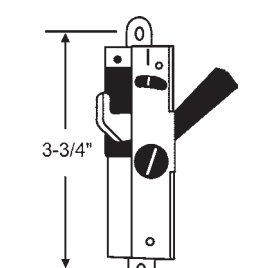

**16-176**  
Used for Surface Mounted  
Patio Door Handle

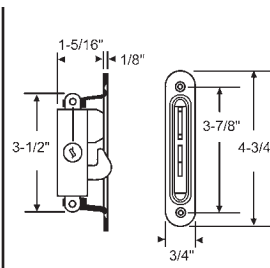

**900-9169**  
Diagonal Hub. Aluminum Finish

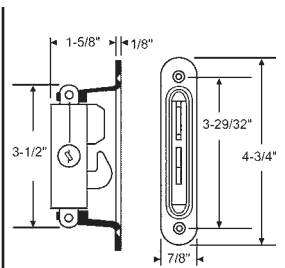

**900-18867**  
Diagonal Hub. Aluminum Finish  
Use: 900-14560 for Keeper  
Traco

# Patio Door Hardware

## Mortise Locks

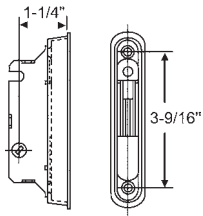

**16-443**  
Mortise Lock and Plate

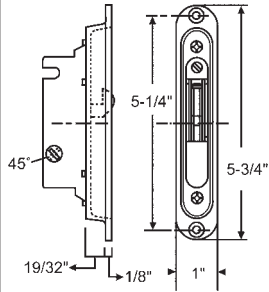

**16-441-45**  
Pocket Trim Plate with 16-175.  
Brass Plated

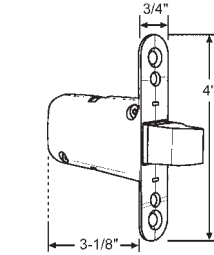

Part #	Finish
56-102LH	Shown
56-102RH	Opposite

Inactive Door  
Peachtree

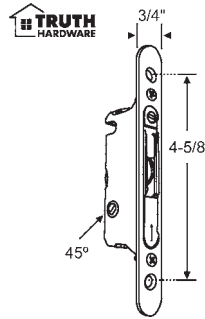

Part #	Finish
16-363-45	Brass Plated
16-363-45SS	Stainless Steel

With Faceplate and 16-175

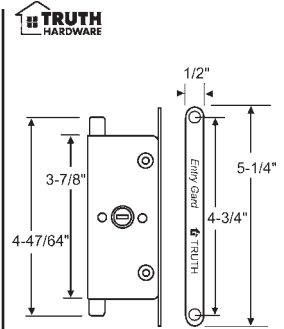

**16-685**  
Multi Point

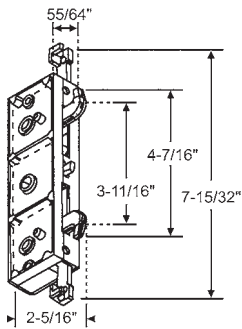

**16-542**  
Milgard Classic Series

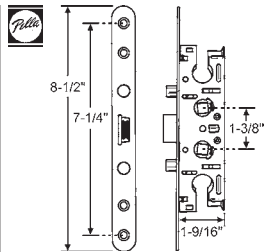

Part #	Finish
19-504B	Black
19-504G	Green
19-504PY	Putty
19-504TN	Tan
19-504W	White

Storm Door Mortise Lock

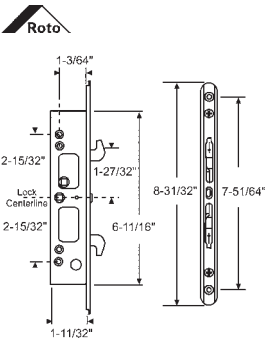

**16-460**  
2-Point Patio Door Lock

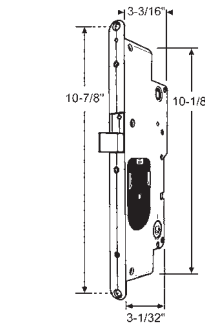

Part #	Hand
56-101RH	Shown
56-101LH	Opposite

Peachtree/Citadel

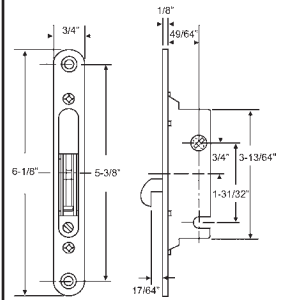

**16-333**  
Peachtree

## Keepers

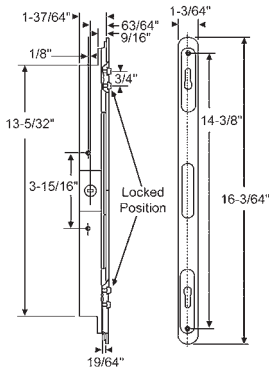

**16-440W**  
With Trimplate

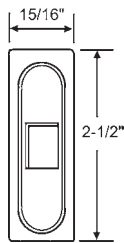

**12-303**  
Escutcheon Plate Black Plastic  
Miller

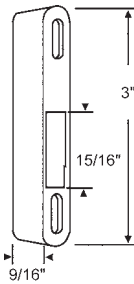

**900-8856**  
Die Cast Keeper for 900-9169

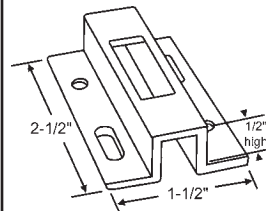

**12-299W**  
White

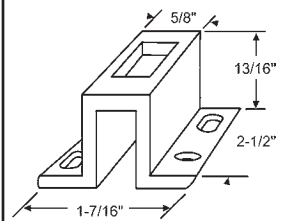

Part #	Finish
12-290W	White
12-290AD	Almond

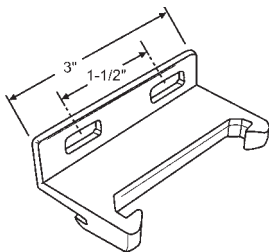

**900-69**  
Die Cast  
Yale Ogron

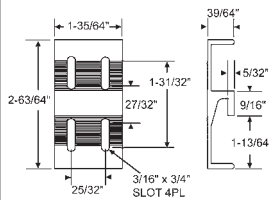

**12-286W**  
White, Four Slot

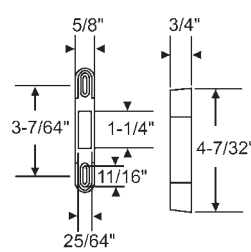

**12-294**  
Yellow Chromate Plated

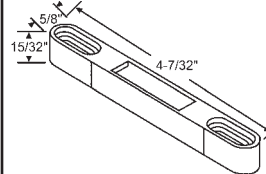

**900-17355**  
Die Cast  
Peachtree

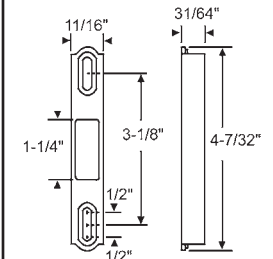

**12-271**

## Keepers

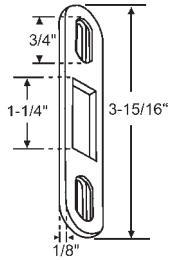

**12-272**  
Flat. For 13-247 & 13-248 Patio Door Handles

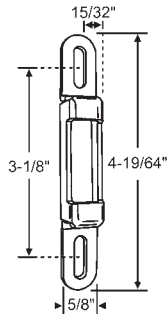

Part #	Finish
12-319	Dichromate
12-319SS	Stainless

13/64" x 11/16" Elongated Holes

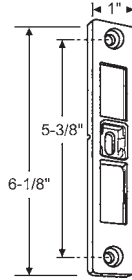

Part #	Finish
12-329STW	Satin White
12-329TN	Tan

Strike Plate. Used with 16-542 Milgard

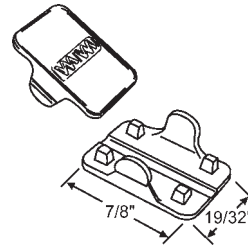

**12-330**  
Strike Plate Screen Cover. Plated. Used with 16-542 Milgard

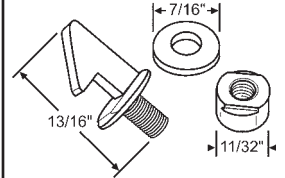

**900-61**  
w/ Nut & Nylon Washer  
Patio Door Keeper  
Daryl

## Latches

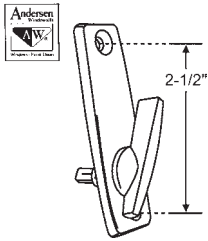

**750-1278303**  
Stone

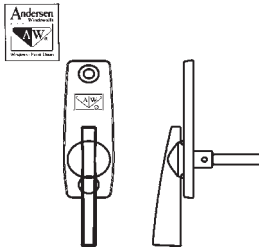

No Longer Available.  
Use: 750-2573611

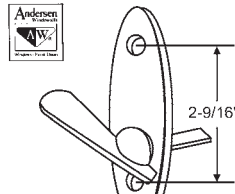

Part #	Finish
750-2573611	Stone
750-2573609	White

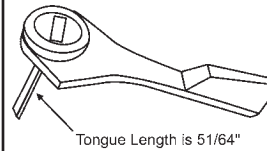

**900-11040**  
Turn Lever with Tailpiece  
Black

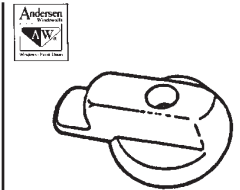

**750-0924602**  
Stone

## Lock Bars



**750-1997305**  
Stone

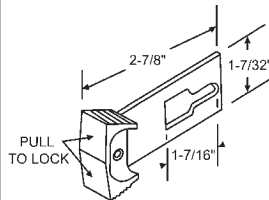

**16-188**  
Lock Bar Without Key  
Capitol

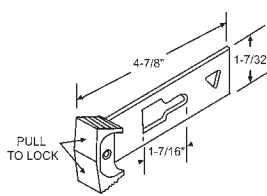

**16-230**  
4-7/8" Lock Bar  
Capitol

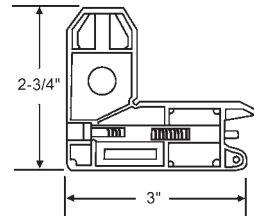

**16-116-2**  
Screen Corner Bracket Assembly  
with Screw. 2 per Pack

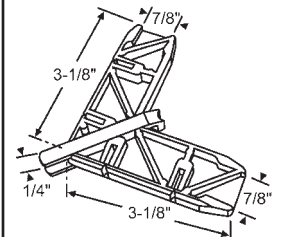

**16-361PW**  
White Nylon Miter Corner  
Use on Door 991M-999

## Repair Tracks

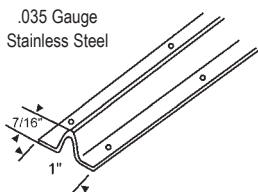

**16-251**  
Replacement Track Cover.  
8' Lengths. Sold in multiples of 5 only. Heavy duty. Recommended for tracks that are too corroded to use 16-115. Repairman's "first choice" in door replacement track.

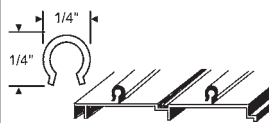

Part #	Length	Minimum Order
16-115	8ft.	(10 8ft. Lengths)
16-115-6	6ft.	(10 6 ft. Lengths)

Replace bent or broken door tracks with stainless steel replacement tracks. Easy to use. Snaps into place over old broken track.

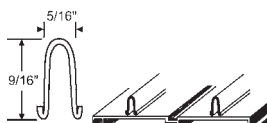

Part #	Length	Minimum Order
16-115BS	8ft.	(5 8ft. Lengths)

Replace bent or broken door tracks with stainless steel replacement tracks. Easy to use. Snaps into place over old broken track.

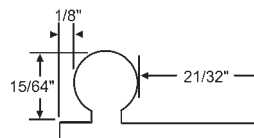

Part #	Length	Finish
16-217-6	6ft.	Anodized
16-217-8	8ft.	Anodized

Glass Door Track Extrusions  
1/16" Thick x 15/16" Wide

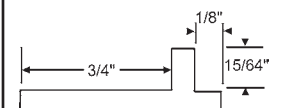

Part #	Length	Finish
16-219-6	6ft.	Anodized
16-219-8	8ft.	Anodized

Screen Door Track Extrusions  
1/16" Thick x 15/16" Wide.