

Bi-Fold Closet Door Pin Assemblies

In Order by Pin Diameter & Height

1/4" DIAMETER

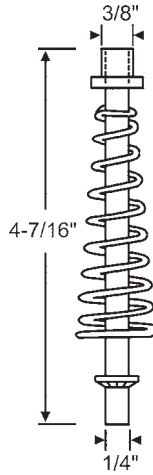
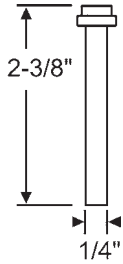

Assembly # 1-250	
Pin w/Cap	1-243
Cap	4-119
Spring	5-51
Push Nut	6-122

Fenestra

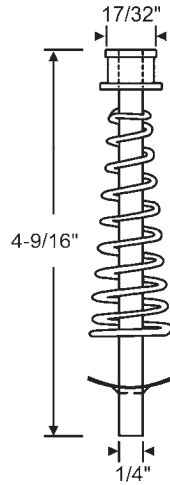

Assembly # 1-161	
Pin w/Cap	1-160
Cap	4-105
Spring	5-51
Tinnerman Clip	6-143

National

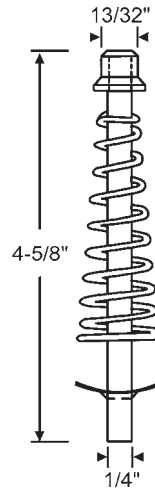

Assembly # 1-159	
Pin w/Cap	1-158
Cap	4-115
Spring	5-51
Tinnerman Clip	6-143

Peachtree

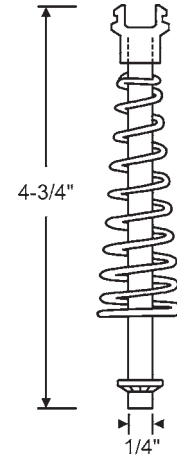

Assembly # 1-131	
Pin w/Cap	1-130
Cap	4-108
Spring	5-51
Push Nut	6-122

National

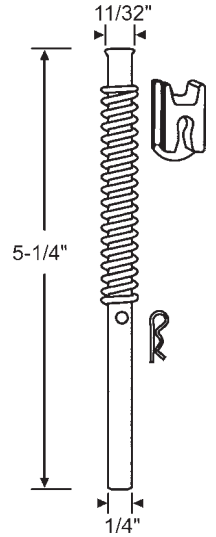

Assembly # 1-145	
Guide Cap	4-111
Spring	5-50
Hairpin Clip	6-136

Leigh/Monarch

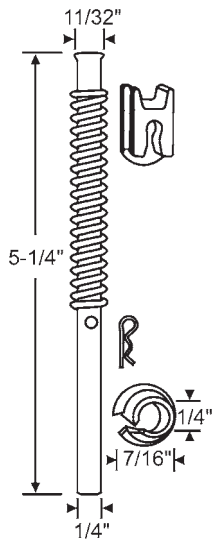

Assembly # 1-145A	
Guide Cap	4-111
Spring	5-50
Hairpin Clip	6-136
Grommet (2x)	8-259

Leigh/Monarch

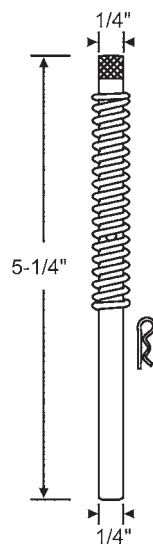

Assembly # 1-153	
Spring	5-50
Hairpin Clip	6-136

Leigh/Monarch

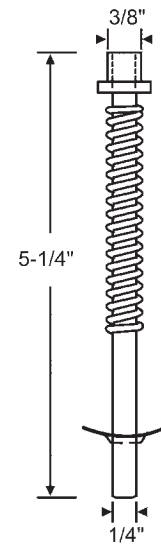

Assembly # 1-236	
Pin w/Cap	1-238
Cap	4-119
Spring	5-50
Tinnerman Clip	6-143

Fenestra

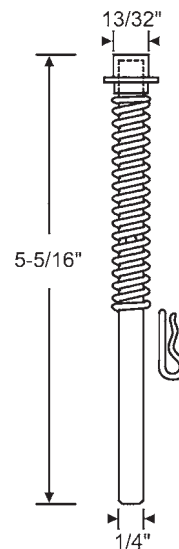

Assembly # 1-163	
Pin w/Cap	1-162
Cap	4-104
Spring	5-50
Hairpin Clip	6-136

Leigh/Monarch

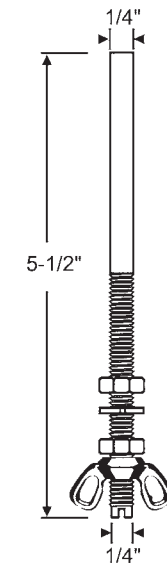

Assembly # 1-147	
Hex nut	6-129
Lock Washer	6-123
Wing Nut	6-132

Leigh/Monarch

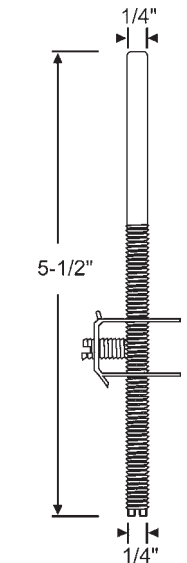

Assembly # 1-165	
Clevis w/Screw	6-134

Leigh/Monarch

TOLL FREE: 800-352-0800

2011 PGI©

strybuc

319

Closet Door Hardware

Bi-Fold Closet Door Pin Assemblies

1/4" DIAMETER

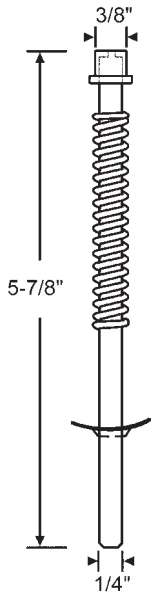

Assembly # 1-170	
Pin w/Cap	1-169
Cap	4-114
Spring	5-50
Tinnerman Clip	6-143

Benchmark

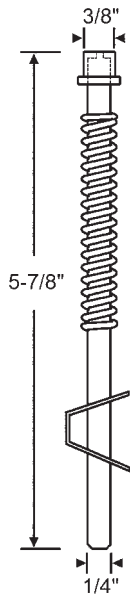

Assembly # 1-237	
Pin w/Cap	1-169
Cap	4-114
Spring	5-50
Compression Retainer	6-101

Benchmark

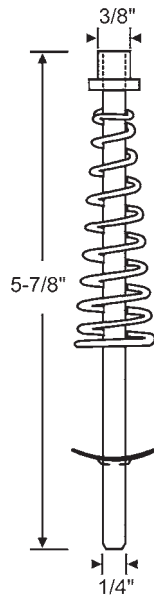

Assembly # 1-259	
Pin w/Cap	1-156K
Cap	4-119
Spring	5-51
Tinnerman Clip	6-143

Fenestra

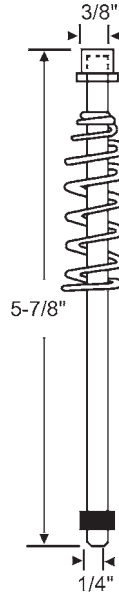

Assembly # 1-235	
Pin w/Cap	1-156
Cap	4-114
Spring	5-59
Bushing	6-107

Fenestra

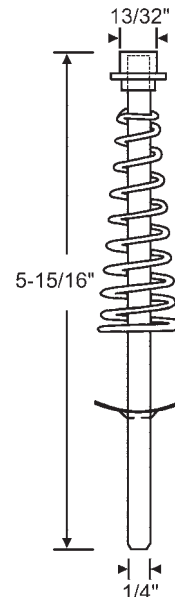

Assembly # 1-172	
Pin w/Cap	1-171
Cap	4-104
Spring	5-51
Tinnerman Clip	6-143

Leigh/Monarch

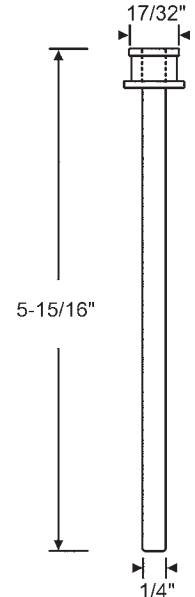

Assembly # 1-258	
Cap	4-105

National

5/16" DIAMETER

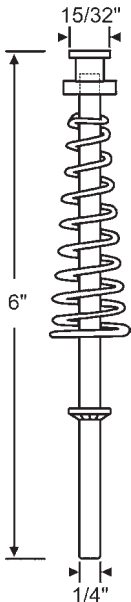

Assembly # 1-157	
Pin w/Cap	1-156
Cap	4-107
Spring	5-51
Push Nut	6-122

National

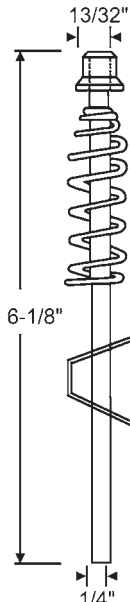

Assembly # 1-224	
Pin w/Cap	1-223
Cap	4-115
Spring	5-59
Compression Retainer	6-143

Peachtree

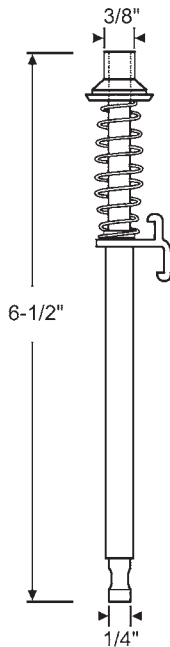

Assembly # 1-102	
Cap	4-120

With Plastic Sleeve

Slimfold

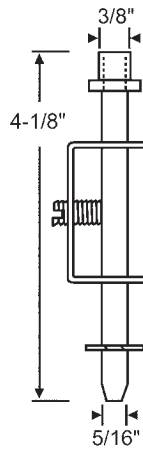

Assembly # 1-137	
Pin w/Cap	1-136
Cap	4-119
Clevis w/Screw	6-102
E-Ring	6-109

Fenestra

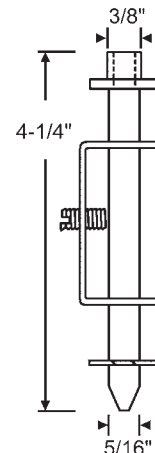

Assembly # 1-241	
Pin w/Cap	1-239
Cap	4-128
Clevis w/Screw	6-105
E-Ring	6-109

Fenestra

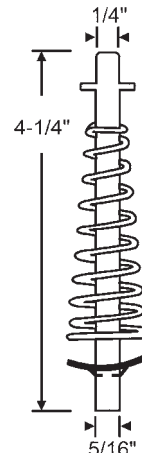

Assembly # 1-190	
Spring	5-51
Tinnerman Clip	6-141
E-Ring	6-109

Used with 1-186

National

Bi-Fold Closet Door Pin Assemblies

5/16" DIAMETER

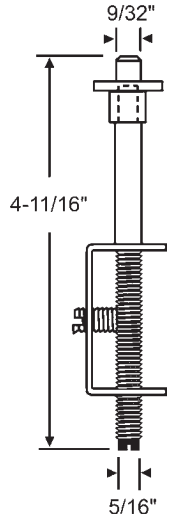
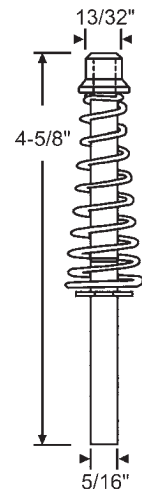
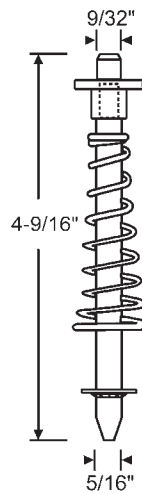
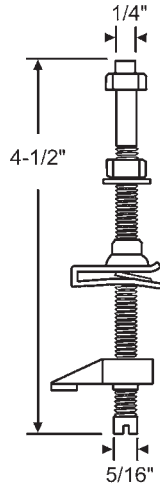
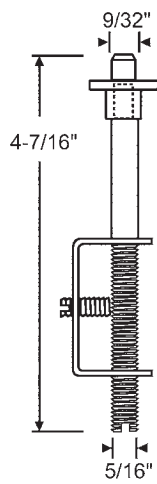
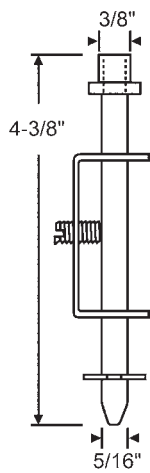

Assembly # 1-201	
Pin w/Cap	1-200
Cap	4-119
Clevis w/Screw	6-105
E-Ring	6-110

Fenestra

Assembly # 1-180	
Pin w/Cap	1-179
Cap	4-118
Clevis w/Screw	6-103

Fenestra

Assembly # 1-186	
Lock Washer	6-115
Hex Nut	6-128
Bushing	6-139
Nut	6-140

National

Assembly # 1-251	
Pin w/Cap	1-202
Cap	4-118
Spring	5-62
Push Nut	6-111

Fenestra

Assembly # 1-133	
Pin w/Cap	1-132
Cap	4-115
Spring	5-51
E-Ring	6-112

Peachtree

Assembly # 1-220	
Cap	4-118
Clevis	6-103

Fenestra

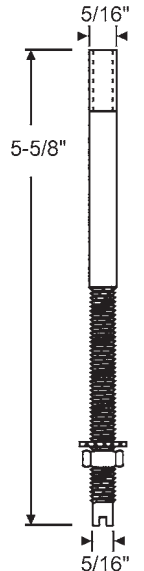
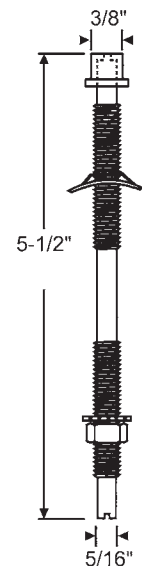
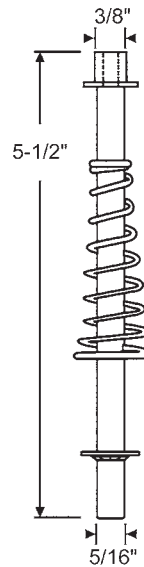
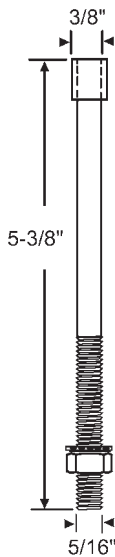
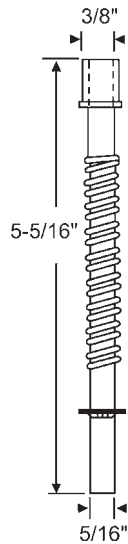
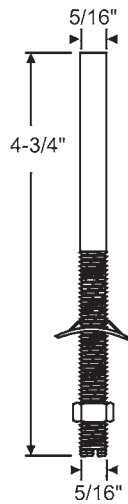

Assembly # 1-209	
Threaded Tinnerman	6-125
Hex Nut	6-128

Keller

Assembly # 1-184	
Cap	4-103
Spring	5-50
Push Nut	6-111

Slimfold

Assembly # 1-127	
Cap	4-110
Lock Washer	6-118
Hex Nut	6-128

Assembly # 1-252	
Pin w/Cap	1-261
Spring	5-62
Push Nut	6-111

Assembly # 1-123	
Cap	4-114
Tooth Lock Washer	6-118
Threaded Tinnerman	6-125
Hex Nut	6-128

Benchmark

Assembly # 1-195	
Pin w/Cap	1-194
Cap	4-126
Hex Nut	6-128
Tooth Lock Washer	6-118

Floataway

TOLL FREE: 800-352-0800

2011 PGI©

strybug
FINE TUNING

321

Closet Door Hardware

Bi-Fold Closet Door Pin Assemblies

5/16" DIAMETER

3/8" DIAMETER

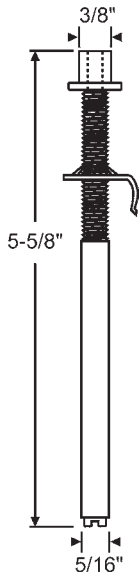

Assembly # 1-174	
Cap	4-117
Threaded Tinnerman	6-145

Slimfold

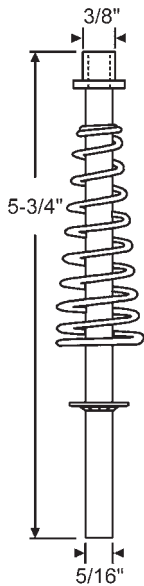

Assembly # 1-176	
Pin w/Cap	1-175
Cap	4-119
Spring	5-51
Push Nut	6-111

Fenestra

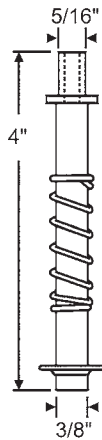

Assembly # 1-257	
Cap	4-130
Spring	5-60
Push Nut	6-100

Peachtree/Floataway

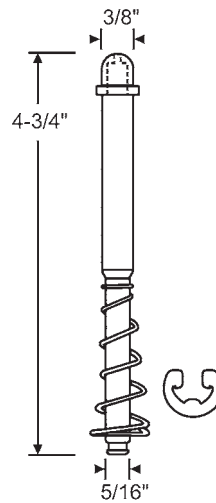

Assembly # 1-129	
Pin w/Cap	1-128
Cap	4-116
Spring	5-58
E-Ring	6-112

Floataway

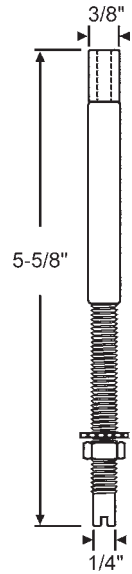

Assembly # 1-101	
Pin w/Cap	1-100
Cap	4-101
Hex Nut	6-128
Tooth Lock Washer	6-118

Floataway

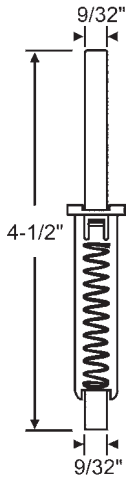

Assembly # 1-107

**Peachtree
Floataway**

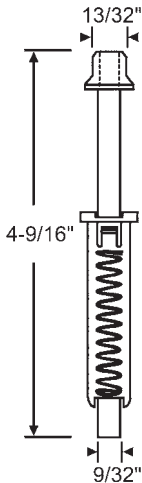

Assembly # 1-108	
Cap	4-127

**Peachtree
Floataway**

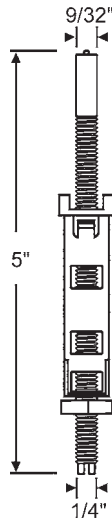

Assembly # 1-106	
Hex Nut	6-128
Pin Sleeve	8-308

**Peachtree
Floataway**

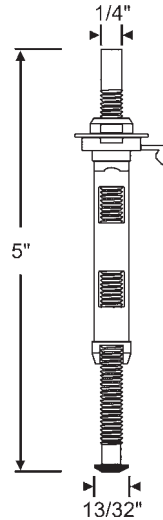

Assembly # 1-103	
Square Nut	6-157
Speed Nut	6-161
Pin Sleeve	900-6656

Floataway

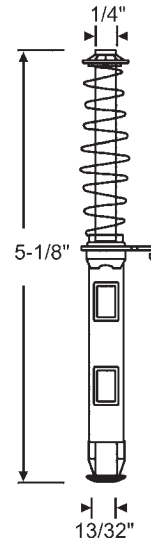

Assembly # 1-104	
Spring	5-59
Push Nut	6-122

Floataway

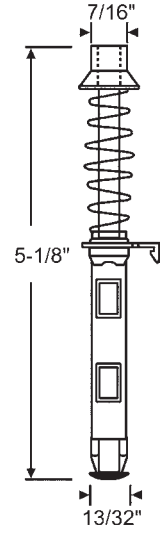

Assembly # 1-105	
Cap	4-106
Spring	5-59

Floataway

Bi-Fold Closet Door Caps

Caps Shown Actual Size

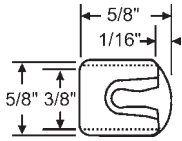

4-100
5/16" Thick
Fits Pin 1-151
Leigh/Monarch

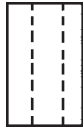

4-101
Fits Pins 1-100, 1-149, 1-101,
1-232, 1-148
Floataway

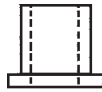

4-103
Fits Pins 1-183, 1-184
Slimfold

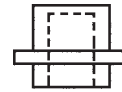

4-104
Fits Pins 1-162, 1-171, 1-163,
1-172, 1-172K
Leigh/Monarch

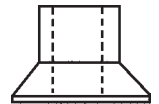

4-106
Fits Pins 1-105, 900-9422
Floataway

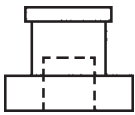

4-107
Fits Pins 1-156, 1-157
National

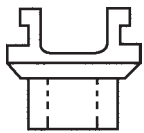

4-108
Fits Pins 1-130, 1-131
National



4-111
Fits Pins 1-145, 1-188, 1-226
1-144A, 1-145A
Leigh/Monarch

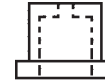

4-114
Fits Pins 1-170, 1-123,
1-235, 1-169, 1-237
Benchmark

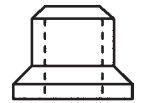

4-115
Fits Pins 1-132, 1-159, 1-133,
900-14476, 900-17552, 1-223,
1-158, 1-224, 1-262, 900-8841A
Peachtree

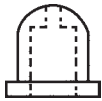

4-116
Fits Pins 1-128, 1-228,
1-129, 1-229
Floataway

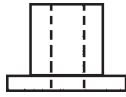

4-117
Fits Pins 1-174, 1-197,
1-232, 1-261
Slimfold

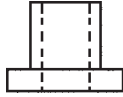

4-119
Fits Pins 1-136, 1-175,
1-204, 1-230, 1-137, 1-176,
1-205, 1-236, 1-200, 1-217,
1-238, 1-143, 1-201, 1-218,
1-260, 1-269, 1-273, 1-243,
1-244, 1-250, 1-259
Fenestra

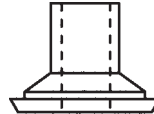

4-120
Fits Pin 1-102
Slimfold

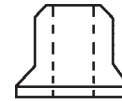

4-127
Fits Pins 1-108
Peachtree

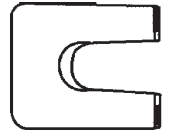

4-129
Fits Pin 1-246
Peachtree

Bi-Fold Closet Door Springs

In Order by Height

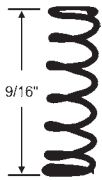

5-73
Bayform



900-9421S

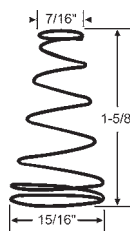

5-62
Slimfold

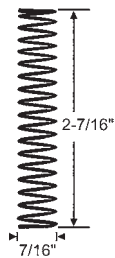

5-50
Benchmark

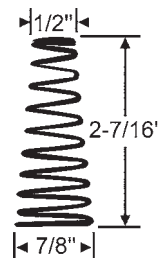

5-51

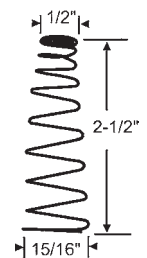

5-63

Bi-Fold Closet Door Accessories

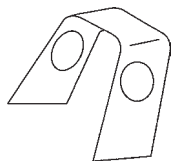

6-101
Compression Retainer for
1/4" Pins. Used with 1-224,
1-237, 1-269, 1-273



6-136
Hairpin Clip. Used with
1-144A, 1-145, 1-145A,
1-153, 1-153A, 1-163

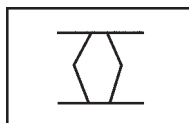

6-143
1/4" Tinnerman Clip

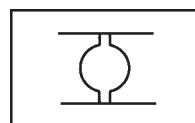

6-125
5/16" Threaded Tinnerman



Part #	Size
6-112	1/4"
6-110	5/16"
6-109	3/8"

E-Ring

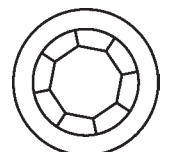

Part #	Size
6-122	1/4"
6-111	5/16"

Push Nut

Closet Door Hardware

Metal Closet Door Pivot Brackets

In Order by Length

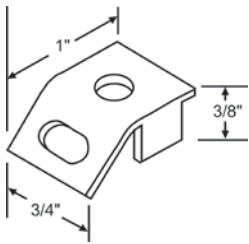

7-240
Metal
Leigh/Monarch

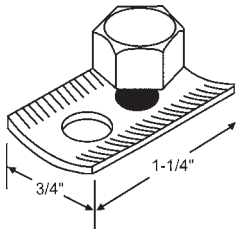

7-234
Metal
Leigh/Monarch

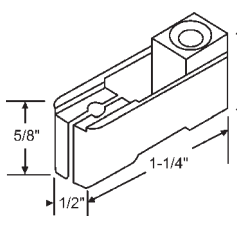

7-225
Nylon
Peachtree

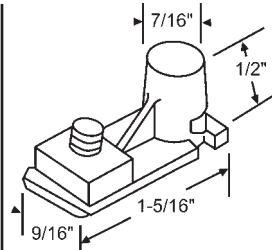

7-246
Nylon
Peachtree

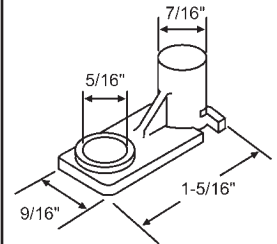

7-227
Nylon

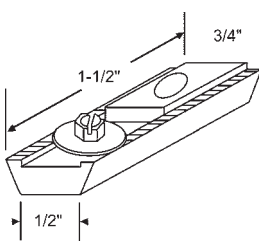

7-210A
Nylon
National

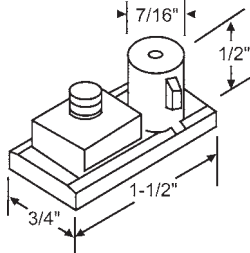

7-230
Nylon
Peachtree

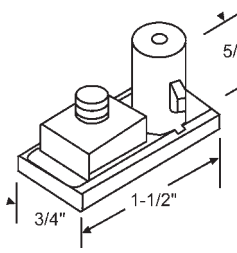

7-247
Nylon
Benchmark

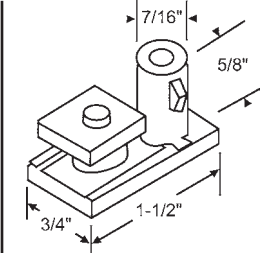

7-229
Nylon
Peachtree

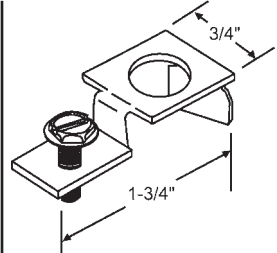

7-226
Metal
Benchmark

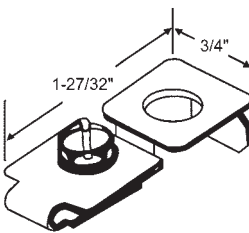

7-200
Metal
Slimfold

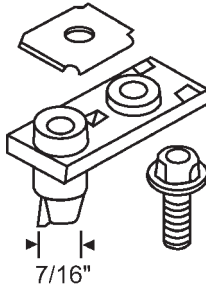

7-223
Nylon
Floataway

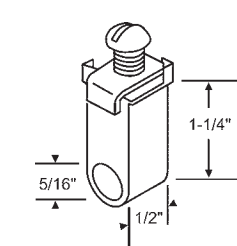

7-224
Nylon

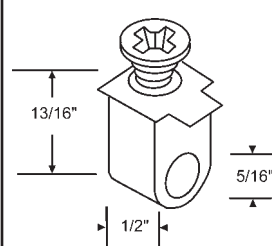

7-231
Nylon
New Style
Slimfold

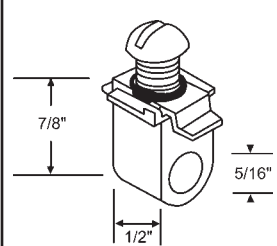

7-2310S
Nylon
Old Style
Slimfold

Metal Closet Door Nylon Grommets/Bushings/Bumpers

In Order by Height

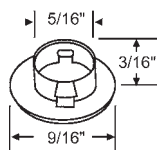

8-255
National

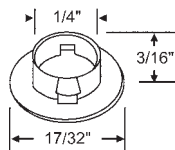

8-254
National

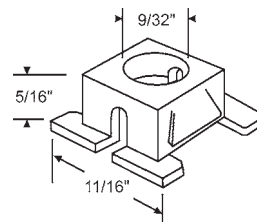

8-262
Peachtree

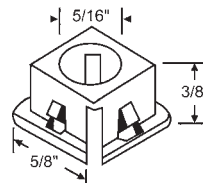

8-268
Peachtree

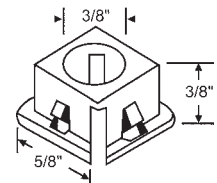

8-269
Peachtree

Metal Closet Door Nylon Grommets/Bushings/Bumpers

In Order by Height

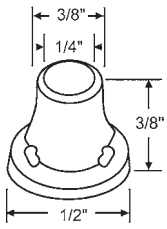

8-261
Blue
Benchmark

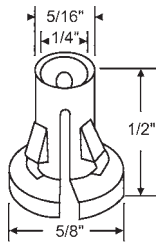

8-264
Floataway

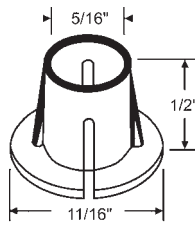

8-267
Floataway

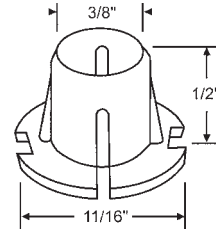

8-280
Floataway

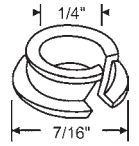

8-259
Leigh/Monarch

In Order by Length

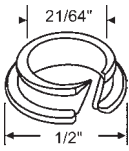

8-260
Leigh/Monarch

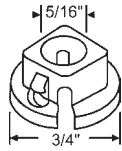

8-266
Floataway

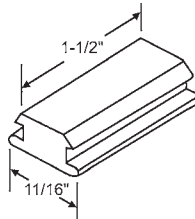

8-271
Gray
National

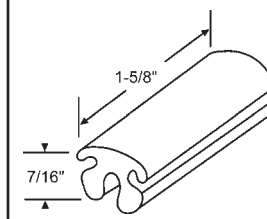

8-304
White
Floataway

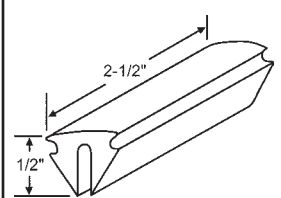

8-283
White
Benchmark

Metal Closet Door Plates & Pulls

In Order by Diameter

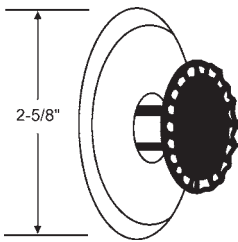

Part #	Finish
8-228B	Bronze
8-228A	Polished Aluminum

Floataway

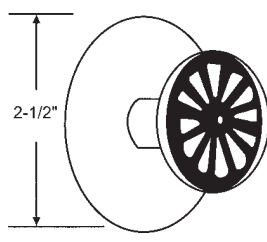

8-258
Brass with Screw
8-327 Knob, 8-321 Back Plate
Slimfold

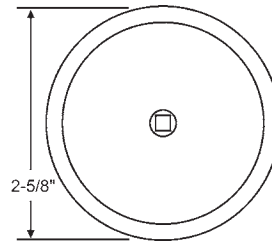

Part #	Finish
900-10221C	Chrome
900-10221	Polished Brass

Back Plate

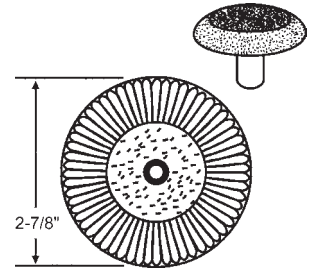

8-289
Antique Brass
Adhesive Pad Only: 900-13008
Benchmark

In Order by Height

Closet Door Track

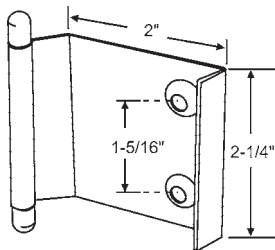

Part #	Finish
8-278	Chrome
8-278B	Gold

Door Pull Set
Slimfold

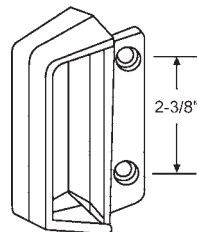

8-305
White
Peachtree Floataway

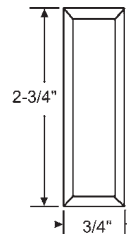

900-16101-1
Gray Mirror Pull
Self Adhesive

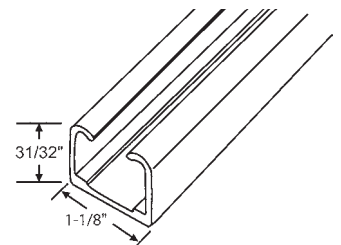

Part #	Size
8-467-3	3'
8-467-4	4'
8-467-6	6'

Kennaframe

Closet Door Hardware

Wood Closet Door Plunger Pins, Brackets, Plates & Caps

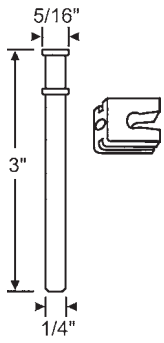

Assembly # 1-246
Guide Cap 4-129

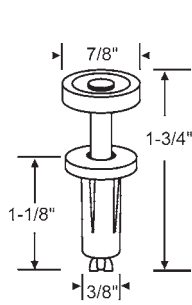

2-104
Top Rolling Guide
Spring Loaded

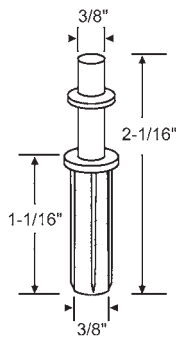

2-122

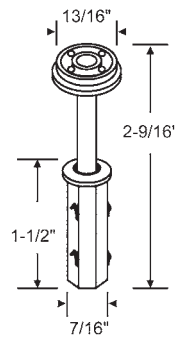

2-109
Old Stanley

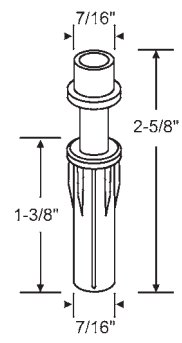

2-76
4-125 Cap Only

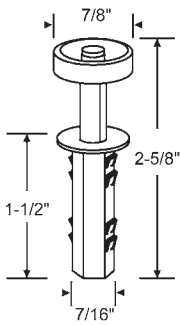

2-58
Acme

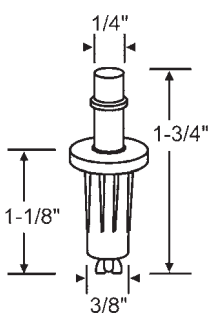

2-113

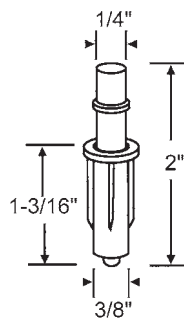

2-105

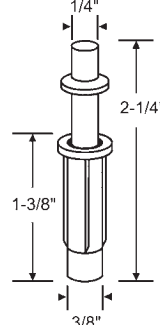

2-110
Alliance

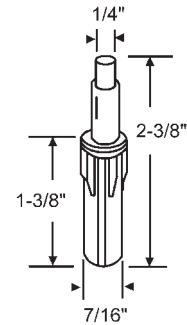

2-77

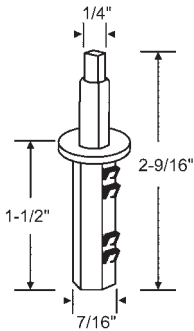

2-60
Use with 2-92
Acme

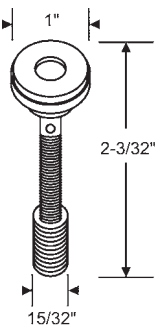

2-112
8-281 Bushing Only
2-111 Pin Only

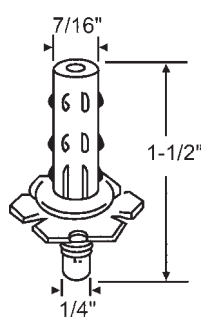

2-78

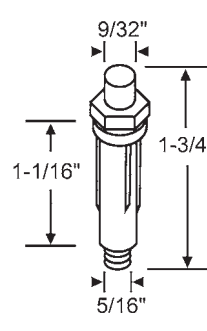

2-106

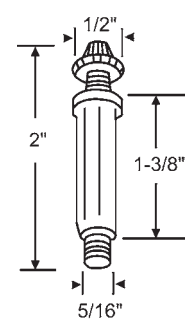

2-121

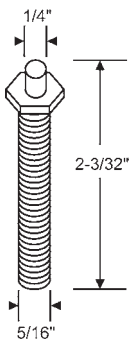

2-116

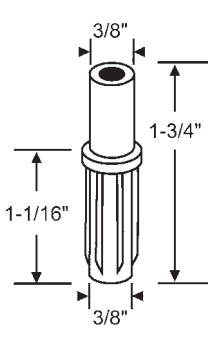

2-62

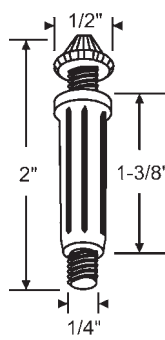

2-63

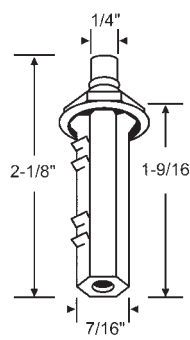

2-59
Acme

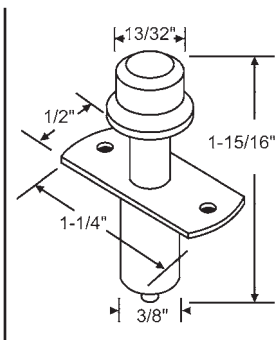

2-95
Harvey

Wood Closet Door Plunger Pins, Brackets, Plates & Caps

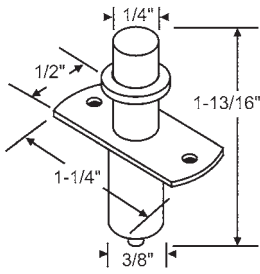

2-85

Harvey

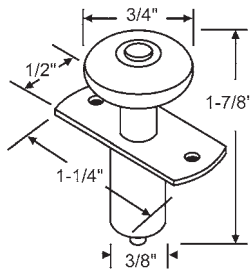

2-52

Harvey

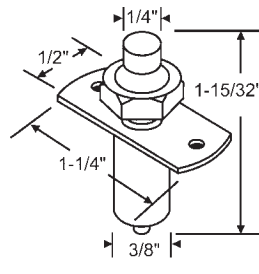

2-97

Harvey

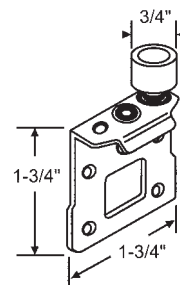

Part #	Hand
2-66	Shown
2-65	Opposite

Paniflex

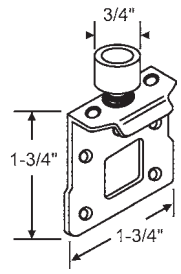

2-67

Paniflex

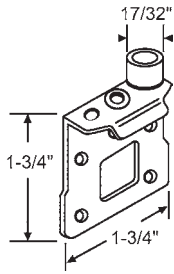

Part #	Hand
2-71	Shown
2-70	Opposite

Paniflex

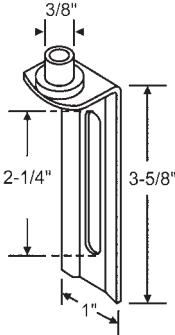

2-94

Includes Attaching
Screws 1/4" - 20" x 1/2"

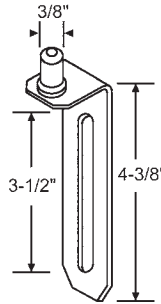

2-118

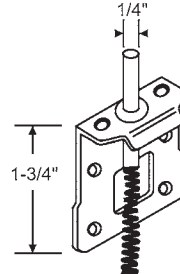

2-68

Paniflex

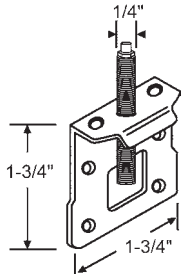

2-69

Paniflex

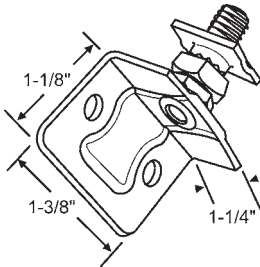

900-808-OS

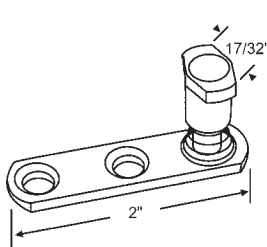

2-108

Stanley

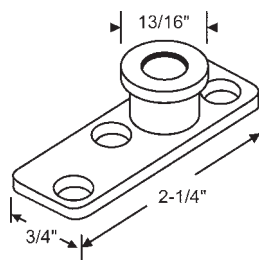

2-50

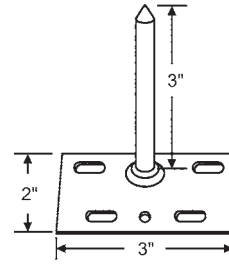

2-120

Top Plate. Use with 8-338

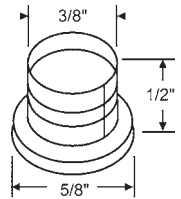

8-338

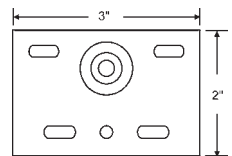

7-253

Bottom Plate

Closet Door Rollers

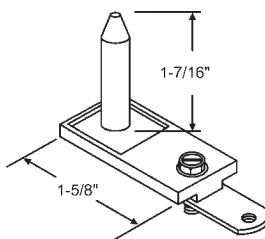

900-10518



Actual Size

4-121

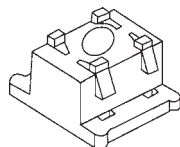

4-124

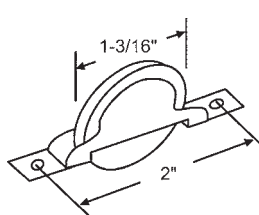

3-351

Nylon Wheel

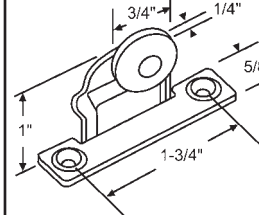

3-219

Nylon Wheel

Harvey

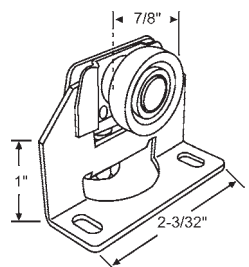

3-151

TOLL FREE: 800-352-0800

2011 PGI©

strybuc

327

Closet Door Hardware

Wood Closet Door By-Pass Hangers

In Order by Roller Diameter

3/4" Roller

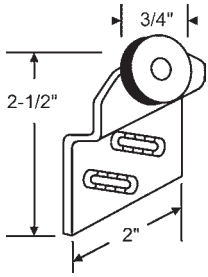

3-165
1/4" Offset
E-Z Roll

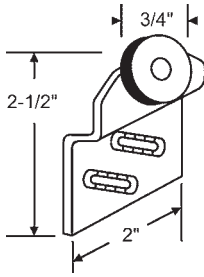

3-164
1/2" Offset
E-Z Roll

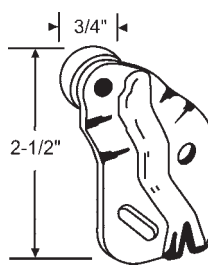

3-190
1/4" Offset
E-Z Roll

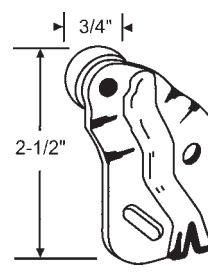

3-191
1/2" Offset
E-Z Roll

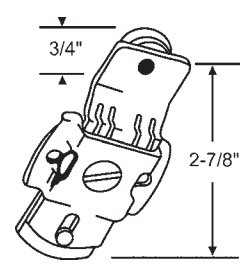

3-170
1/4" Offset

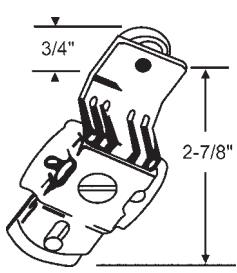

3-171
1/2" Offset

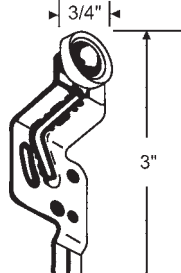

3-203
3/4" Offset
w/ Screws

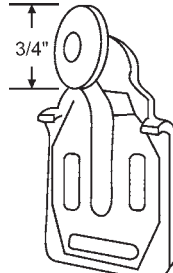

900-21054
3/4" Offset
900-21054S for Hanger w/Screws

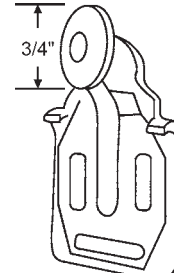

900-7798
3/8" Offset
900-7798S for Hanger w/Screws

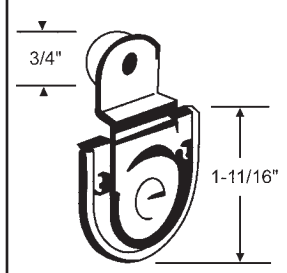

3-206
1/8" Offset
Lawrence

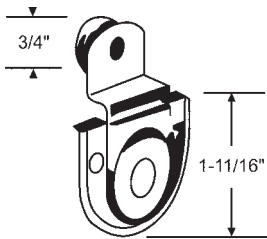

3-185
1/2" Offset
Lawrence

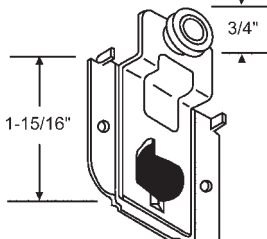

3-172
1/4" Offset
Grant

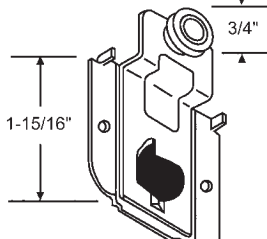

3-173
1/2" Offset
Grant

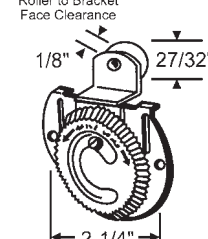

3-199
1/16" Offset
Old Stanley

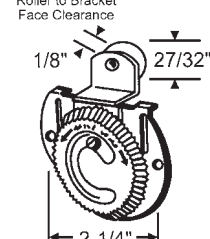

3-198
3/8" Offset
Old Stanley

27/32" Roller

7/8" Roller

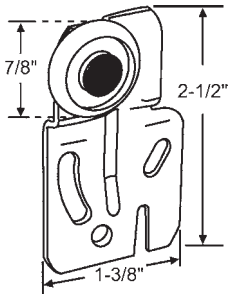

3-152
1/4" Offset
Acme

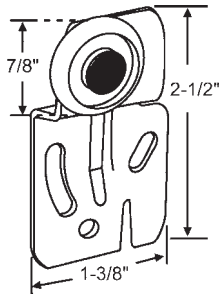

3-153
1/2" Offset
Acme

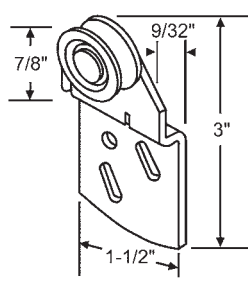

3-107
9/32" Offset
3-107S for Hanger with Screws

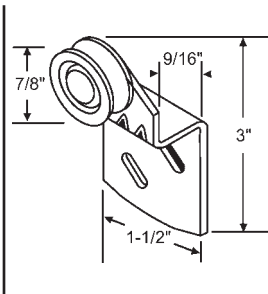

3-108
9/16" Offset
3-108S for Hanger with Screws

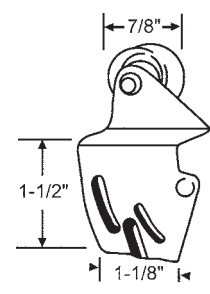

3-147
3/8" Offset

Wood Closet Door By-Pass Hangers

31/32" Roller

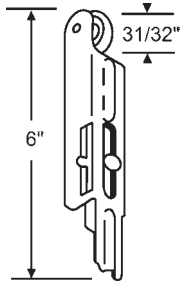

Part #	Hand
3-202	Shown
3-201	Opposite

1" Roller

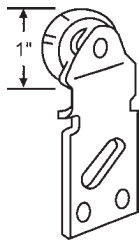

900-1304
Front Hanger w/Ball Bearing
Wheel, 1/16" Offset
E-Z Roll

1-3/16" Roller

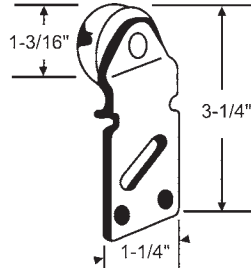

3-193
1/16" Offset

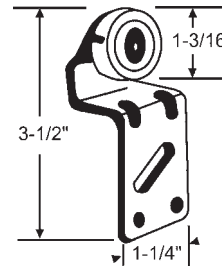

3-195
1-1/2" Offset

1-3/8" Roller



900-12272N
New Style

Wood Closet Door By-Pass Hangers - 2-Wheel

13/16" Rollers

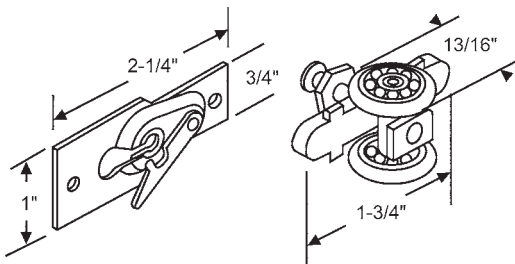

900-10534
Ball Bearing Wheels

7/8" Rollers

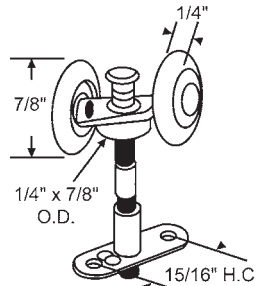

3-223

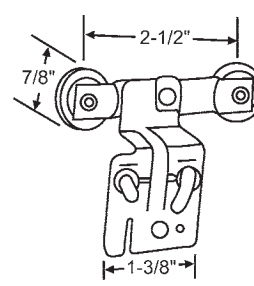

3-113
w/ Screws
1/4" Offset

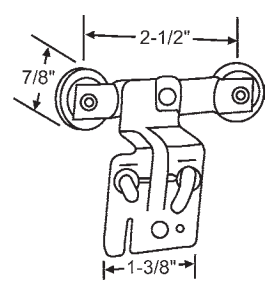

3-112
w/ Screws
1/2" Offset

Wood Closet Door By-Pass Hangers - 3-Wheel

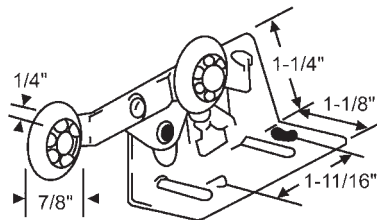

3-213

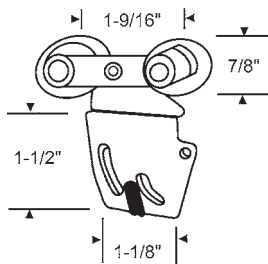

3-143
3/8" Offset

3/4" Rollers

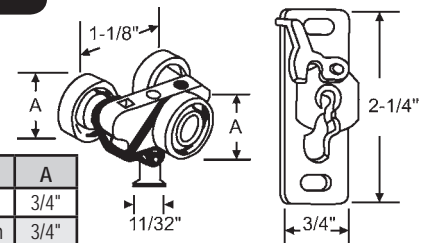

Part #	Wheel Type	A
3-141	Nylon	3/4"
3-141BB	Ball Bearing Nylon	3/4"
3-140	Nylon	1"
3-140BB	Ball Bearing Nylon	1"

Comes with 8-226 Bracket

Wood Closet Door By-Pass Hangers - 4-Wheel

3/4" Rollers

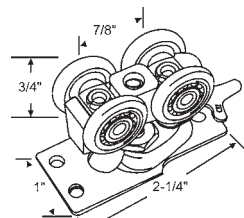

900-9746

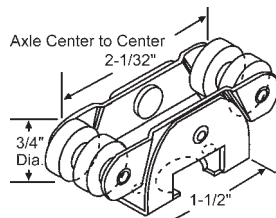

900-569

7/8" Rollers

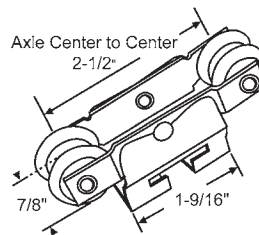

900-803-OS

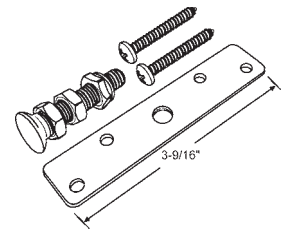

900-586

Closet Door Hardware

Wood Closet Door Panel Jacket Hangers

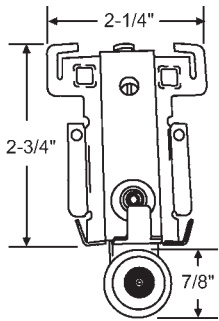

3-120

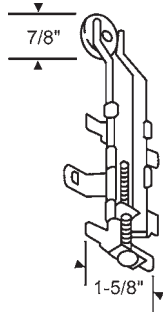

3-133

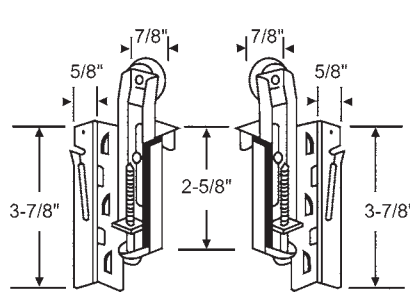

3-122A

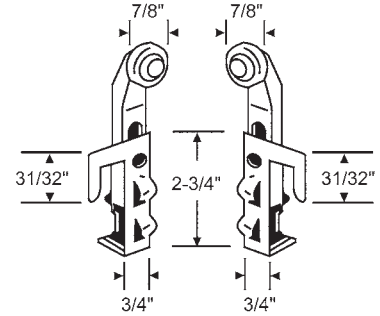

3-116A
Acme

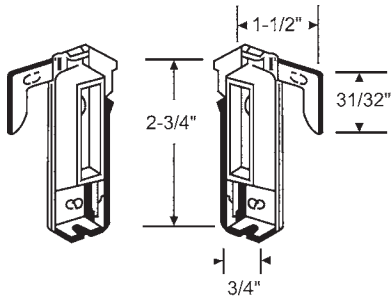

3-118A
Acme

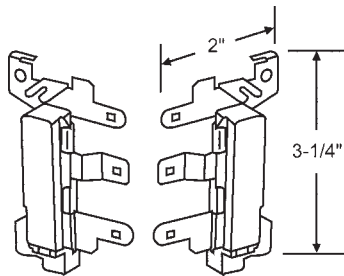

3-156A

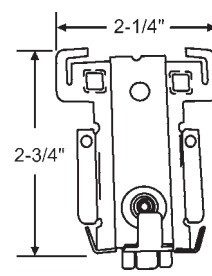

3-121

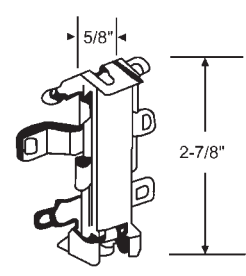

3-132

Wood Closet Door Pivot/Jamb Brackets

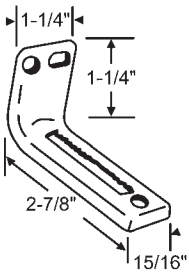

7-221
Metal

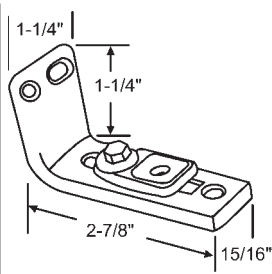

7-222
Metal with Nylon Insert
7-222-2 For 2 Brackets w/Screws

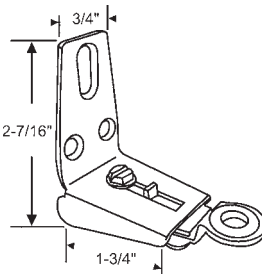

7-205
Metal

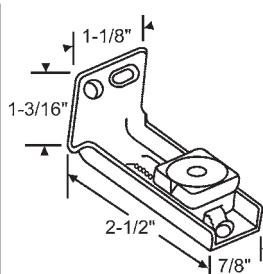

7-241
Metal with Nylon Insert

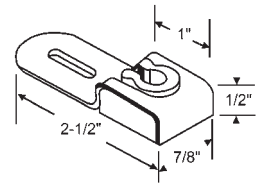

7-212
Metal with Nylon Insert

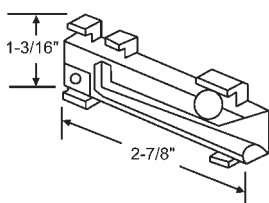

7-235A
Sold as Set (1 Left Hand, 1 Right Hand). Nylon
Paniflex

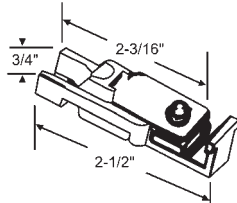

7-215
Nylon with Metal Insert

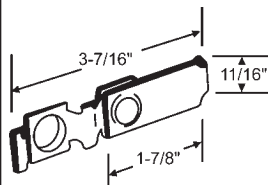

7-216
Metal

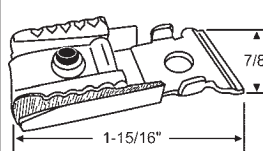

7-237
Metal
Acme

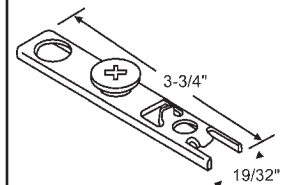

7-220N
Metal (New Style)

Closet Door Hardware

Wood Closet Door Pivot/Jamb Brackets

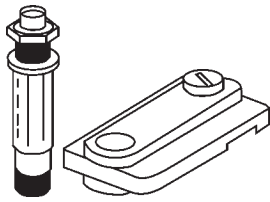

7-254

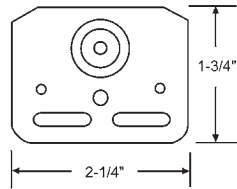

7-201
Metal
Paniflex

Wood Closet Door Pulls & Knobs

In Order by Type, then Outside Diameter

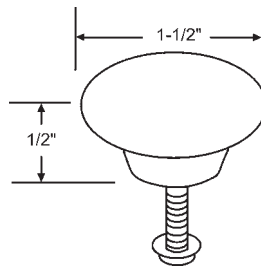

Part #	Finish
8-300	Brass Plated
8-300C	Chrome Plated

Die Cast

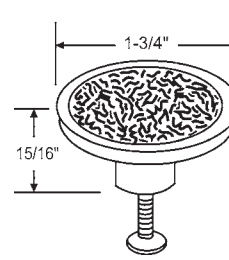

8-298
Plastic, Brown

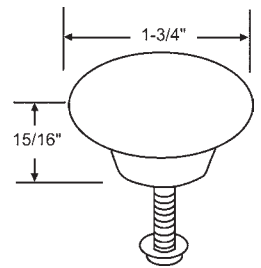

8-235
Wood, Unfinished

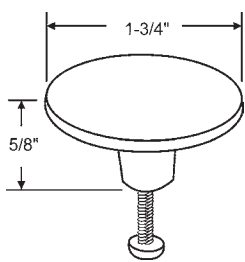

Part #	Finish
8-301	Brass Plated
8-301C	Chrome Plated

Die Cast

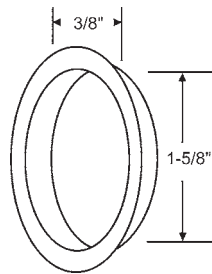

900-793
Nylon, Tan
Flush

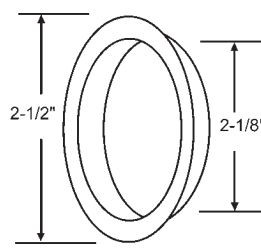

Part #	Finish
8-202	Brass Plated
8-202AB	Antique Brass Plated
8-202C	Chrome Plated

Die Cast

E-Z Roll

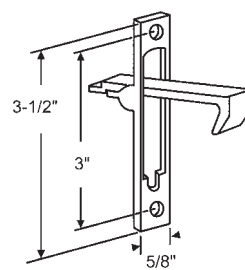

900-790
Metal, Bright Brass Finish
Flush Mount Edge Pull

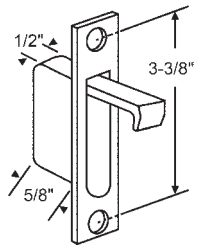

900-43
Metal, Aluminum Finish

Wood Closet Door Floor Guides/Plates

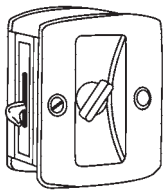

Fits
1-3/8" to
1-3/4"
Pocket
Doors

Privacy

900-14604

Stamped Steel Combination Door Pull and Privacy Lock Adjuster for 1-3/8" to 1-3/4" Doors.
Polished Brass Finish

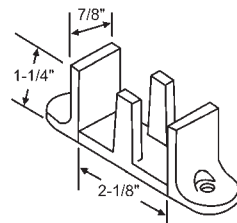

8-245
Adjusts for Doors 7/8" - 1-7/8"
Nylon

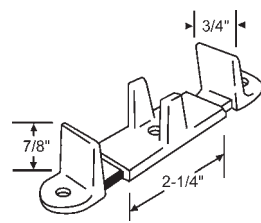

8-294
Adjusts for Doors 3/4" - 1-3/4"
Nylon, Tan - Includes Screws

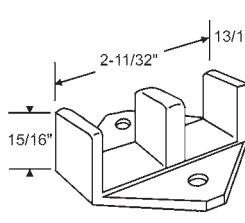

8-314
Nylon, 1 Piece. Fits 3/4" Doors
E-Z Roll

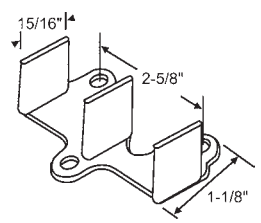

900-8114
Nylon
1 Piece. Fits 1-3/8" Doors

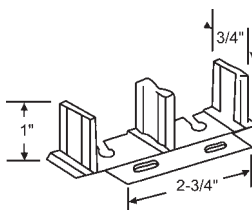

8-231

Metal w/Nylon Post. Wood Tone, Adjusts for Doors 3/4" - 1-3/8"

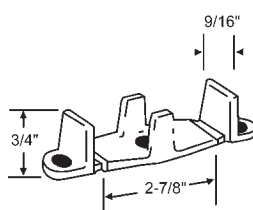

8-240
Nylon, White. Adjusts for Doors 3/4" - 1-3/4"
E-Z Roll

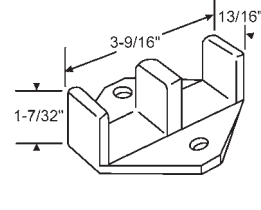

8-291
1 Piece. Floor Guide to Fit 1-3/8" Double Doors 1-1/4" High from Floor
E-Z Roll

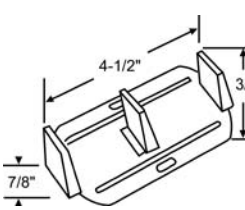

8-315
Metal with Nylon Posts For 1-3/4" Doors

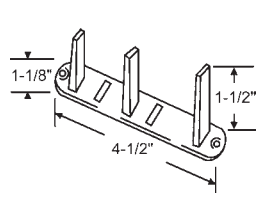

8-330
Metal with Nylon Posts Adjusts for Doors 3/4" - 1-3/8"

TOLL FREE: 800-352-0800

2011 PGI©

strybuc

331

Closet Door Hardware

Wood Closet Door Floor Guides/Plates

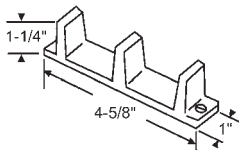

8-208
One Piece Nylon with Fixed
Guides for 1-3/8"
By-Passing Doors

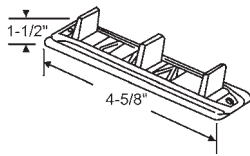

8-209-4
Metal with Nylon Posts.
Adjustable for 3/4", 1", 1-1/8" and
1-3/8" By-Passing Doors
4 per pack with Screws.

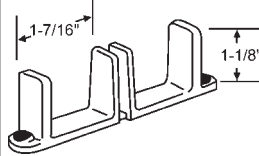

8-316
Nylon
Adjustable For 1-3/8" By-Passing
Doors 2 pieces
E-Z Roll

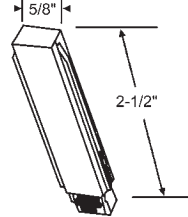

8-296
Nylon Insert Guide

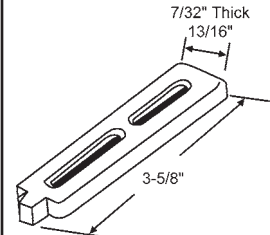

8-295
Guide Stem
Paniflex

Pivot Guide

Wood Closet Door Snuggers

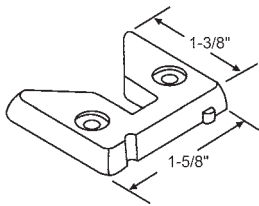

900-849
Nylon Floor Plate (Single)
Paniflex

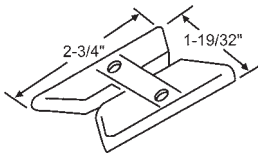

900-848
Nylon Floor Plate (Double)
Paniflex

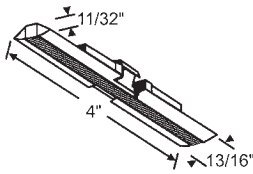

2-92
Pivot Guide
Stanley

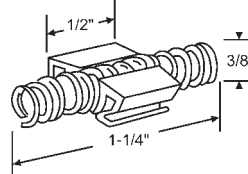

8-213

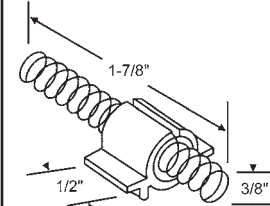

8-203

Bumpers

Miscellaneous Accessories

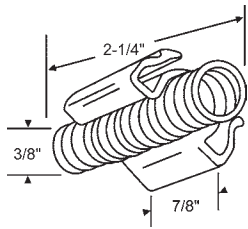

8-217

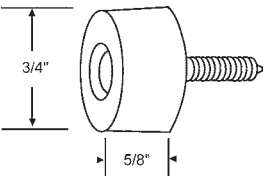

8-246
White Rubber Door Bumper
with Screw

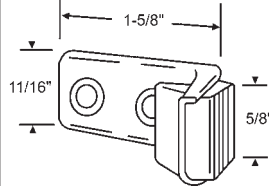

8-224
Metal Angle Stop
w/Rubber Bumper
Stanley

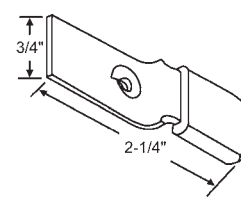

8-204
Closet Door Guide
Metal with Rubber Sleeve

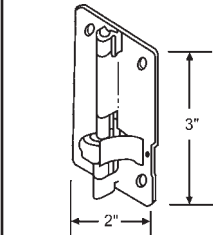

8-230
Door Hinge
Paniflex

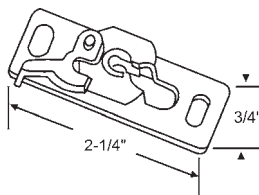

8-226
Mounting Brackets
for 3-141 Rollers

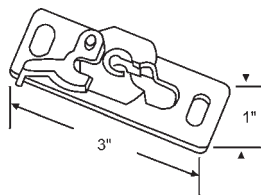

8-281
Threaded Bushing
Use with 2-112 Plunger Pin

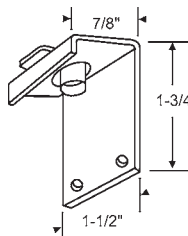

8-326
Adapter Plate

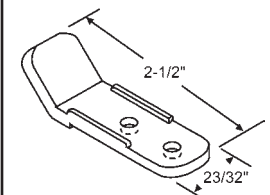

900-847
Aligner
Paniflex

Closet Door Hardware

Closet Door Miscellaneous Accessories

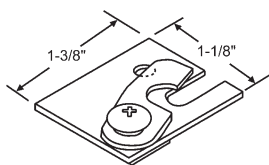

900-8986
Cam Lock Assembly

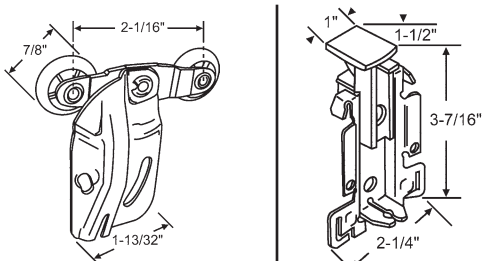

900-656
Front Dual Wheel Hanger

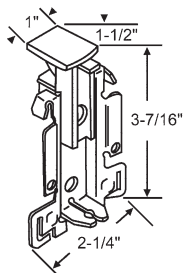

900-12459
Top Guide

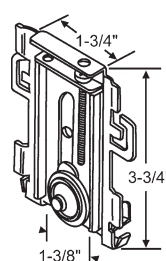

900-11827
Bottom Roller

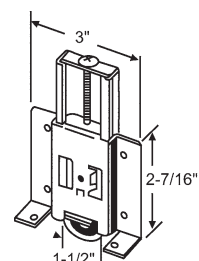

3-227
1-1/2" All Nylon Roller

CW Mirror By-Pass Door Hardware

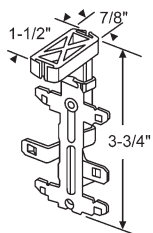

3-228
Guide Bracket

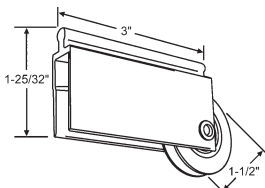

900-8319
Round-top Mirror Door Roller.
Nylon Wheel

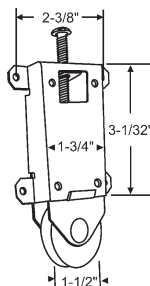

3-348
Wardrobe Door Bottom Roller
with Angled Tang. Nylon Wheel

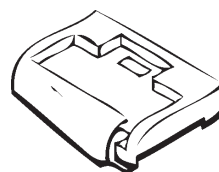

7-281
Plastic Guide

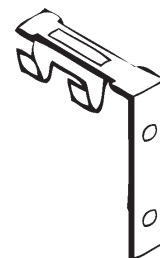

7-280
"L" Bracket

CW Mirror Bi-Fold Door Hardware

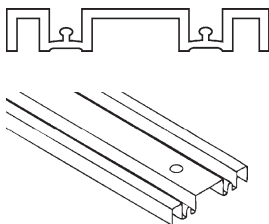

Part #	Length
8-636-5	5ft
8-636-6	6ft
8-636-8	8ft

Ultra Glide Track, 3" Wide
Steel w/ Aztec Gold Finish.

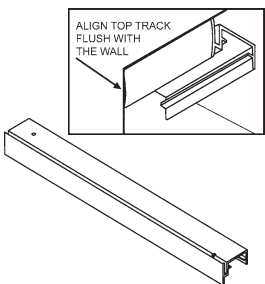

Part #	Length
8-635-5	5'
8-635-6	6'
8-635-8	8'

Top and Bottom Steel
Track. 3" Wide

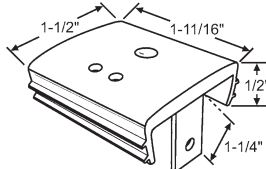

8-645
Mirror Door Guide & Bracket.
Flexible Plastic Top Guide w/
Steel Mounting Bracket
Monarch

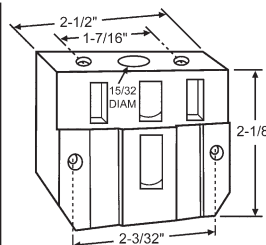

8-647
Corner Connector for Mirror Door

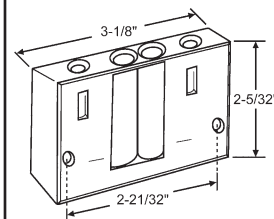

8-324
Corner Connector for Mirror Door

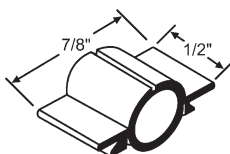

8-634
Tension Clip

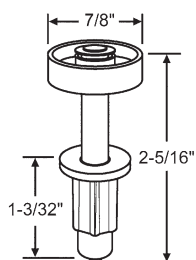

2-142
Guide Pin

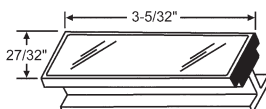

8-633
Mirror Handle

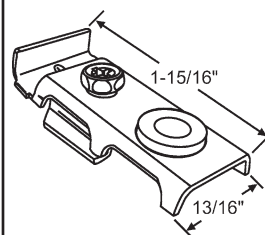

7-279
Pivot Block Clamp

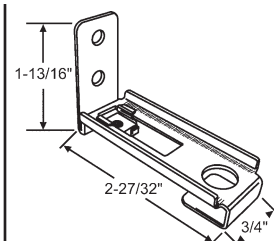

7-278
Pivot L-Bracket

TOLL FREE: 800-352-0800

2011 PGI©

strybuc
FINE FURNITURE

333

Closet Door Hardware

CW Mirror Bi-Fold Door Hardware

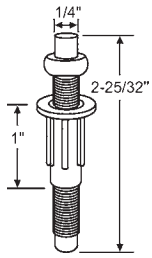

2-143

5/32" Female Hex Threaded Pivot

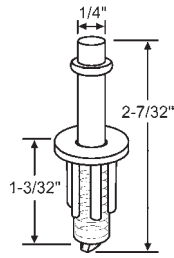

2-144

Top Spring Pivot Pin

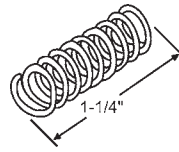

5-120

Small Spring

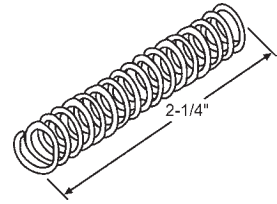

5-121

Large Spring

E-Z Roll Sliding Door Track & Accessories

All E-Z Roll Items available carded. Call your sales representative today.

Part #	Description
900-12643-4	46-1/2" for 4' Opening
900-12643-5	58-1/2" for 5' Opening
900-12643-6	70-1/2" for 6' Opening

Aluminum Track

7000 Series SLIDING DOOR TRACK SET
for 3/4" and 1-3/8" by-passing doors up to 50 lbs. each

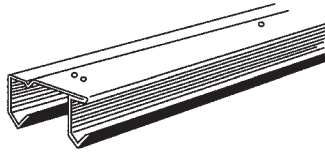

E-Z Roll Universal Hangers for Sliding Door Track Sets

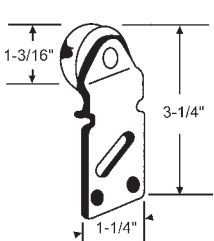

3-193

Front Hanger w/Nylon Wheel, 1/16" Offset

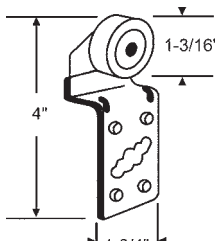

3-194

Rear Hanger w/Nylon Wheel, 5/8" Offset

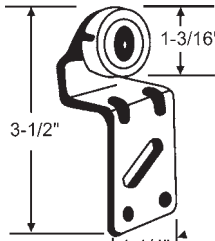

3-195

Rear Hanger w/Nylon Wheel, 1-1/2" Offset



900-1304

Front Hanger w/Ball Bearing Wheel, 1/16" Offset

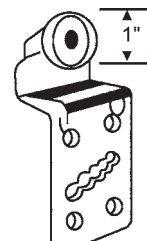

900-1305

Rear Hanger w/Ball Bearing Wheel, 1-1/2" Offset

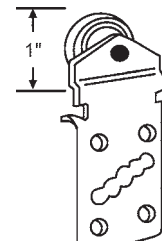

900-1308

Front Hanger w/Nylon Wheel, 1/16" Offset

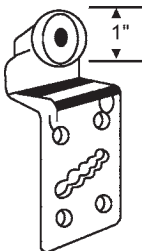

900-1305N

Rear Hanger w/Nylon Wheel, 1-1/2" Offset

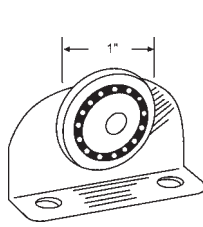

900-1306

Top Mounting Hanger for Single Pocket Door w/Ball Bearing Wheel

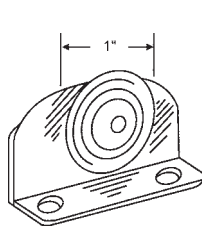

900-1307

Top Mounting Hanger for Single Pocket Door w/Nylon Wheel

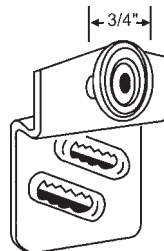

900-1314

Screen & Patio Door Hanger w/Nylon Wheel, 3/8" Offset

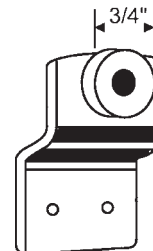

3-382

Front Hanger for Wardrobe w/Nylon Wheel, 1/8" Offset

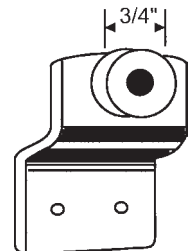

3-381

Rear Hanger for Wardrobe w/Nylon Wheel, 3/8" Offset

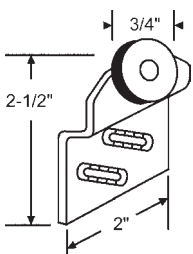

3-165

Front Hanger w/Nylon Wheel, 1/4" Offset

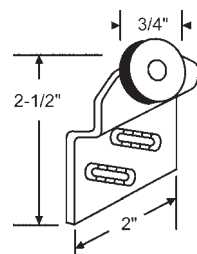

3-164

Rear Hanger w/Nylon Wheel, 1/2" Offset

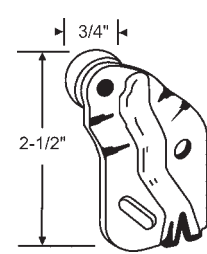

3-190

Front Hanger w/Nylon Wheel, 1/4" Offset

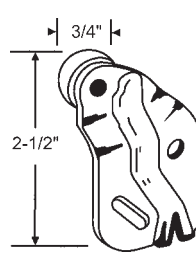

3-191

Rear Hanger w/Nylon Wheel, 1/2" Offset

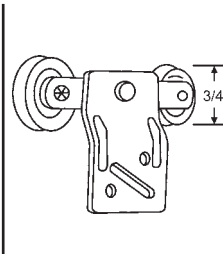

900-1301

Front Hanger Twin Wheels, 1/4" Offset

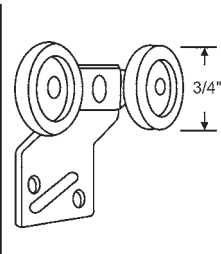

900-1300

Rear Hanger Twin Wheels, 1/2" Offset

E-Z Roll Universal Hangers for Sliding Door Track Sets

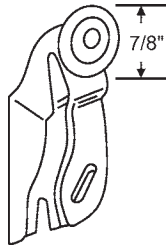

900-1318
Front Hanger w/Nylon Wheel, 3/16" Offset

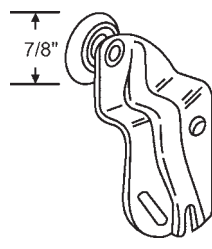

900-1317
Rear Hanger w/Nylon Wheel, 1/2" Offset

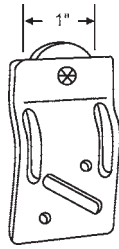

900-1312
Front Hanger 3/16" Offset

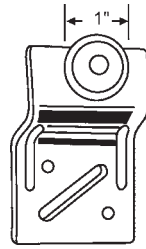

900-1313
Rear Hanger 1/2" Offset

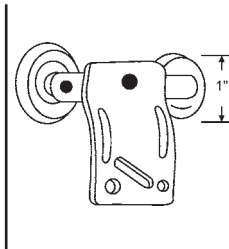

900-1298
Front Hanger Twin Wheel 3/16" Offset

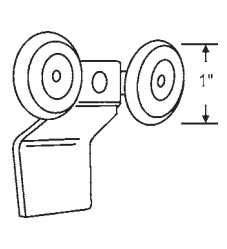

900-1299
Rear Hanger Twin Wheel 1/2" Offset

E-Z Roll Replacement Hardware for Folding Bi-fold Doors

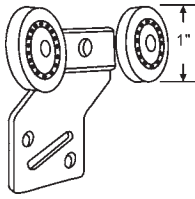

900-1302
H.D. Front Hanger Twin Wheel w/Ball Bearing Wheel, 3/16" Offset

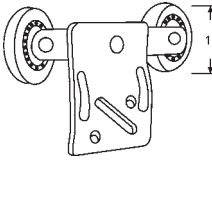

900-1303
H.D. Rear Hanger Twin Wheel w/Ball Bearing Wheel, 1/2" Offset

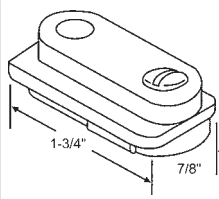

7-251
Top Bracket

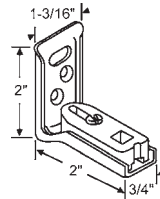

7-250
Bottom Bracket

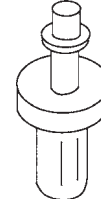

900-1325
Top Pivot Spring Loaded

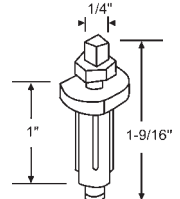

2-114
Bottom Pivot

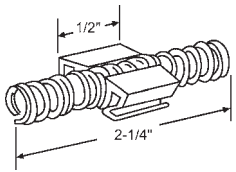

8-491
Snugger for 4 Doors

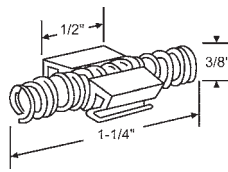

8-213
Snugger for 2 Doors

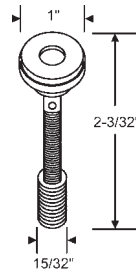

2-112
Top Rolling Guide 1" Round Nylon Wheel 2" Threaded Stem (For replacing older hardware)

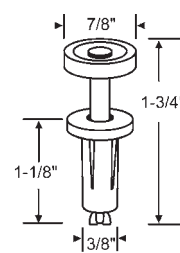

2-104
Top Rolling Guide Spring Loaded

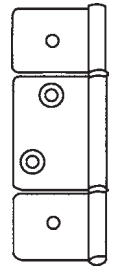

8-356
3 Wing Non Mortise Hinges

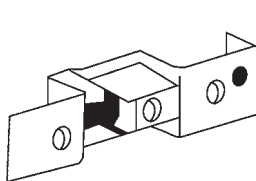

900-16386
Top Bracket

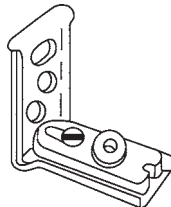

900-16387
Bottom Bracket

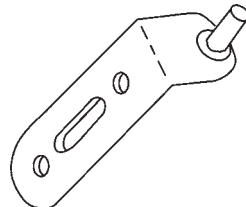

900-16388
Top Pivot

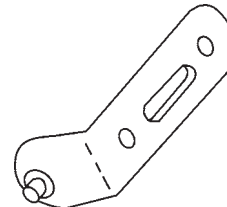

900-16389
Bottom Pivot

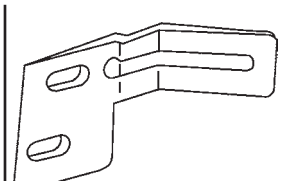

8-490
Door Aligner for 4 Doors

E-Z Roll Universal Floor Guides

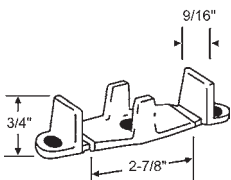

8-240
3 Piece. Floor Guide, Adjustable to Fit 3/4" or 1-3/8" Thick Doors

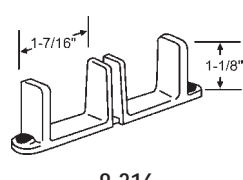

8-316
2 Piece. Floor Guide, Adjustable to Fit 1-3/8" Thick Doors, 1-1/4" High from Floor.

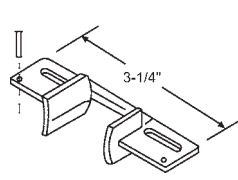

8-313
1 Piece. Nylon Guide for Single Pocket Door

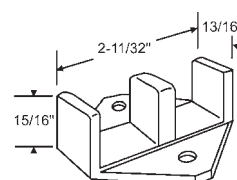

8-314
1 Piece. Floor Guide to Fit 3/4" Doors

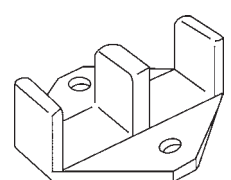

8-288
1 Piece. Floor Guide to Fit 1-1/8" Doors

Closet Door Hardware

E-Z Roll Universal Floor Guides

E-Z Roll Universal Door Finger Pulls

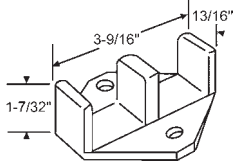

8-291

1 Piece. Floor Guide to Fit 1-3/8" Double Doors
1-1/4" High from Floor

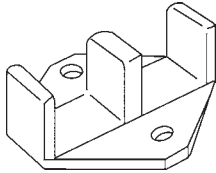

8-421

1 Piece. Floor Guide to Fit 1-3/4" Doors

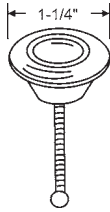

8-489

1-1/4" Nylon Plastic Pull Knob
E-Z Roll

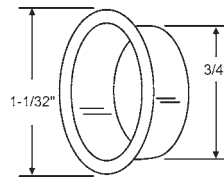

900-616

Brass Plated

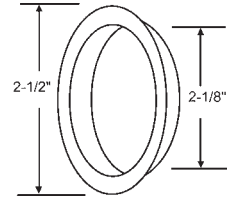

8-202

Brass Plated

Paniflex Closet Door Hardware

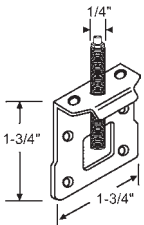

2-69

Bottom Pivot

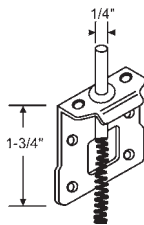

2-68

Top Pivot

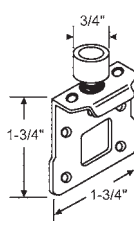

2-67

Roller Bracket

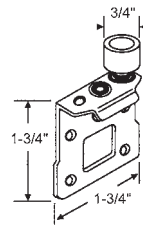

Part #	Hand
2-66	Shown
2-65	Opposite

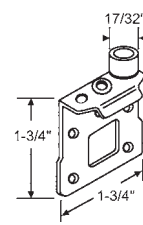

Part #	Hand
2-71	Shown
2-70	Opposite

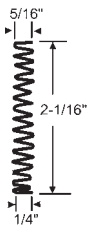

5-54

Top Pivot Spring

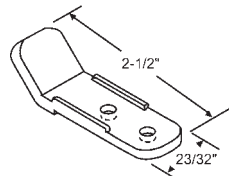

900-847

Door Aligner

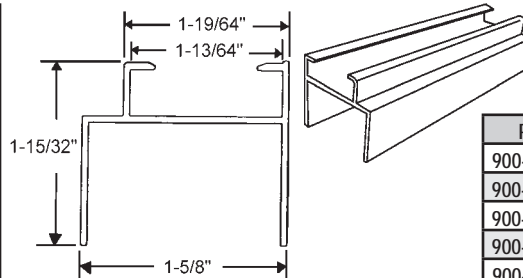

Part #	Size
900-16703-A	4 ft.
900-16703-B	6 ft.
900-16703-C	8 ft.
900-16703-D	10 ft.
900-16703-E	12 ft.

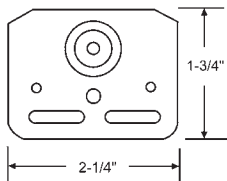

7-201

Metal Floor Plate

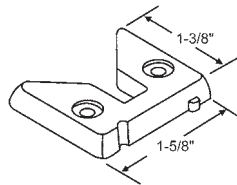

900-849

Nylon Floor Plate (Single)

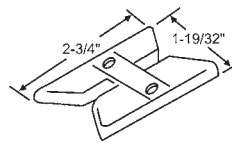

900-848

Nylon Floor Plate (Double)

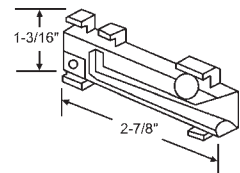

7-235A

Sold as Set (1 LH, 1 RH). Nylon

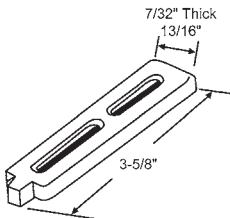

8-295

Guide System

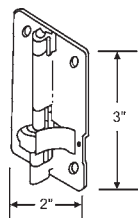

8-230

Cam Hinge

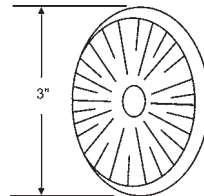

8-332

Brass Back Plate

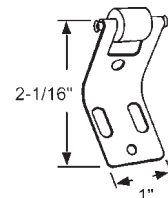

900-851

Pivot Aligner. 31/64" Dia. x 1/2" Width
Nylon Roller

Floataway Closet Door Hardware

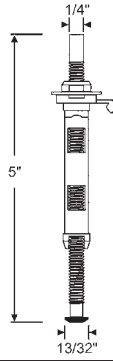

Assembly # 1-103	
Square Nut	6-157
Speed Nut	6-161
Pin Sleeve	900-6656

Pin Assembly with Plastic Sleeve

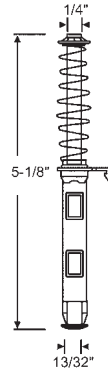

Assembly # 1-104	
Spring	5-59
Push Nut	6-122

Pin Assembly with Plastic Sleeve

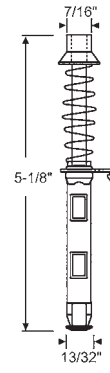

Assembly # 1-105	
Cap	4-106
Spring	5-59

Pin Assembly with Plastic Sleeve

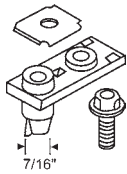

7-223
Nylon

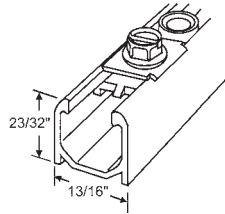

Part #	Size
8-350-3	3 ft.
8-350-4	4 ft.
8-350-6	6 ft.
8-350-8	8 ft.

Pivot Bracket Not Included

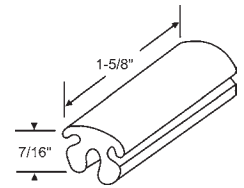

8-304
White

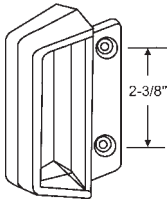

8-344*
Chrome

*call for availability

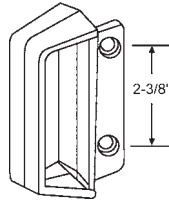

8-305
White

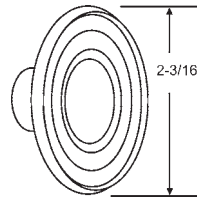

8-349
Plastic Door Knob
White

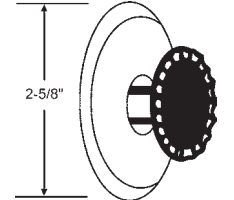

Part #	Finish
8-228B	Bronze
8-228A	Polished Aluminum

Slimfold Closet Door Hardware

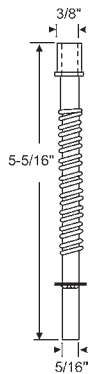

Assembly # 1-184	
Cap	4-103
Spring	5-50
Push Nut	6-111

Bi-Fold Pin Assembly

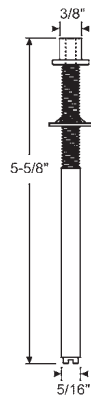

Assembly # 1-174	
Cap	4-117
Threaded Tinnerman	6-145

Bi-Fold Bottom Pivot Rod Assembly

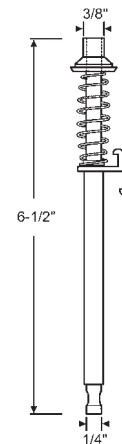

Assembly # 1-102	
Cap	4-120

Bi-Fold Spring Loaded Guide Rod Assembly

Closet Door Hardware

Slimfold Closet Door Hardware

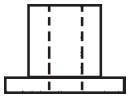

4-117

Fits Pins 1-174, 1-197,
1-232, 1-261

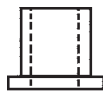

4-103

Fits Pins 1-183, 1-184

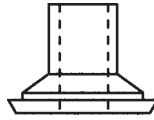

4-120

Fits Pin 1-102

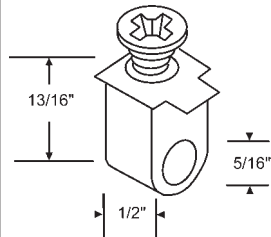

7-231

Nylon
New Style

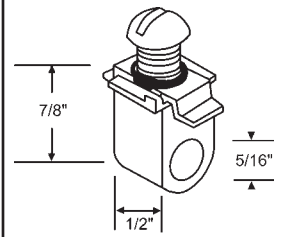

7-231OS

Nylon
Old Style

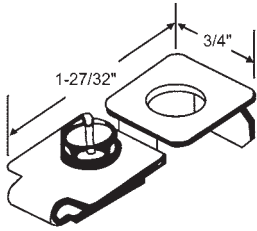

7-200

Pivot Bracket
Metal

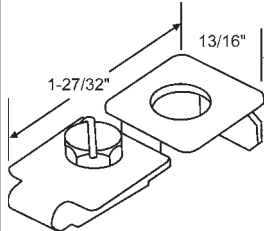

7-272

Bi-Fold Track Socket with Screw
Metal

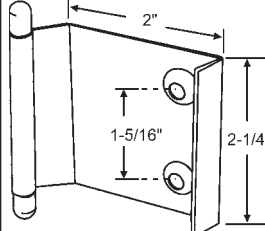

8-278

Door Pull Set. Chrome

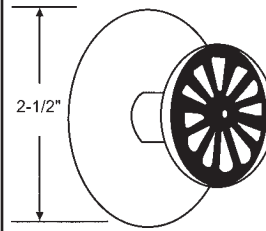

8-258

Brass
8-327 Knob, 8-321 Back Plate

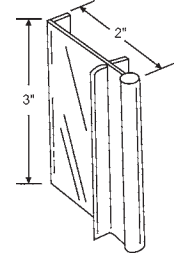

Part #	Finish
8-414	Bright Gold
8-414W	Bright White

Self-Adhesive

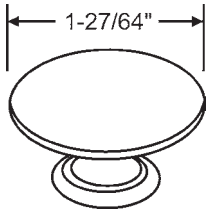

8-447

Metal, Chrome Finish

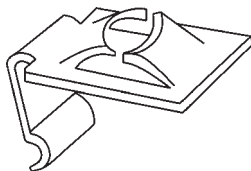

6-145

Retainer Clip
5/16" - 18 Threaded
Used with 1-138A, 1-155, 1-174,

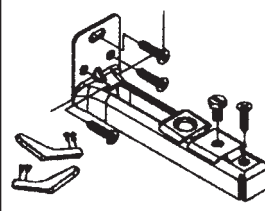

7-277

Bottomless Track Bracket

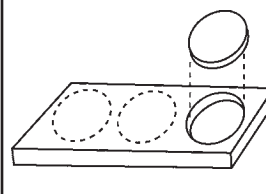

900-7429

Bi-Fold Plastic Silencer
Clear - 3 Per Pad

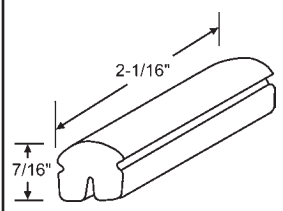

8-279

Gray Bi-Fold Track Bumper

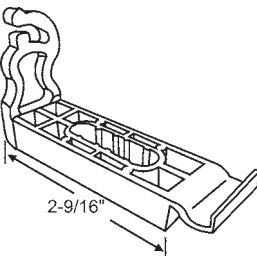

8-409

Bypass Top Guide

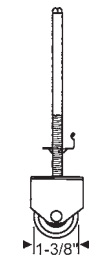

900-12272N

New Style

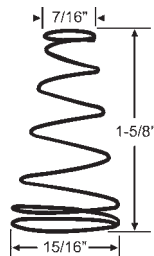

5-62

Spring

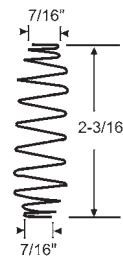

5-69

Spring



900-7431

#10 - 3/4" Pan Head Bottom
Track Screws



900-7430

#10 - 1-3/4" Pan Head Top Track Screws

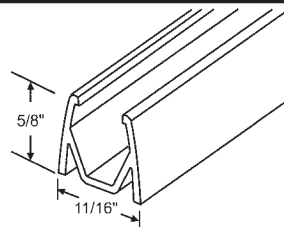

Part #	Size
900-8395	59-1/2"
900-8395-2	23-1/2"
900-8395-3	35-1/2"
900-8395-6	71-1/2"

Two-Panel Aluminum Track
Mill