

Architectural Hardware

Sash Locks

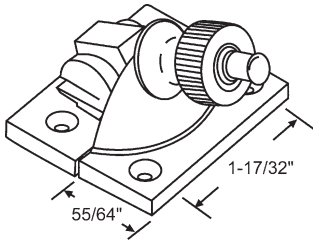

Part #	Finish
50-1096BRS	Polished Brass
50-1096CH	Chrome Plated

Spring Action. Solid Brass
Mighton

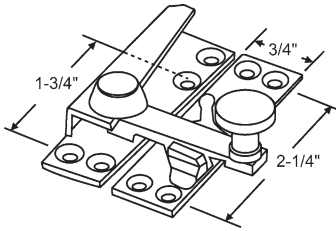

Part #	Finish
50-1097BRS	Polished Brass
50-1097CH	Chrome Plated

Solid Brass
Mighton

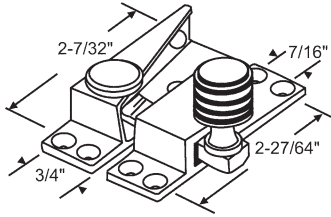

Part #	Finish
50-1098BRS	Polished Brass

Solid Brass
Mighton



50-443

The Model 50-443 is a traditional pattern sash lock. It is a beautifully elegant lock in polished brass with a burned finial. It is designed for use on large and heavy sash such as found in institutional or public buildings.

Base Dimensions: 1" X 3"
Strike Dimensions: 1/2" X 3"



50-445

The Model 50-445 sash lock is designed for use on the check rails of large or inaccessible double-hung sash which are to be locked and unlocked using a pole. The extended locking arm on this lock makes it especially suitable for the 1-3/4" and 2-1/4" thick sash usually found in large public or institutional buildings. It is hot-forged from solid brass and comes in a polished and lacquered finish.

Lock Base Dimensions and Strike Base Dimensions: 13/16" X 2-3/8"

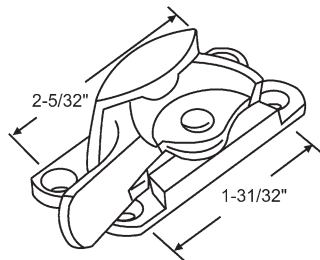

Sweep Height 11/16"

Part #	Finish
50-1099BRS	Polished Brass
50-1099CH	Chrome Plated

Solid Brass
Mighton

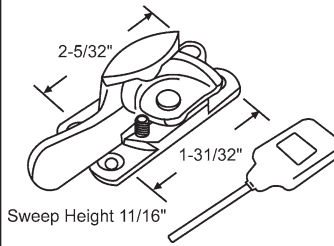

Part #	Finish
50-1100BRS	Polished Brass
50-1100CH	Chrome Plated

Solid Brass
Mighton

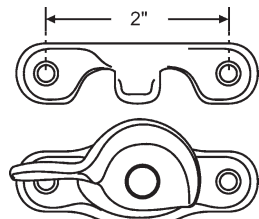

Sweep Height 5/8"

Part #	Finish
50-748	Solid Brass
50-634A	Die Cast, Brass Plated

Includes Keeper



Part #	Finish
50-440	Lacquered Polished Brass
50-440ORBZ	Oil-Rubbed Bronze
50-440PNK	Polished Nickel
50-440SNK	Satin Nickel

The Model 50-440 is a new sash lock developed to combine the best features of traditional spring action locks with an updated narrow strike. No effort has been spared to make the 50-440 the finest, most durable sash lock of its type. The quality of finish and smoothness of function are without equal. All components of this lock are hot-forged brass and stainless steel, precisely machined and hand polished.

Base Dimensions: 1" X 2-7/8"
Strike Dimensions: 7/16" X 2-7/8"

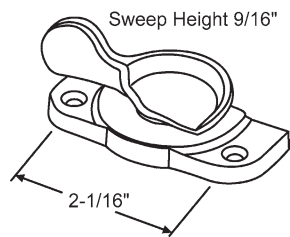

Part #	Finish
50-471-1	Bronze
50-471-5	Brass Plated
50-471-71	Oil-Rubbed Bronze

Restoration lock. Zinc die cast screws not included.

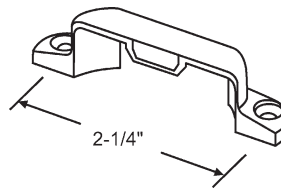

Part #	Finish
50-472-1	Bronze
50-472-5	Brass Plated
50-472-71	Oil-Rubbed Bronze

Keeper. Zinc die cast screws not included.

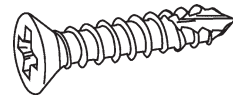

Part #	Finish
20-109-1	Bronze
20-109-5	Brass Plated
20-109-71	Oil-Rubbed Bronze

Screws for 50-471 Sash Lock and 50-472 Keeper

Lifts & Pulls

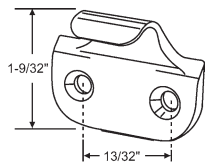

Part #	Finish
50-475-5	Brass Plated
50-475-13	Brushed Copper Nickel
50-475-71	Oil-Rubbed Bronze
50-475-72	Brushed Chrome
50-475-3	White

Includes Two Screws

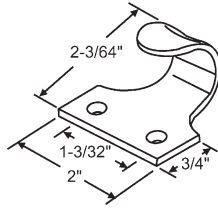

Part #	Finish
50-1101BRS	Polished Brass
50-1101CH	Chrome Plated

Solid Brass
Mighton

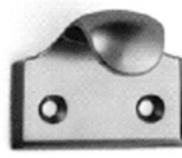

50-461

The Model 50-461 and 50-462 are hook-type sash lifts based on traditional patterns. They are used singly on sash up to 2 feet wide and in pairs on larger sash. Both lifts are solid, hot-forged brass, hand polished.

Dimensions: 3/4" w X 1-3/8" h X 1" d
Dimensions: 1" w X 1-3/4" h X 1-1/4" d

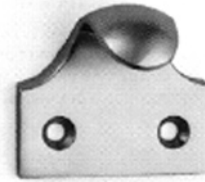

50-462

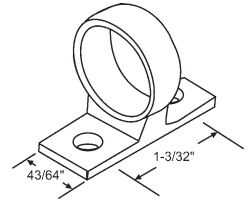

Part #	Finish
50-1102BRS	Polished Brass
50-1102CH	Chrome Plated
50-1102SCH	Satin Chrome

Ring Pull. Solid Brass
Mighton

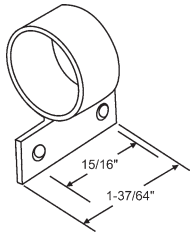

Part #	Finish
50-1103BRS	Polished Brass
50-1103CH	Chrome Plated
50-1103SCH	Satin Chrome

Ring Pull. Solid Brass
Mighton

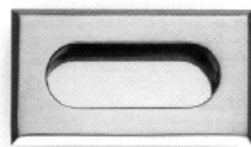

50-449

The Model 50-449 is a flush sash lift based on a traditional pattern. It is used singly on sash up to 2 feet wide and in pairs on larger sash. It is hot-forged from solid brass and hand polished. Dimensions: 1-3/4" X 3-1/8"



50-451

A solid cast brass handle type sash lift in a traditional pattern. The off-set design improves hand clearance between the handle and window stool, especially when width is limited. Used singly on sash up to 2 feet wide and in pairs on larger sash. Dimensions: 15/16" X 4-1/4"

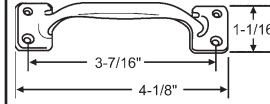

50-455-1

Solid Brass
Bright Brass Finish
with Screws

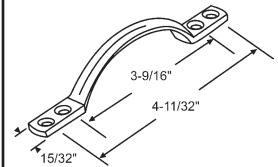

Part #	Finish
50-1104BRS	Polished Brass

D Handle w/Square Edge (shown)

Part #	Finish
50-1104CH	Chrome Plated

D Handle w/Round Edge. Solid Brass
Mighton

Brass/Steel Pulleys

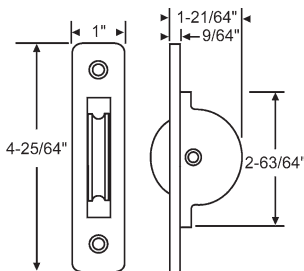

Square Corners - 2 Hole

Part #	Body Material	Body Shape	Face Plate	Wheel Type/Size	Max Load Capacity
96-MT3	Steel Body	Square Corners	Brass	1-3/4" Nylon	55 lbs.
96-MT5	Steel Body	Square Corners	Brass	1-3/4" Brass	55 lbs.
96-MT7	Steel Body	Square Corners	Plated Steel	1-3/4" Nylon	55 lbs.
96-MT9	Steel Body	Square Corners	Plated Steel	1-3/4" Brass	55 lbs.
96-MT11	Steel Body	Square Corners	Chrome Plated Brass	1-3/4" Chrome Plated Brass	110 lbs.

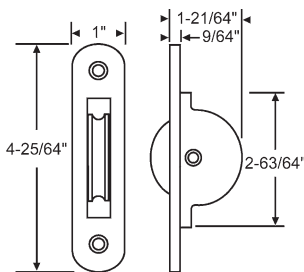

Rounded Corners - 2 Hole

Part #	Body Material	Body Shape	Face Plate	Wheel Type/Size	Max Load Capacity
96-MT4	Steel Body	Round Corners	Brass	1-3/4" Nylon	55 lbs.
96-MT6	Steel Body	Round Corners	Brass	1-3/4" Brass	55 lbs.
96-MT8	Steel Body	Round Corners	Plated Steel	1-3/4" Nylon	55 lbs.
96-MT10	Steel Body	Round Corners	Plated Steel	1-3/4" Brass	55 lbs.
96-MT12	Steel Body	Round Corners	Chrome Plated Brass	1-3/4" Chrome Plated Brass	110 lbs.

Architectural Hardware

Brass/Steel Pulleys

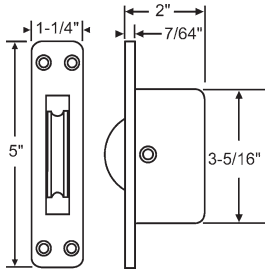

Square Corners - 4 Hole

Part #	Body Material	Body Shape	Face Plate	Wheel Type/Size	Max Load Capacity
96-MT13	Steel Body	Square Corners	Chrome Plated Brass	2" Chrome Plated Brass Ball Bearing	176 lbs.
96-MT15	Steel Body	Square Corners	Chrome Plated Brass	2-1/4" Chrome Plated Brass Ball Bearing	176 lbs.
96-MT17	Steel Body	Square Corners	Brass	2" Brass Ball Bearing	176 lbs.
96-MT19	Steel Body	Square Corners	Brass	2-1/4" Brass Ball Bearing	176 lbs.
96-MT22	Steel Body	Square Corners	Stainless Steel	2" Stainless Steel	55 lbs.

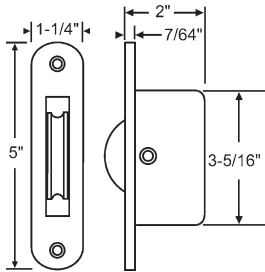

Round Corners - 2 Hole

Part #	Body Material	Body Shape	Face Plate	Wheel Type/Size	Max Load Capacity
96-MT14	Steel Body	Round Corners	Chrome Plated Brass	2" Chrome Plated Brass Ball Bearing	176 lbs.
96-MT16	Steel Body	Round Corners	Chrome Plated Brass	2-1/4" Chrome Plated Brass Ball Bearing	176 lbs.
96-MT18	Steel Body	Round Corners	Brass	2" Brass Ball Bearing	176 lbs.
96-MT20	Steel Body	Round Corners	Brass	2-1/4" Brass Ball Bearing	176 lbs.

Polysash Pulleys

Sash Chain

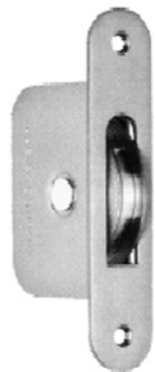

96-P1

The Model 96-P1 is a larger, redesigned version of our popular ball bearing sash pulley. It has been designed to meet the needs of custom high-end window fabricators building large and heavy sash. The Model 96-P1 features a hot forged solid brass 1-1/8" x 5-7/16" radius end faceplate, 2-1/2" solid brass precision turned pulley wheel for chain or cord, and a sealed ball-bearing for many years of smooth operation. The standard finish is satin lacquered. Faceplate Dimensions: 1-1/8" x 5-7/16" Housing Dimensions: 2-3/16" x 3-1/4" x 3/4"

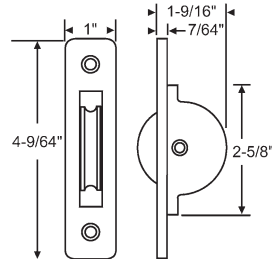

96-MT1

Polyethylene Body, Square Corners, 1-3/4" Nylon Wheel. 2 Holes
Max Load Capacity = 20 lbs.

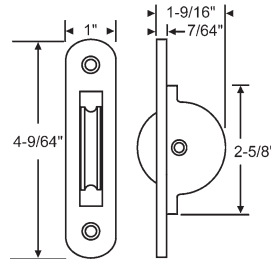

96-MT2

Polyethylene Body, Round Corners, 1-3/4" Nylon Wheel. 2 Holes
Max Load Capacity = 20 lbs.

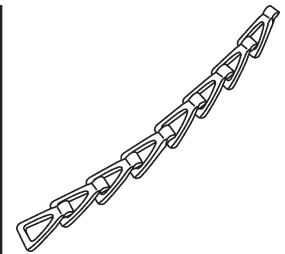

Part #	Type
96-800	Stainless Steel
96-801	Brass

Load Limit 250 lbs.
Linked Type. 50' Rolls

Mighton



Part #	Weight
96-805	Up to 70 lbs.
96-806	Up to 165 lbs.

Steel Chain w/Copper Rivets
Only. Order Connectors Separately. 50' Rolls

Mighton

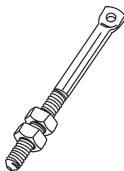

96-807

Weight Connector for Riveted Chain

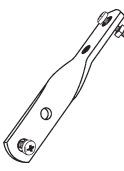

96-808

Sash Connector for Riveted Chain



96-708

Spiral Clip. Fits into 7/8" diameter hole bored into side of sash stile. Threads onto the end of sash chain. Plated steel.

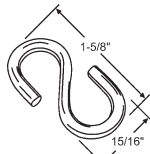

96-709

S Hook. Used for attaching chain to stackable counter weights. Plated steel

Sash Chain is preferred over sash cord in instances where greater longevity is required such as in high quality residential construction, restoration work, and public buildings. Our solid bronze, solid brass, and stainless steel sash chains will give many years of reliable service. The chain types and sizes shown below are held in stock in boxes of 100 feet.



96-701

#45 Solid Bronze
Load Limit 160 lbs.



96-702

#25 Solid Bronze
Load Limit 80 lbs.



96-703

#3 Solid Brass
Load Limit 100 lbs.



96-706

#35 Stainless Steel
Load Limit 225 lbs.

Sash Cords

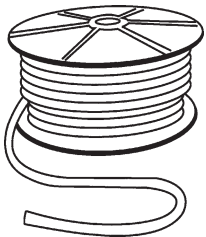

Our pre-stretched, premium waxed cotton sash cord has an inner synthetic-stranded cord for increased strength and flexibility. The outer covering of plaited waxed and polished premium grade cotton is designed specifically for use with pulley systems and will give many years of smooth and trouble-free performance. Both come in 100' hanks.

Part #	Length
96-802	65' Roll
96-803	164' Roll
96-804	328' Roll

Load Limit 220 lbs.
1/4" Nylon Cord

Mighton



96-704
#8 (1/4")

Load Limit 100 lbs.



96-705
#10 (5/16")

Load Limit 200 lbs.

Sash Counterweights



Our 96 series stackable cast iron counterweights are designed to economically facilitate the balancing of sash in weight and pulley windows. The 1/2" through-hole permits their use with either rope or chain. The square and radius cross-section provides more weight per inch than conventional round weights, essential when dealing with heavier glazings or insulating glass. The 1 lb., 3 lbs., and 5 lbs. sizes permit flexibility and precision in attaining a proper balance. They are suitable for 1-3/4" or larger sash in either new construction or retrofit.

Part #	Weight	Height
96-700-5	5 lbs.	7-7/8"
96-700-3	3 lbs.	5-1/8"
96-700-1	1 lb.	2-3/8"

Accessories



Part #	Finish
19-321	Solid Brass
19-321ORBZ	Oil Rubbed Bronze

Stop Bead Adjuster

A solid brass stop bead adjuster for mounting removable window stops. The slotted screw hole permits 1/8" of lateral adjustment. They are supplied in boxes of 50 pieces with accompanying #8 x 1" wood screws.

Spring Bolts

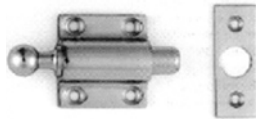

19-317

The Model 19-317 is a surface mounted window spring bolt designed for holding a vertical or horizontal sliding sash in either an open or closed position. The spring plunger may be locked into its fully retracted position by a simple rotation of the spherical knob. The window spring bolt is especially suited for retrofitting to older windows lacking balance systems or to any sash requiring a multi-position lock. The Model 19-317 is precision extruded and machined from solid brass and hand polished. Three strike plates are furnished with each lock. Base Dimensions: 1-1/8" x 1-1/4" Strike Dimensions: 5/8" x 1-7/16"



19-318

The Model 19-318 is a solid brass window spring bolt designed for installation in the wood stile of a vertically sliding sash. This type of hardware is commonly used in pairs on light weight, single hung sash in lieu of a balance system or sash lock, and is designed to be press-fit into a 3/8" diameter hole bored through the sash stile. A hole to accept the spring plunger is then bored in the window jamb to hold the sash at any desired height. The Model 19-318 is precision turned solid brass with a stainless steel spring. Housing Dimensions: 1-7/8" x 3/8" Overall Length: 3-3/8"

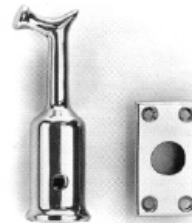

39-572 39-573

The Model 39-572 pole hook and Model 39-573 pole hook socket are intended to facilitate the operation of large or inaccessible double-hung windows. The pole hook is designed to be mounted on the end of a wooden operating pole of an appropriate length. The 39-573 pole socket is easily mounted in the sash rail, requiring only the boring of a 1" diameter hole. Both items are solid cast brass with a polished and lacquered finish. Model 39-572 Dimensions: 4"L x 7/8" I.D. Model 39-573 Dimensions: 1-1/4" x 2-1/4"

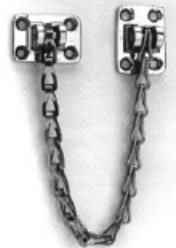

19-320

The Model 19-320 transom chain is designed to limit the opening of transom sash or other bottom hinged windows. The chain brackets are solid, polished and lacquered brass. The 12" chain is solid bronze. Base Dimensions: 1-3/16" x 1" x 11/16"

Vent Locks

Key Operated Vent Lock

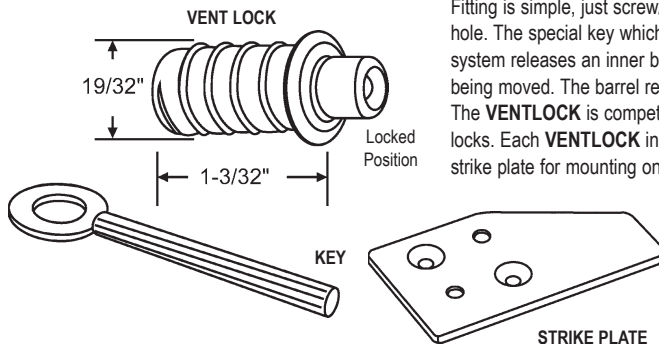

The new innovative VENTLOCK acts as a major deterrent to snatch thieves who spot what they consider is an easily opened window. Fitting is simple, just screw/insert it into the appropriate diameter drill hole. The special key which is supplied as part of the VENTLOCK system releases an inner barrel which prevents the window from being moved. The barrel revolves freely preventing it from being cut. The VENTLOCK is competitively priced against existing window locks. Each VENTLOCK includes a steel operation key and a brass strike plate for mounting on the lower sash check rail.

Part #	Finish
50-446	Solid Brass
50-446CH	Chrome

Vent Lock with Key and Strike

Mighton

MEETS: ASTM F 2090 Standard Specification for Window Fall Prevention Devices With Emergency Escape (Egress) Release Mechanisms

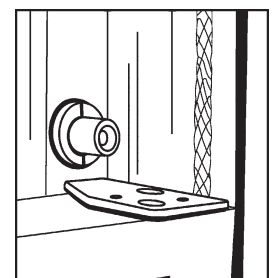

Open Position Shown

Architectural Hardware

Vent Locks and Accessories

Push and Twist Keyless Vent Lock

Finger Operated: Push and Turn with Your Finger

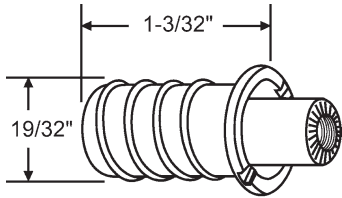

The natural companion product to Key Operated Ventlocks. Use where Fire Egress may be of concern or above ground floor level.

Part #	Finish
50-1201CH	Chrome
50-1201BRS	Solid Brass

Push and Twist Ventlock. Solid Brass

Mighton

MEETS: ASTM F 2090 Standard Specification for Window Fall Prevention Devices With Emergency Escape (Egress) Release Mechanisms

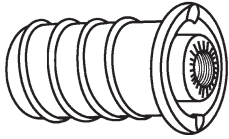

Brass Vent Lock for PVC Vinyl Windows

Ventlock is Quick and Easy to Install

1. Drill Hole
2. Insert Ventlock
3. Drill Rivet Holes
4. POP Rivet Ventlock into the Sash
5. Conceal Rivets with Self Adhesive Trims

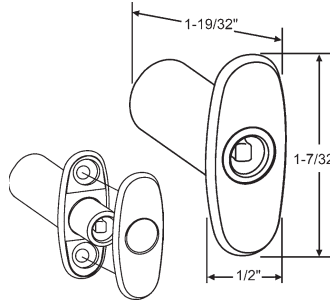

50-1106

Vent Lock for PVC Vinyl Windows

Includes Key

Mighton

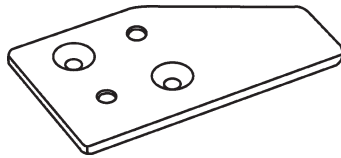
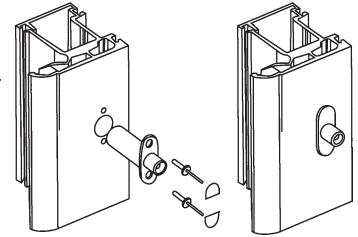

Part #	Finish
50-1105BRS	Solid Brass
50-1105CH	Chrome
50-1105SCH	Satin Chrome

Vent Lock Strike Plate Only

Mighton

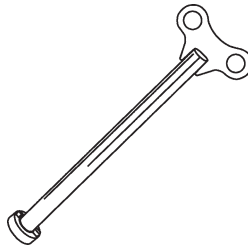

59-73M

Ventlock Hand Tool

Mighton

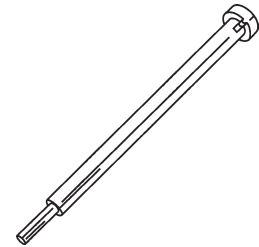

59-73

Ventlock Tool for Cordless Drill

Mighton

Casement Hardware



Part #	Hand
34-79RH	Shown
34-79LH	Opposite

The Model 34-79 casement fastener is hot-forged solid brass and hand polished. Available either right or left-handed.

Base Dimensions:

11-16" X 2-3/8"

Handle: 2"

Overall Depth: 1-1/4"

Strike sold separately.



Part #	Hand
34-77RH	Shown
34-77LH	Opposite

The newly redesigned Model 34-77 casement fastener is hot-forged from solid brass and hand polished. Available either right or left-handed.

Base Dimensions: 11/16" X 2-3/8"

Handle: 3-1/2"

Overall Depth: 1-7/8"

Strike sold separately.



50-453



50-454



50-463



50-464

Strike Plates for Casement Fasteners

Part #	Description
50-453	Mortise Strike
50-454	Surface Strike
50-463	Rim Strike
50-464	Angle Strike (for use on windows with compression weatherstripping)

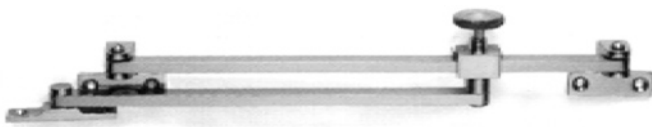

29-204

(Out-Swing Shown/Brackets Invert for In-Swing)

The model 29-204 is a 12-1/2" solid polished brass slide-bar type adjuster for wood in-swing or out-swing windows. Based on a traditional pattern, this beautifully made casement adjuster is designed so as not to interfere with hinged or rolling interior screens whether in the open or closed position. For universal (left or right hand) operation.

Overall Length: 12-1/2"

Overall Height: 2-3/8"

Overall Depth: 1-3/8"

Casement Hardware



29-205

The Model 29-205 sliding rod casement adjuster is a highly finished version of a traditional American pattern. It is designed for use on out-swing hinged windows. The 29-205 is hot-forged and precision machined from solid brass and hand polished. Base Dimensions: 15/16" X 2-3/8"
Overall Length: 13-1/2"
Overall Height: 2"



29-206

The Model 29-206 telescopic friction casement stay is a highly finished, heavy-duty version of a pattern common to early 20th century casement windows. It is designed for installation on all types of out-swinging hinged sash. The degree of friction may be adjusted by means of the large brass nut at the barrel end. The 29-206 is offered in solid brass, with a hand polished and lacquered finish.

Screen Hardware



Part #	Finish
17-155	Polished Lacquered
17-155SNK	Satin Nickel

The newly redesigned Model 17-155 is a solid brass screen or storm door latch set. The lock case, escutcheon plate and strike are hot-forged and precision machined for smooth operation. The spring mechanism is stainless steel. The lever and threaded spindle are hot-forged in one piece for added strength, and the knob is turned from brass bar stock. The latch set is supplied with an angle strike and a rim strike. Backset is 1-9/16". The threaded spindle allows easy adjustment for door thicknesses of 1-1/8" to 1-3/4". Thinner doors can be accommodated by cutting the spindle. Dimensions: Case 2-1/4" X 2"
Back Plate 1-1/4" X 4" Knob 1-5/8" dia.
Overall Depth: Lever side 1-7/16" Knob side 1-1/2"

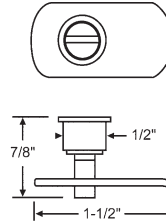

19-319

The Model 19-319 cam fastener is a solid brass assembly designed to fasten wood storm or screen inserts into a combination door or other frame. The standard finish is unlacquered.



Part #	Size
69-29BR	24" x 100'
69-65BR	36" x 100'
69-77BR	48" x 100'

Bronze Insect Screening

Our heavy-duty solid bronze insect screening is designed for fabrication of high quality window screens and screen doors. It is woven of .011" solid bronze wire into an 18 X 14 mesh.

Parting Bead

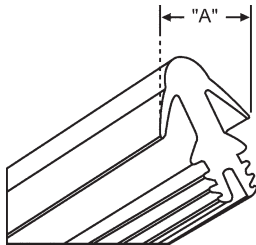

One-piece parting bead that weather-strips both top and bottom sashes. The fins are almost undetectable when installed. Will never rot. Made from UV - stabilized PVC. Simple to install. Can be used on new construction or restoration. Takes the rattle out of old sash windows. Severe weatherproof rating.

Part #	Color	Length	"A"
63-330	White	94-1/2"	15/32"
63-332	White	94-1/2"	5/8"
63-333	Brown	94-1/2"	5/8"

Mighton

Brush Seal

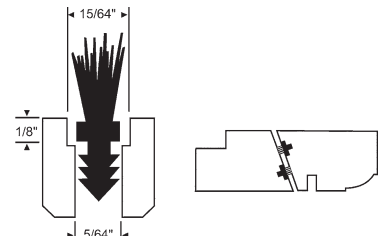
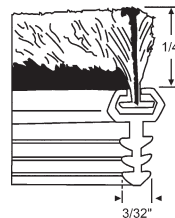

Part #	Color	Length
63-336	White	86-3/4"
63-337	Black	86-3/4"

Mighton

Simple to Install. Low friction pile with single polypropylene fin which provides 50% easier sash movement while providing maximum resistance to air and water penetration. Long life performance.

Weatherstrip

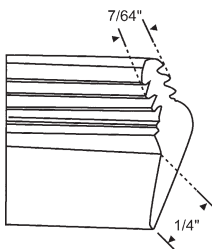

Part #	Finish	Length
63-334	White	94-1/2"
63-335	Brown	94-1/2"

Standard Weatherstrip

Mighton

Mini Groover

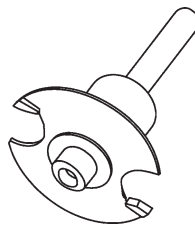

59-74

Mini Groover for Standard Weatherstrip 63-334 & 63-335

Mighton

Hinges

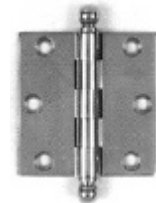

Part #	Size
19-322	3" x 3"
19-323	3-1/2" x 3-1/2"
19-324	4" x 4"

Our 19 series polished brass butt hinges are designed for use on wood casement windows and doors. The hinge body is precision extruded brass, .125" thick, and has removable ball tips. The finish is hand polished and lacquered. Sold in pairs.