

Sash Support Systems

96CQ Series Quick Tilt Constant Force Balance Accessories

The old style quick tilt constant force balance assemblies are no longer available. They are replaced with quick tilt NC assemblies. The old style quick tilt carriers use the "T" head pivot bars (see below), which will also need to be replaced when converting to the new style quick tilt NC system. The replacement assemblies take the round head pivot bar (see below). When ordering the replacement balance assemblies, identify the carrier size and the weight of the sash. Then, select the corresponding quick tilt NC balance assembly from chart shown on page 94.

Old Style

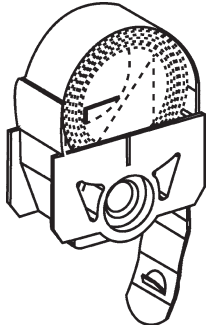

Tamper Lock

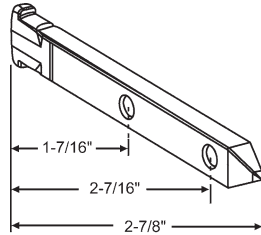
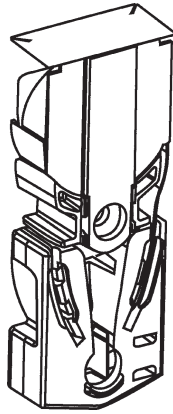

96CQ-20

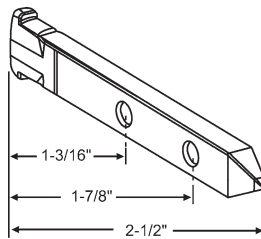

96CQ-22

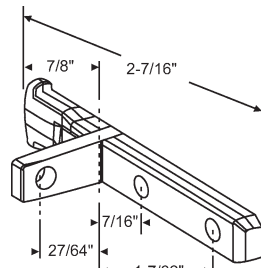

96CQ-26

T-Head Pivot Bars
Use with Old Style system
No longer available. Use: 96CQ-27

New Style

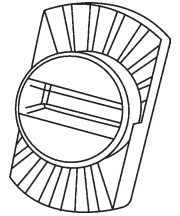
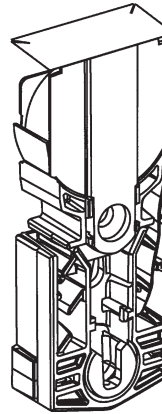

96CQ-18
Friction Adjuster

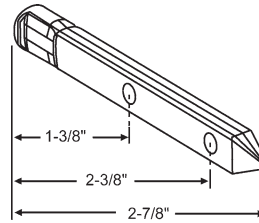

96CQ-24

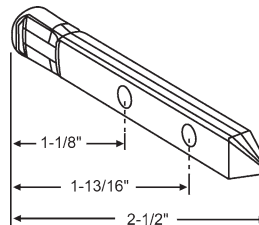

96CQ-23

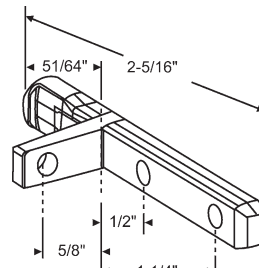

96CQ-27

Round-Head Pivot Bars
Use when converting to quick tilt NC.

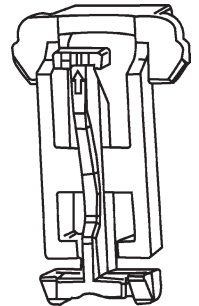

96CQ-17
Tamper Lock

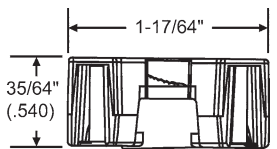
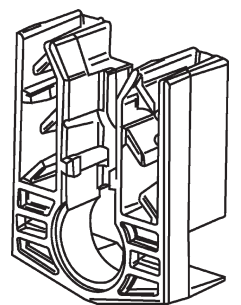

.540 Carrier

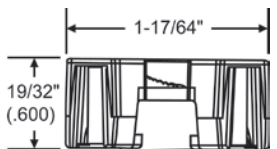

.600 Carrier

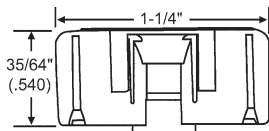

.540 Carrier

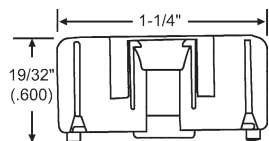

.600 Carrier

TOLL FREE: 800-352-0800

2011 PGI©

strybuc
FINE LITERATURE

Sash Support Systems

96CQ Series Quick Tilt Constant Force Balances

Coil balance assemblies are listed by carrier thickness. These carriers use a round head pivot bar. Quick Tilt coil balances are sold as a complete set only.

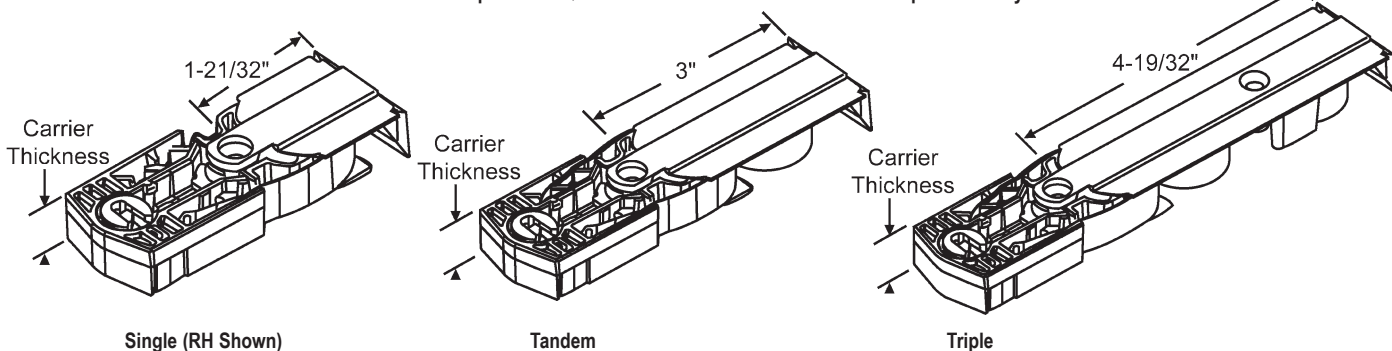

Balance Assembly with .540 Carrier Thickness	Balance Assembly with .600 Carrier Thickness	Weight	Coil
96CQ-30RH	96CQ-31RH	3 lb. Cover Assy. RH	SINGLE
96CQ-32RH	96CQ-33RH	4 lb. Cover Assy. RH	SINGLE
96CQ-34RH	96CQ-35RH	5 lb. Cover Assy. RH	SINGLE
96CQ-36RH	96CQ-37RH	6 lb. Cover Assy. RH	SINGLE
96CQ-38RH	96CQ-39RH	7 lb. Cover Assy. RH	SINGLE
96CQ-40RH	96CQ-41RH	8 lb. Cover Assy. RH	SINGLE
96CQ-42RH	96CQ-43RH	9 lb. Cover Assy. RH	SINGLE
96CQ-30LH	96CQ-31LH	3 lb. Cover Assy. LH	SINGLE
96CQ-32LH	96CQ-33LH	4 lb. Cover Assy. LH	SINGLE
96CQ-34LH	96CQ-35LH	5 lb. Cover Assy. LH	SINGLE
96CQ-36LH	96CQ-37LH	6 lb. Cover Assy. LH	SINGLE
96CQ-38LH	96CQ-39LH	7 lb. Cover Assy. LH	SINGLE
96CQ-40LH	96CQ-41LH	8 lb. Cover Assy. LH	SINGLE
96CQ-42LH	96CQ-43LH	9 lb. Cover Assy. LH	SINGLE
96CQ-44	96CQ-45	8 lb. Cover Assy.	TANDEM
96CQ-46	96CQ-47	9 lb. Cover Assy.	TANDEM
96CQ-48	96CQ-49	10 lb. Cover Assy.	TANDEM
96CQ-50	96CQ-51	11 lb. Cover Assy.	TANDEM
96CQ-52	96CQ-53	12 lb. Cover Assy.	TANDEM
96CQ-54	96CQ-55	13 lb. Cover Assy.	TANDEM
96CQ-56	96CQ-57	14 lb. Cover Assy.	TANDEM
96CQ-58	96CQ-59	15 lb. Cover Assy.	TANDEM
96CQ-60	96CQ-61	16 lb. Cover Assy.	TANDEM
96CQ-62	96CQ-63	17 lb. Cover Assy.	TANDEM
96CQ-64	96CQ-65	18 lb. Cover Assy.	TANDEM
96CQ-66	96CQ-67	19 lb. Cover Assy.	TANDEM
96CQ-68	96CQ-69	20 lb. Cover Assy.	TANDEM
96CQ-70	96CQ-71	21 lb. Cover Assy.	TRIPLE
96CQ-72	96CQ-73	22 lb. Cover Assy.	TRIPLE
96CQ-74	96CQ-75	23 lb. Cover Assy.	TRIPLE
96CQ-76	96CQ-77	24 lb. Cover Assy.	TRIPLE
96CQ-78	96CQ-79	25 lb. Cover Assy.	TRIPLE
96CQ-80	96CQ-81	26 lb. Cover Assy.	TRIPLE

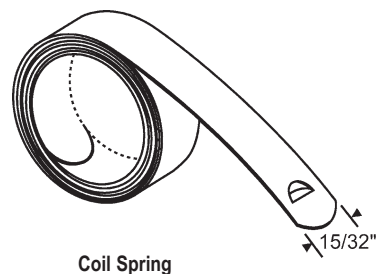

Coil Spring

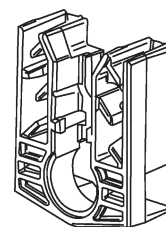

Carrier Body

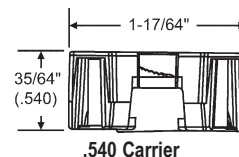

.540 Carrier

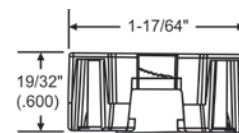

.600 Carrier

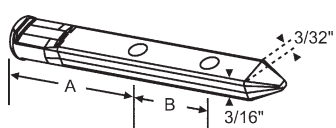

Round Head Pivot Bar

Part #	A	B	Overall Length
96CQ-23	1-5/32"	1-53/64"	2-1/2"
96CQ-24	1-3/8"	2-3/8"	2-7/8"

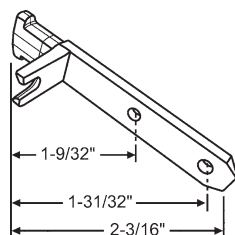

96CQ-28
Quick Tilt Pivot Bar

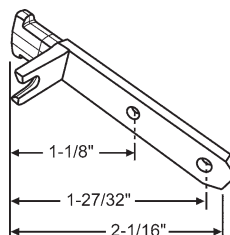

96CQ-29
Quick Tilt Pivot Bar

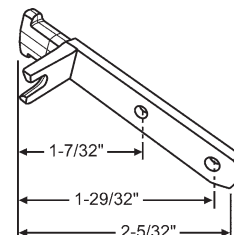

96CQ-30
Quick Tilt Pivot Bar