

# Window Replacement Hardware

## Top Hung Hinge Assembly

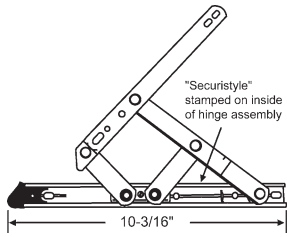

**28-93-10**

10" Storm Hinge (Pair). Stack Height 5/8".  
RH Shown. Stainless Steel  
Securistyle

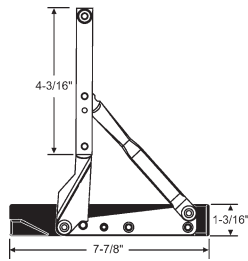

**28-135C**

Friction Hinge Set. RH Shown.  
Stainless Steel.  
Certainteed Insulate

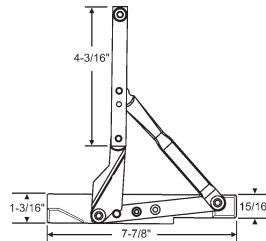

Part #	Hand
28-135AR	Shown
28-135AL	Opposite

Friction Hinge. Stainless Steel.  
Andersen Renewal

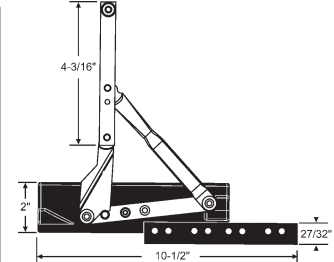

Part #	Hand
28-135ML	Shown
28-135MR	Opposite

Stainless Steel.  
Milgard

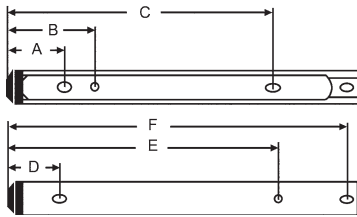

Part No.	Size	Recommended Maximum Sash		
		Width	Height	Weight in lbs.
900-21941	10"	47-1/4"	17-11/16"	35
900-21941-16	16"	47-1/4"	29-1/2"	48.5

Size	Fixing Hole Details in Millimeters					
	A	B	C	D	E	F
10"	35	62	193	30.8	217.6	255
16"	36.1	139	271.9	30.8	309	407.2

G-U Hardware

## Miscellaneous Operator Hardware

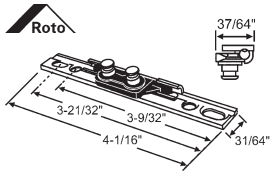

**39-692**

Surface Mount Awning Bracket  
Assembly.

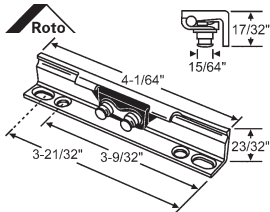

**39-691**

Face Mount Awning Bracket  
Assembly.

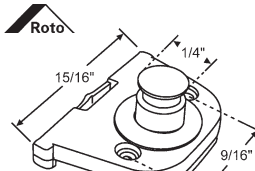

**39-753**

Slider for 38-21 Track

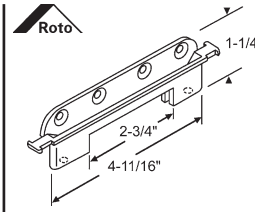

**39-351**

Use: 39-614

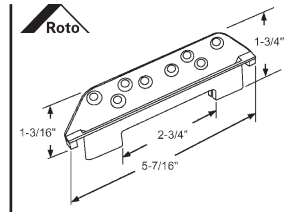

**39-614**

Die Cast Witteman Counterpart  
Spacer. Replaces Old  
Spacer 39-351

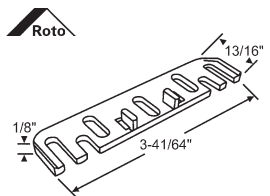

**39-665**

Black Nylon Spacer for Pro-Drive  
Operator

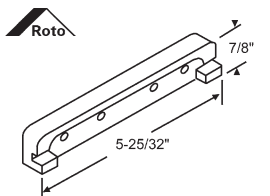

Part #	Color
39-350	Black
39-350W	White

Plastic Support

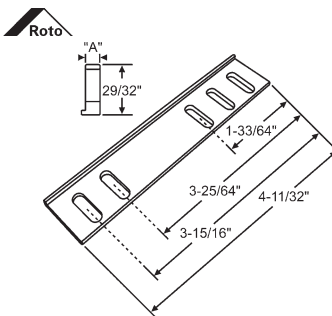

Part #	"A"
39-687	3/32"
39-687A	11/64"
39-687B	1/4"
39-687C	21/64"
39-687D	13/32"

Operator Bottom Spacer.  
Black

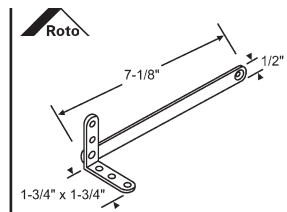

**39-352**

Connecting Arm with Bracket for  
36-333 and 36-334.  
Zinc Dichromate

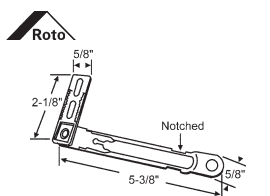

**39-497**

Stainless Steel Connect Arm with  
Die Cast Bracket.

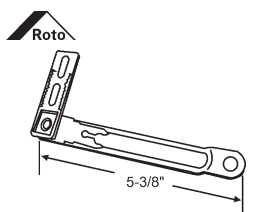

**39-571**

Stainless Steel Connect Arm with  
Die Cast Bracket. **No Longer  
Available.** Use: 39-497

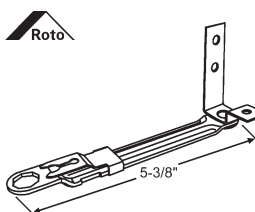

**39-794**

Stainless Steel Connect  
Arm Assembly with Stainless  
Steel Bracket

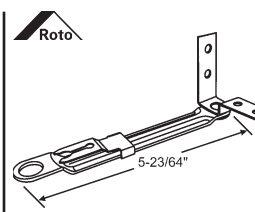

**39-817**

Stainless Steel Connect  
Arm Assembly with Steel  
Bracket

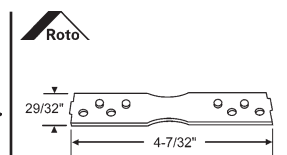

**39-602**

4-1/8" Black Top Spacer  
3.5mm Thick x 22.5mm High

# Window Replacement Hardware

## Miscellaneous

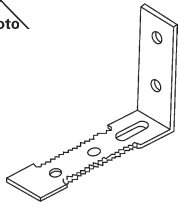

**39-575**

Sash Adapter Bracket for Casement Window. Stainless Steel

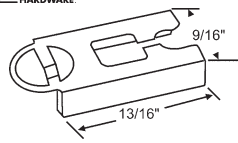

**39-207**

Detach Clip Bracket

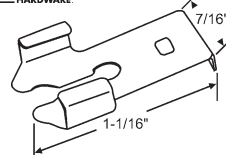

**39-323**

Stainless Steel Detach Clip

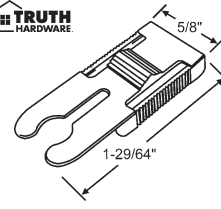

**39-758**

Black Plastic Detach Clip

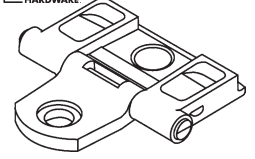

**39-379**

Pivot Shoe Assembly

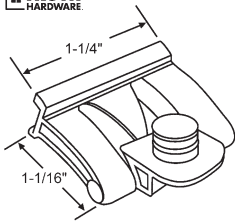

**39-441**

Pivot Slide Assembly  
Black, Plastic

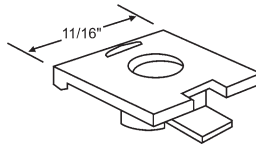

**39-469**

Black Casement Slider

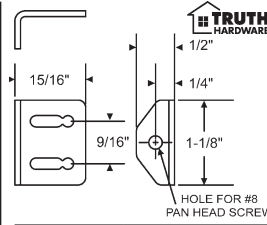

Part #	Finish
39-738-3	White
39-738-8	Chestnut Bronze

Stabilizing Tab. Includes 2 screws for attachment to operator.

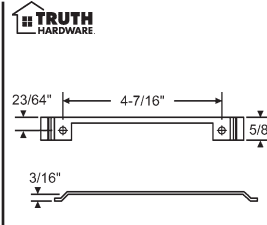

**39-763**

Maxim® Dual Arm Operator Back Plate

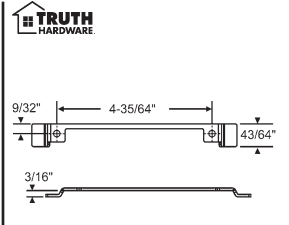

**39-733**

Encore™ Dyad Operator Back Plate

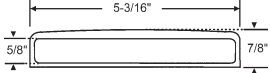

**39-417**

Gasket for Maxim Operator

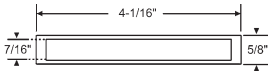

**39-512**

Gasket for Traditional Operator

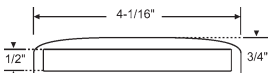

**39-511**

Gasket for Ellipse Operator

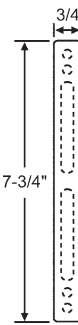

**39-44**

Operator Gasket

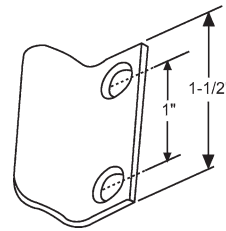

Part #	Finish
39-112	E-Gard Finish
39-112-3	White

Side Jam Snubber

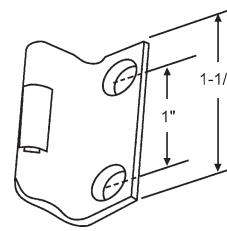

Part #	Finish
39-114-9	Beige
39-114-14	Cocoa Brown
39-114-23	Sandstone

Side Jam Snubber with Vinyl Insert

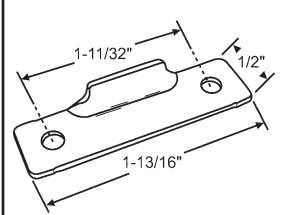

Part #	Finish
39-303	E-Gard

Concealed Snubber

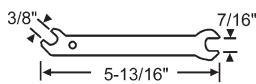

**39-462**

Combo Stud Wrench

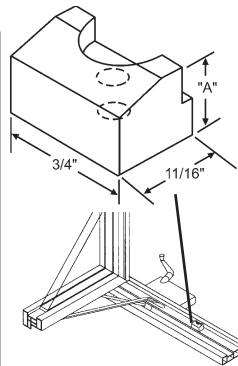

Part #	Description	"A"
39-519	Clear Plastic	7/16"
39-519W	White	7/16"
39-520	Clear Plastic	1/2"
39-437	White	1/2"

Casement Ramp  
Acorn

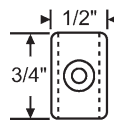

**39-611**

Slide Block  
White  
Silverline

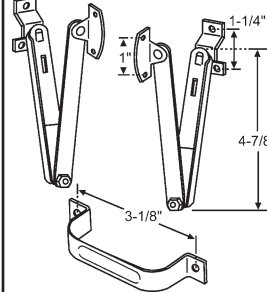

**900-15453**

Storm Window Adjuster - Pair  
Locks window securely when closed.

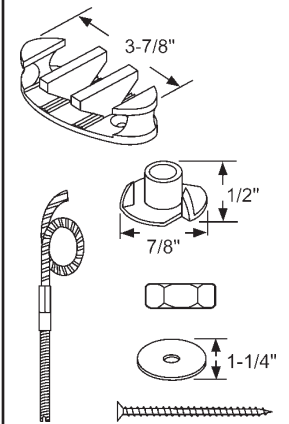

**900-22378**

Window Cable Support Kit for Bay Window

# Window Replacement Hardware

## Finger Latches & Slide Bolts

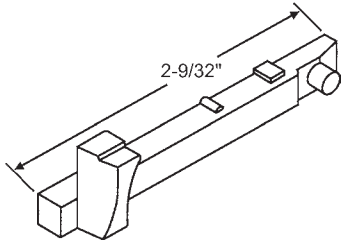

Part #	Hand
900-5736	Shown
900-5735	Opposite

Slide Bolt, Nylon  
Newell

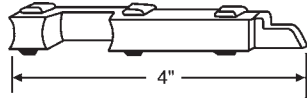

**46-15A**  
Slide Bolt Set (LH/RH)  
Nylon

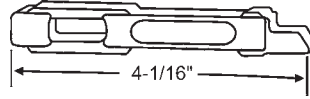

Part #	Finish
46-2A	Mill
46-2WA	White
46-2BA	Brown

Die Cast Set (LH/RH)  
Capitol

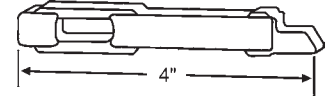

**46-23A**  
Nylon Set (LH/RH)

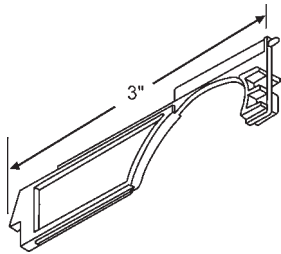

**46-30**  
Die Cast

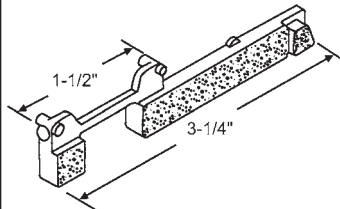

Part #	Hand
46-32	Shown
46-31	Opposite

Die Cast

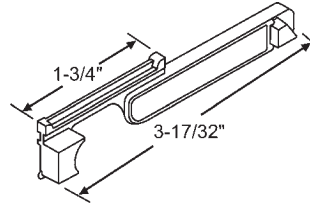

Part #	Hand
46-39	Shown
46-40	Opposite

Die Cast

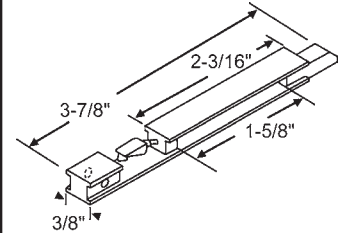

**46-50A**  
LH/RH Slide Bolt, Sold in Set (RH Shown)  
White Nylon

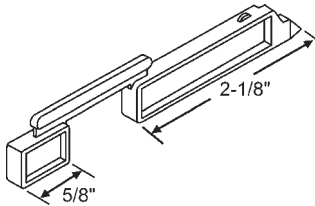

Part #	Hand
46-52	Shown
46-53	Opposite

Natural Nylon

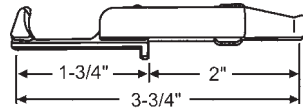

Part #	Hand
900-18534LH	Shown
900-18534RH	Opposite

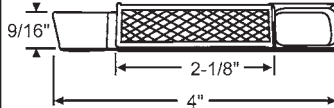

Part #	Hand
900-13501LH	Shown
900-13501RH	Opposite

Bright Zinc, Die Cast

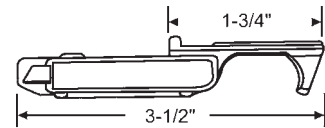

Part #	Hand
900-11890	Shown
900-11891	Opposite

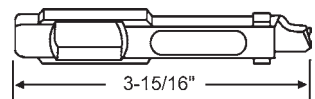

Part #	Hand
900-11877	Shown
900-11878	Opposite

Die Cast  
Seasonal

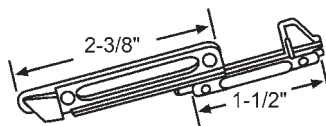

Part #	Hand
900-22011LH	Shown
900-22011RH	Opposite

Die Cast

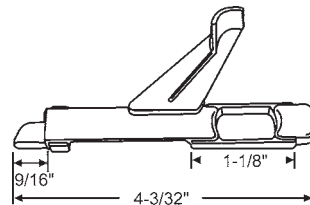

Part #	Hand
900-9297	Shown
900-9298	Opposite

Capitol

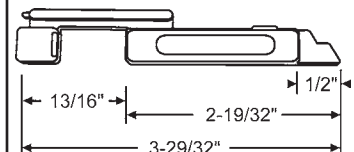

**900-12146A**  
Nylon Set (LH/RH)

# Window Replacement Hardware

## Finger Latches & Slide Bolts

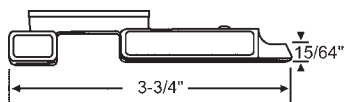

Part #	Hand
46-164LH	Opposite
46-164RH	Shown

White Nylon

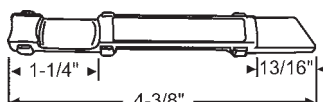

Part #	Hand
900-18849	Shown
900-18850	Opposite

Die Cast

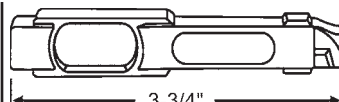

Part #	Hand
900-10187LH	Opposite
900-10187RH	Shown

Die Cast  
Seasonall

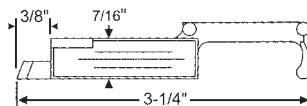

Part #	Hand
900-18535LH	Shown
900-18535RH	Opposite

Die Cast

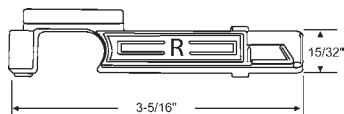

Part #	Hand
46-4	Shown
46-5	Opposite

Die Cast

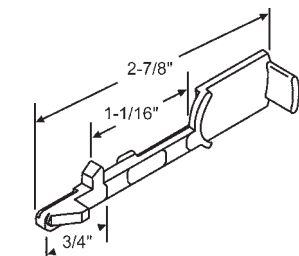

Part #	Hand
900-445LH	Shown
900-445RH	Opposite

Die Cast

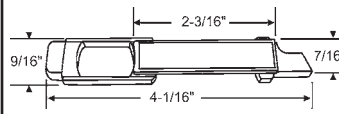

**900-17495**  
Die Cast Set (RH/LH) with Springs  
RH Shown  
Traco

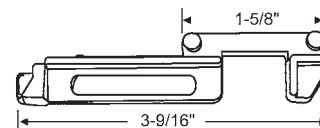

Part #	Hand
900-12610LH	Shown
900-12610RH	Opposite

Die Cast

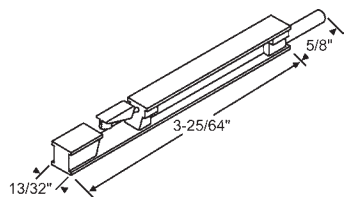

Part #	Finish
900-1725	Natural Nylon

Nylon, Non-Hand

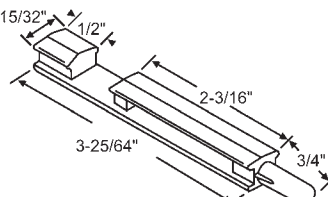

Part #	Finish
46-280W	White
46-280BG	Beige

Nylon, Non-Hand

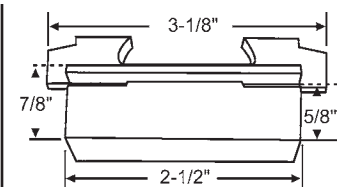

**46-122**  
Black, Plastic

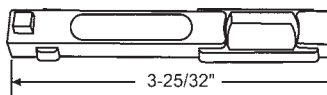

Part #	Hand
46-118	Shown
46-119	Opposite

Die Cast

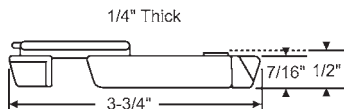

Part #	Hand
900-1655	Shown
900-1656	Opposite

Nylon

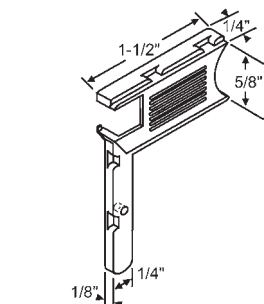

Part #	Hand
900-9229LH	Shown
900-9229RH	Opposite

Die Cast

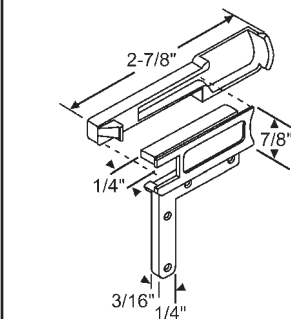

**46-33A**  
Die Cast  
Sold in Sets Only

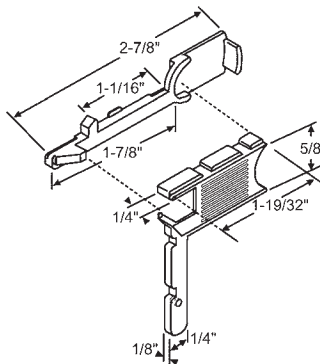

**900-1831BA**  
Plastic Slide Bolt Black  
Sold in Sets Only

# Window Replacement Hardware

## Finger Latches & Slide Bolts

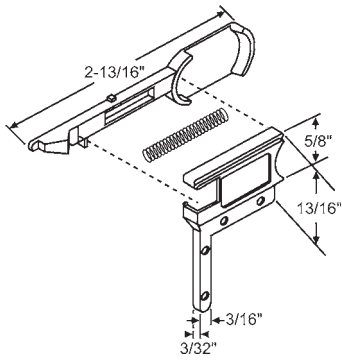

Part #	Hand
900-18624RHN	Shown
900-18624LHN	Opposite

Slide Bolt

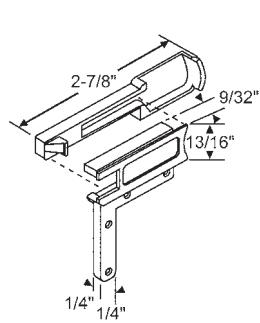

**46-35A**  
Finger Latch Set (LH/RH)  
Die Cast

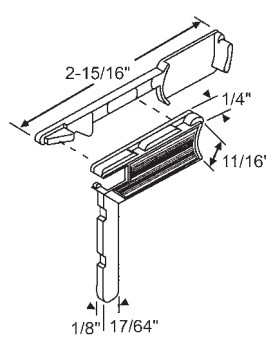

Part #	Hand
46-37	Shown
46-38	Opposite

Die Cast

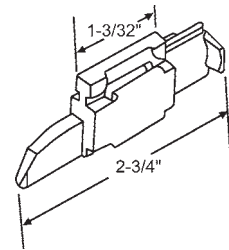

Part #	Hand
900-13382LH	Shown
900-13382RH	Opposite

Die Cast

## Slide Bolt Accessories

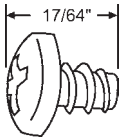

**900-13382S**

Screw for 900-13382LH/RH

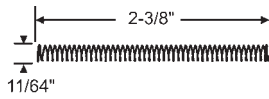

**900-13382SP**

Spring for 900-13382LH/RH

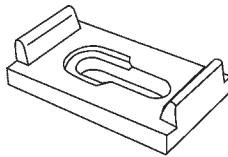

**900-13382L**

Limit Stop for 900-13382LH &  
900-13382RH. Black

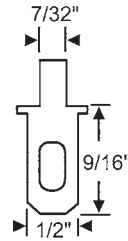

**900-13382R**

Spring Retainer  
Zinc

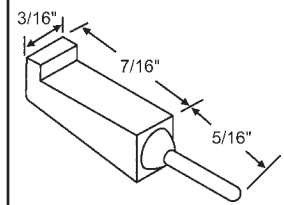

**900-5732**

Nylon Spring Insert for 900-5735  
Slide Bolts/Finger Latch

## Slide Bolt Springs

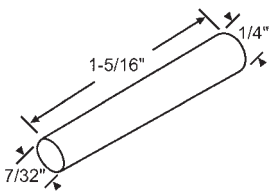

**900-17455**

Storm Slide Bolt Extension  
Nylon

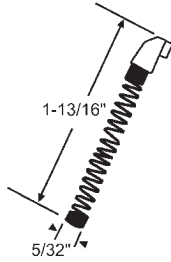

**46-10**

Plastic Tip

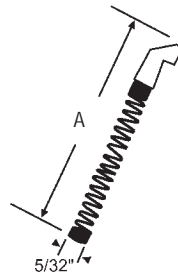

Part #	A
46-28	1-63/64
46-28S	1-5/16

Plastic Tip

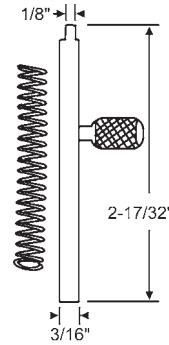

**900-9573**

Latch Pin Bar with Spring

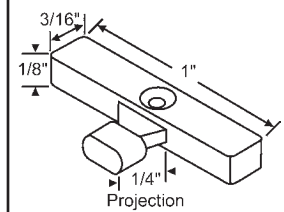

**900-11894**

Anti-Bow Pin  
Die Cast

## Anti-Bow Pin

## Insert Clips

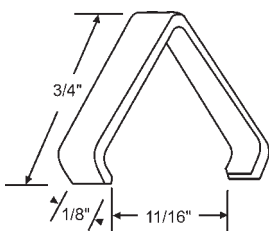

**46-1**

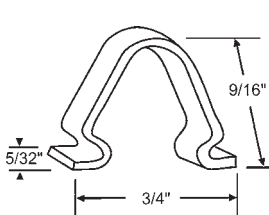

**46-6**

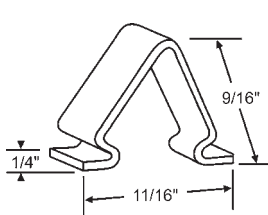

**46-22**

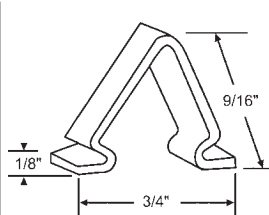

**46-126**

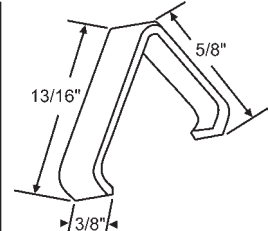

**46-218**

# Window Replacement Hardware

## Corner Keys

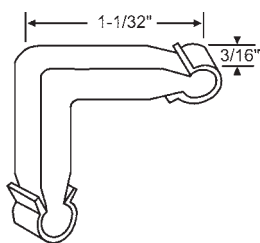

**46-11**  
Universal. Die Cast

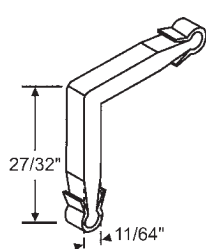

**46-124**  
Die Cast

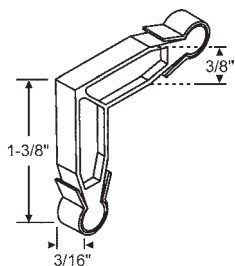

**900-17541**  
Metal

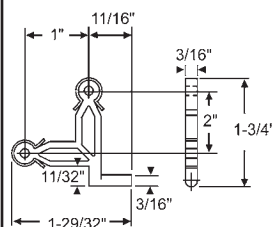

**900-17541T**  
Tilt Window Screen Corner  
Traco

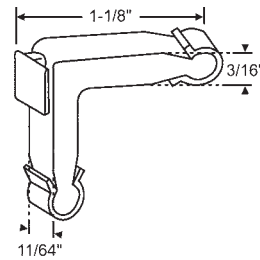

**46-9**  
Die Cast  
Capitol

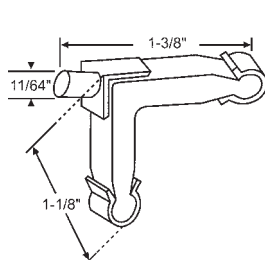

**46-8**  
Die Cast  
Capitol

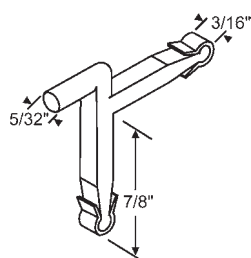

**46-125**  
Die Cast

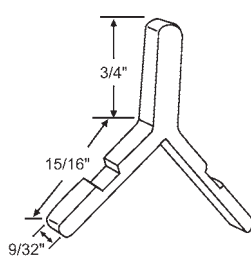

**46-21**  
Aluminum

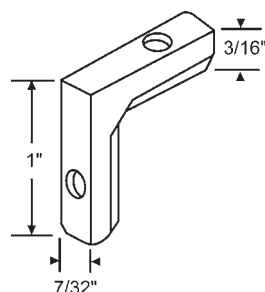

**46-12**  
Die Cast

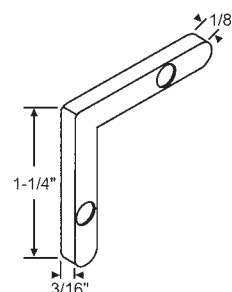

**900-479**  
Die Cast

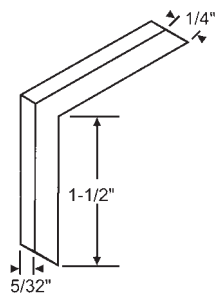

**900-14556**  
Metal

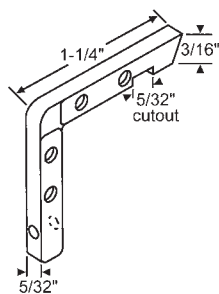

**900-11892**  
Metal

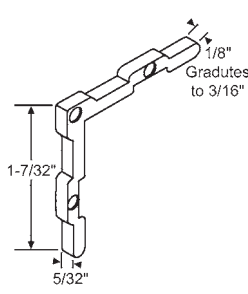

**900-11008**  
Metal

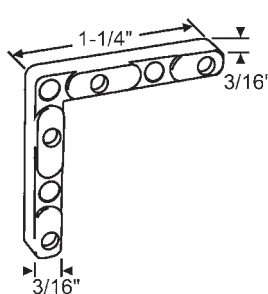

**900-481**  
Die Cast

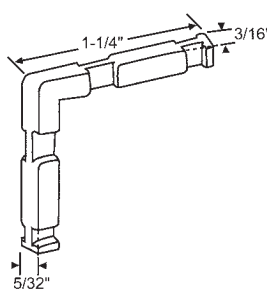

**46-66**  
Die Cast

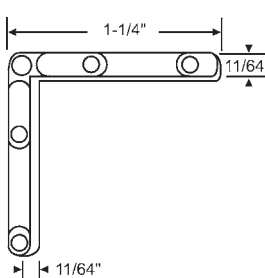

**900-15214**  
Die Cast

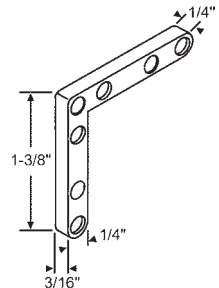

**900-12611**  
Die Cast

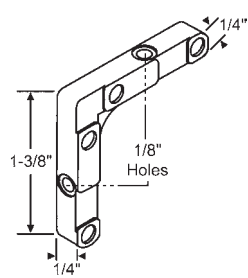

**900-14537**  
Die Cast

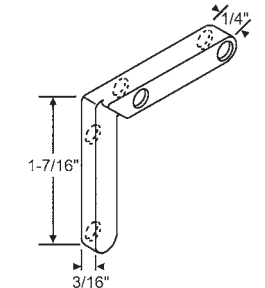

Part #	Hand
900-12612LH	Shown
900-12612RH	Opposite

Die Cast

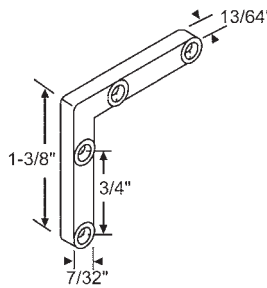

**900-21287**  
Die Cast

# Window Replacement Hardware

## Corner Keys

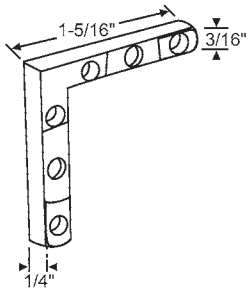

**46-86**  
Die Cast

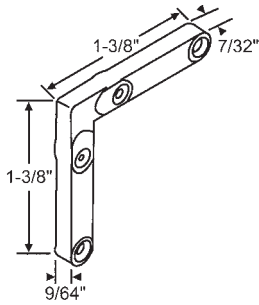

**46-80**  
Die Cast

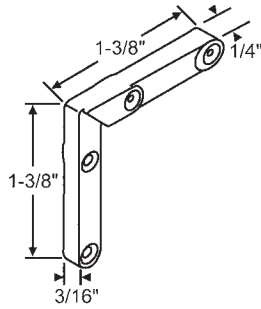

**46-82A**  
Sold in Sets Only  
LH Shown. Die Cast

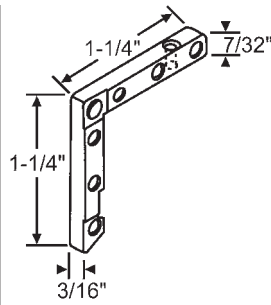

**46-120**  
Die Cast

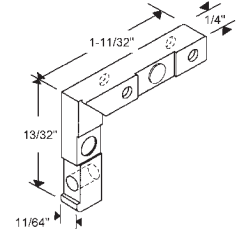

Part #	Hand
900-19065	Shown
900-19066	Opposite

Die Cast

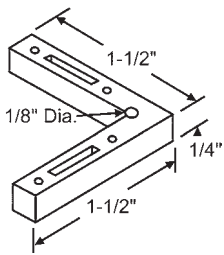

**900-7303**  
Crossly

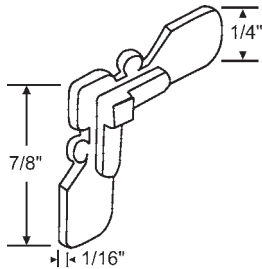

**46-25**  
Metal

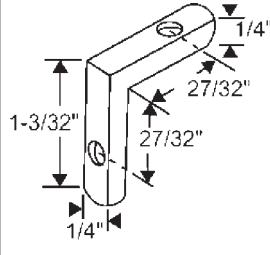

**46-263**  
Zinc Die Cast  
Harcar

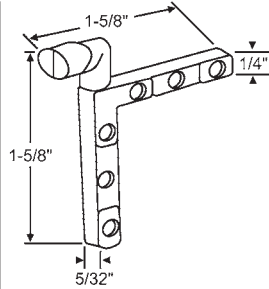

**46-27A**  
Die Cast  
Sold in Sets Only  
1RH (Shown) & LH

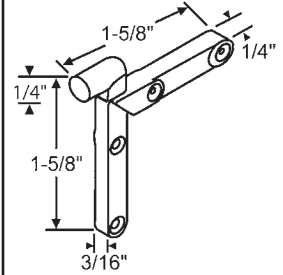

Part #	Hand
46-85	Shown
46-84	Opposite

Die Cast

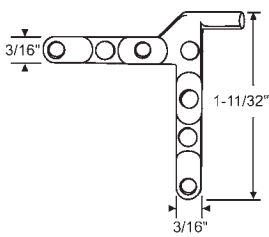

**46-303**  
Metal Corner Key  
Pair (LH & RH)

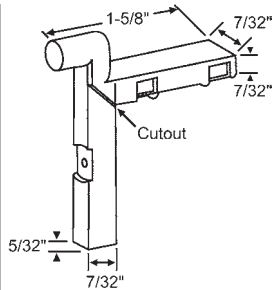

Part #	Hand
46-90	Shown
46-89	Opposite

Die Cast

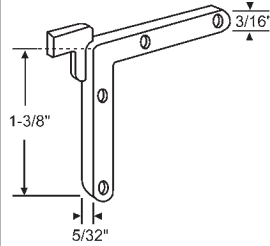

**46-7**  
Die Cast

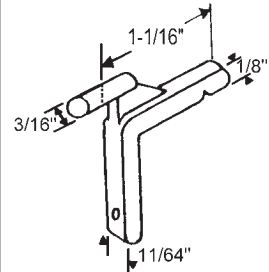

**46-142**  
Die Cast  
With Hole & Screw

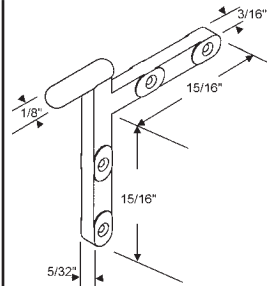

**900-18318**  
Corner Key  
Die Cast

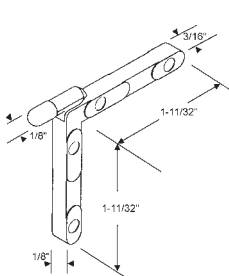

**900-464**  
Die Cast

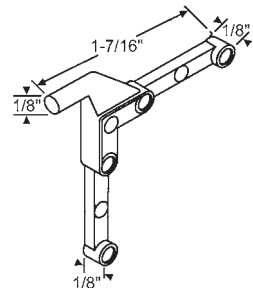

Part #	Hand
900-17595LH	Shown
900-17595RH	Opposite

Metal Corner Swivel

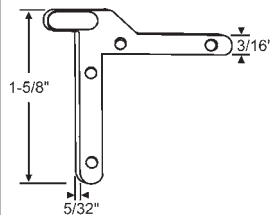

**900-11012**  
Corner Key Pair (LH/RH)  
Die Cast

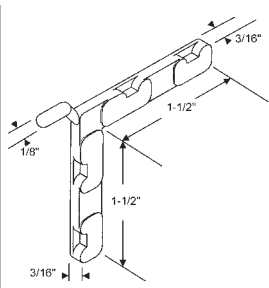

Part #	Hand
900-11924LH	Shown
900-11924RH	Opposite

Die Cast

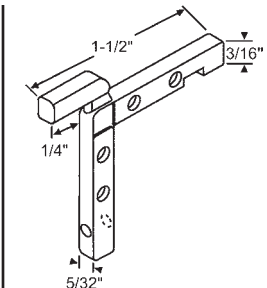

**900-11893**  
Metal

# Window Replacement Hardware

## Corner Keys

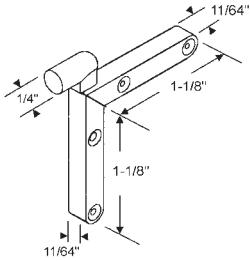

Part #	Hand
900-12613LH	Shown
900-12613RH	Opposite

Die Cast

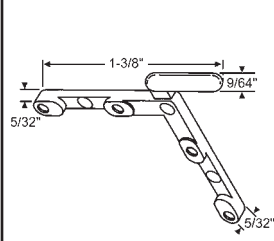

**900-19063**  
Metal

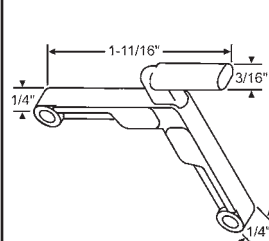

**900-19067**  
Die Cast, Gray

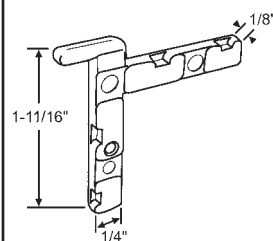

Part #	Hand
900-456LH	Shown
900-456RH	Opposite

Metal Tilt Key

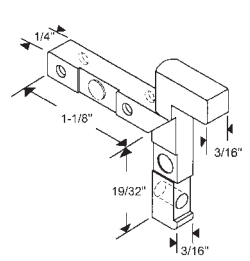

**900-19068**  
Die Cast

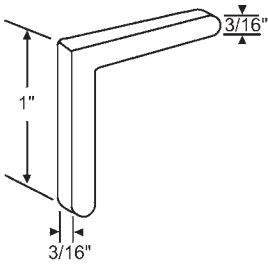

**46-19**  
Nylon

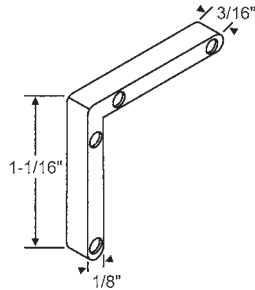

**46-121**  
Plastic  
Seasonall

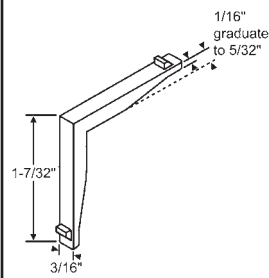

**46-138**  
Nylon

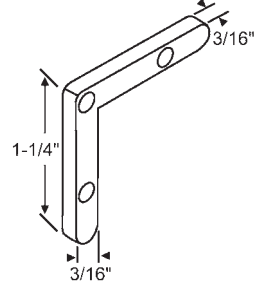

**900-2229**  
Universal  
Nylon

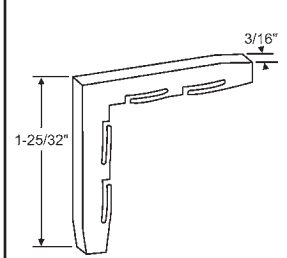

**900-19237**  
White  
Plastic

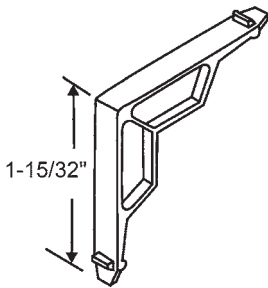

**900-2251**  
Nylon

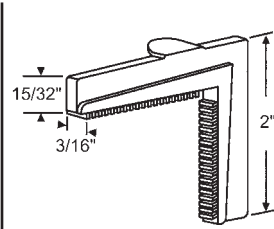

Part #	Hand
900-2256	Shown
900-2257	Opposite

Nylon

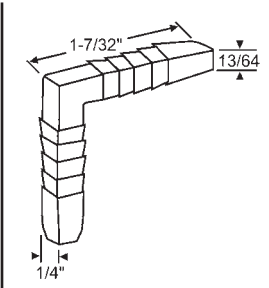

**900-2278**  
Natural Nylon

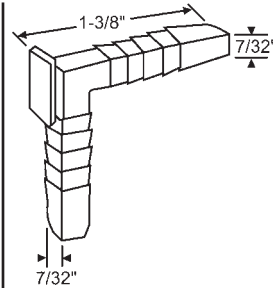

**46-20**  
Universal  
Nylon

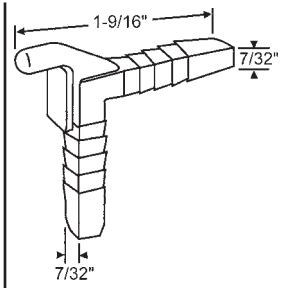

**46-26**  
Nylon

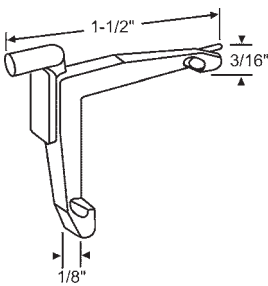

**46-17**  
Universal  
Nylon

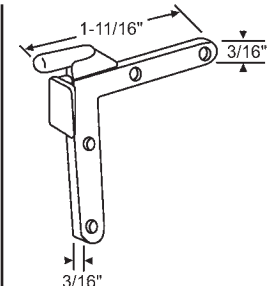

**46-18B**  
Nylon  
Black

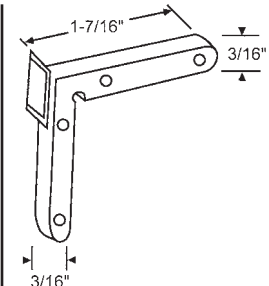

**900-2209**  
Universal  
Nylon

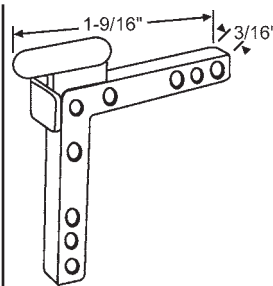

**46-163**  
Nylon Tilt Key

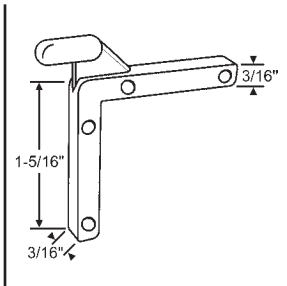

**46-285**  
Universal  
White Nylon

# Window Replacement Hardware

## Corner Keys, Tilt Keys

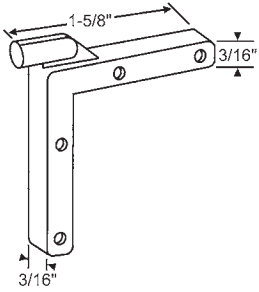

**900-2157**  
Plastic Tilt Key

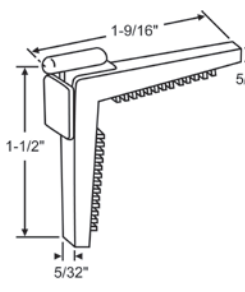

**900-2269**  
Plastic Tilt Key  
Black

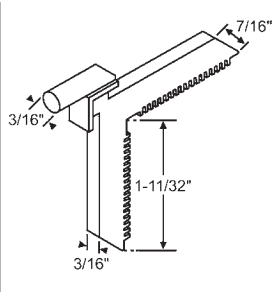

**900-15773**  
Plastic Tilt Corner Key

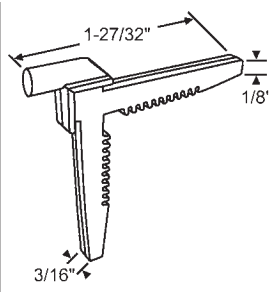

**46-107**  
White Nylon. Saw Tooth Design

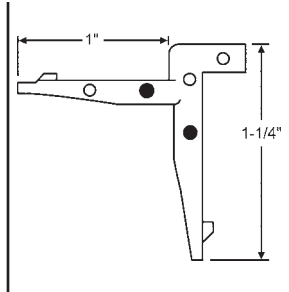

**46-137**  
Nylon with Edge

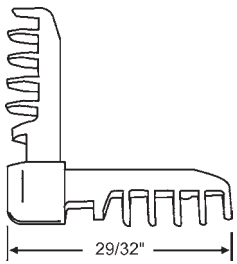

**46-269**  
White Nylon

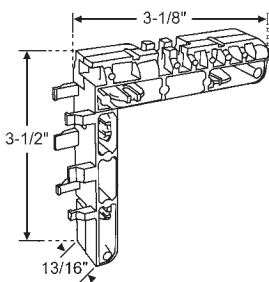

**900-19043**  
White Plastic

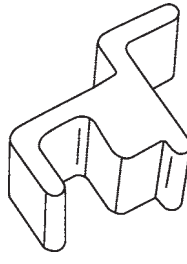

**900-21654**  
Storm Sash Control Button  
Metal

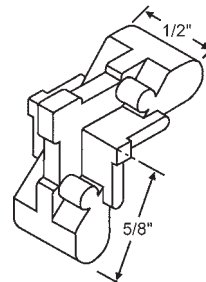

**900-14559**  
Die Cast

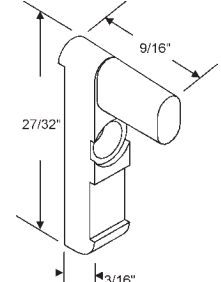

**900-10188**  
Pivot Key without Screw  
Metal

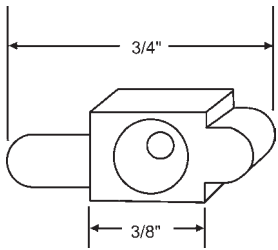

**900-5359**  
Tilt Key. Nylon  
Black  
Alenco

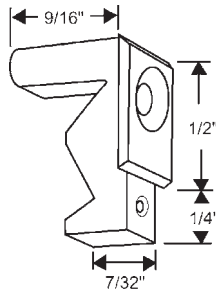

**900-5941**  
Natural Nylon Tilt Key

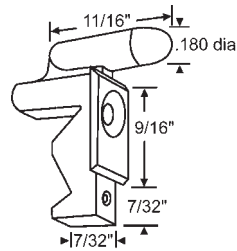

**900-5939**  
Nylon Tilt Key  
Gallitan

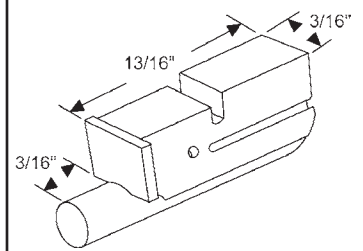

**900-2353**  
Tilt Key  
Nylon

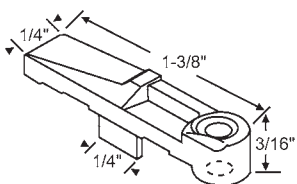

Part #	Hand
900-12102	Shown
900-12101	Opposite

Die Cast. Storm Window & Door Anti-Bow  
Latch For Wood Windows  
Seasonall

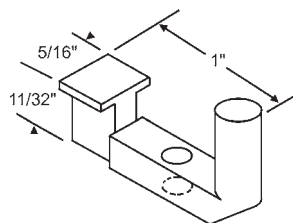

**46-116**  
White  
Nylon Tilt Key  
Sugarcreek

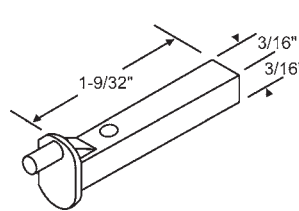

**900-2331**  
Plastic Tilt Key

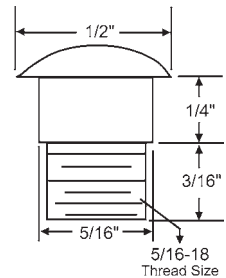

**900-8530**  
Shoulder Bolt

### C-Sash Components Make Assembly and Installation Easy.

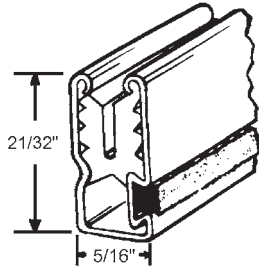

8 Ft. Lengths - 100 lengths per carton

Part #	Color
90-492B-8	Bronze
90-492M-8	Mill
90-492W-8	White

12 Ft. Lengths - 100 lengths per carton

Part #	Color
90-492B-12	Bronze
90-492M-12	Mill
90-492W-12	White

8 Ft. Lengths - 20 lengths per carton

Part #	Color
90-496B-8	Bronze
90-496M-8	Mill
90-496W-8	White

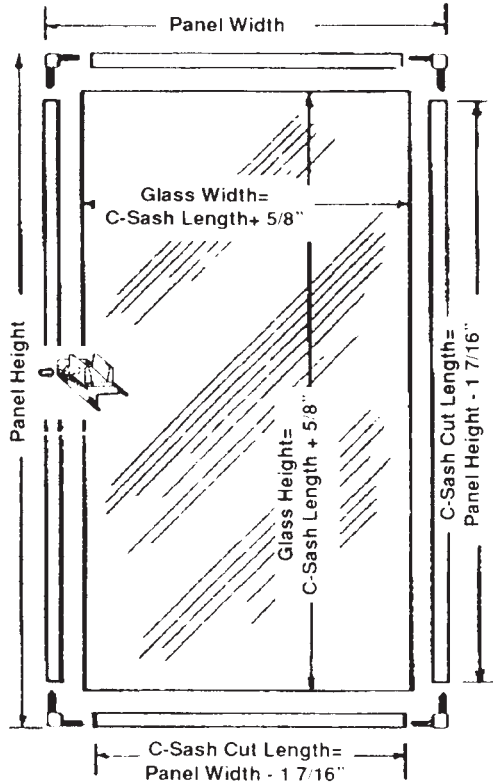

**Press-Lock™** Corners eliminate the need for mitering. Just push into a square-cut corner, no need for staking. Made of high-impact ABS.

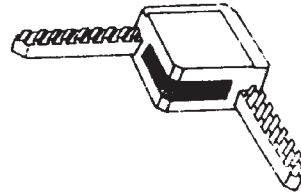

Part #	Color
90-489M	Mill
90-489B	Bronze
90-489W	White

**Slide-Lock™** Fasteners, the preferred inside fastening system, give a professional finished look. The slide bolt inserts into a brass fitting for positive, reliable attachment. When the panel is removed, only the recessed brass fitting remains. There are no unattractive magnetic or plastic tapes left on the window frame. Available in colors to match C-sash.

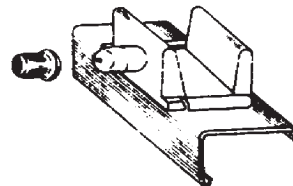

Part #	Color
90-490M	Mill
90-490B	Bronze
90-490W	White

C-Sash® has been a proven performer in the storm window and storm door industry for years. Its unique roll-formed combination of aluminum, gasketing and weatherstripping reduce fabrication time and simplify inventory control. This reliable framing member can be used for:

- External Storm Panels
- Internal Window Panels
- Additional Thermal Protection for Picture and Bay Windows
- Storm Door Window Panels
- Up to 1/8" Glass Thickness

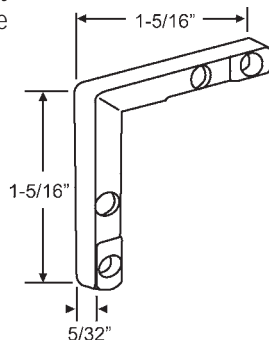

**Sill Expander** A vinyl section which includes pile weather-strip, slides onto the C-sash frame to correct for sill irregularities and to provide weatherscaling along the base of frame.



Part #	Color
90-491B	Bronze
90-491W	White

Includes twenty-five 40" pieces

\*Note C-Sash cut lengths = Panel Width - 5/8"

900-15214

**Die Cast Corner Key** Zinc Die Cast used for mitered corners.